

Duet™ S 2

525mm

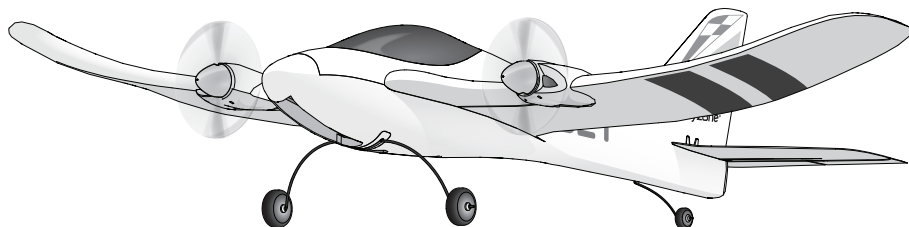

Scan the QR code and select the Manuals and Support quick links from the product page for the most up-to date manual information.

Scannen Sie den QR-Code und wählen Sie auf der Produktseite die Quicklinks Handbücher und Unterstützung, um die aktuellsten Informationen zu Handbücher.

Scannez le code QR et sélectionnez les liens rapides Manuals and Support sur la page du produit pour obtenir les informations les plus récentes sur le manuel.

Scannerizzare il codice QR e selezionare i Link veloci Manuali e Supporto dalla pagina del prodotto per le informazioni manuali più aggiornate.



HBZ05300

**Instruction Manual | Bedienungsanleitung
Manuel d'utilisation | Manuale di Istruzioni**

NOTICE

All instructions, warranties and other collateral documents are subject to change at the sole discretion of Horizon Hobby, Inc. For up-to-date product literature, visit www.horizonhobby.com and click on the support tab for this product.

Meaning of Special Language:

The following terms are used throughout the product literature to indicate various levels of potential harm when operating this product:

NOTICE: Procedures, which if not properly followed, create a possibility of physical property damage AND little or no possibility of injury.

CAUTION: Procedures, which if not properly followed, create the probability of physical property damage AND a possibility of serious injury.

WARNING: Procedures, which if not properly followed, create the probability of property damage, collateral damage, and serious injury OR create a high probability of superficial injury.

 **WARNING:** Read the ENTIRE instruction manual to become familiar with the features of the product before operating. Failure to operate the product correctly can result in damage to the product, personal property and cause serious injury.

This is a sophisticated hobby product. It must be operated with caution and common sense and requires some basic mechanical ability. Failure to operate this product in a safe and responsible manner could result in injury or damage to the product or other property. This product is not intended for use by children without direct adult supervision. Do not use with incompatible components or alter this product in any way outside of the instructions provided by Horizon Hobby, Inc. This manual contains instructions for safety, operation and maintenance. It is essential to read and follow all the instructions and warnings in the manual, prior to assembly, setup or use, in order to operate correctly and avoid damage or serious injury.

Age Recommendation: Not for children under 14 years. This is not a toy.

Safety Precautions and Warnings

This model is controlled by a radio signal subject to interference from many sources outside of your control. Interference can cause momentary loss of flight control.

As the user of this product, you are solely responsible for operating in a manner that does not endanger yourself and others or result in damage to the product or the property of others.

- **NEVER** operate the aircraft under the influence of drugs or alcohol.
- **NEVER** place any portion of the model in your mouth as it could cause serious injury or even death.
- **NEVER** operate the aircraft with damaged wiring or components.
- **NEVER** touch moving parts.
- **NEVER** operate the aircraft in the rain.
- **NEVER** fly over people, roadways, structures, power lines or near airports.
- **NEVER** attempt to fly from a vehicle or from within a structure.
- **NEVER** perform maintenance on the aircraft with the battery installed.
- **NEVER** use a damaged or deformed battery.
- **ALWAYS** treat the motor and propeller as if they are armed and could start at any time.
- **ALWAYS** ensure the transmitter is secure before and while the aircraft is powered on.
- **ALWAYS** keep body parts and loose clothing well clear of the propeller/rotor blades.
- **ALWAYS** keep the aircraft securely restrained in case of accidental throttle activation.
- **ALWAYS** perform a maintenance check on the aircraft and transmitter prior to and after every flight to ensure airworthiness.
- **ALWAYS** operate the aircraft in open spaces, away from full-size vehicles, traffic and people.
- **ALWAYS** keep the aircraft in sight and under control.

- **ALWAYS** keep a safe distance in all directions around your model to avoid collisions or injury.
- **ALWAYS** fully reduce the throttle or activate throttle cut before a crash.
- **ALWAYS** keep the transmitter powered on when the aircraft is powered on.
- **ALWAYS** carefully follow the directions and warnings for this and any optional support equipment (chargers, rechargeable battery packs, etc.).
- **ALWAYS** keep all chemicals, small parts and anything electrical out of the reach of children.
- **ALWAYS** use fully charged batteries.
- **ALWAYS** let parts cool after use before touching.
- **ALWAYS** keep moving parts clean.
- **ALWAYS** keep parts dry.
- **ALWAYS** remove batteries after use.

As of this printing, you are required to register with the FAA if you fly this product.

For up-to-date information on how to register with the FAA, please visit <https://registermyuas.faa.gov/>.

For additional assistance on regulations and guidance on UAS usage, visit knowbeforeyoufly.org/.

Specifications	
Wingspan	20.6 inch (523.3mm)
Length	14.5 inch (368.4mm)
Weight*	Without Battery: 1.3oz (38g) With Recommended 1S 150mAh Flight Battery: 1.5oz (43g)

* The weight provided is for the aircraft and flight control components. No additional payload is allowed. MTOM is weight with recommended battery.



This product is a class C4 UAS as defined by the European Union Aviation Safety Agency (EASA).

Table of Contents

Transmitter	4	After Flying	10
Installing the Transmitter Batteries	4	Trouble Shooting Guide	11
Charging the Flight Battery	5	Propeller Service	12
Installing the Flight Battery	5	Binding	12
Control Direction Test	6	AMA National Model Aircraft Safety Code	13
SAFE® Technology Flight Modes	7	Limited Warranty	14
Hand Launch	8	Warranty and Service Information	15
Ground Takeoff	8	FCC Information	16
Flying	9	IC Information	16
Adjusting Trim in Flight	9	Compliance Information for the European Union	17
Manual Adjusting Trim	10		
Landing	10		

Charging Warning

⚠ CAUTION: All instructions and warnings must be followed exactly. Mishandling of Li-Po batteries can result in a fire, personal injury and/or property damage.

- By handling, charging or using the included Li-Po battery, you assume all risks associated with lithium batteries.
- If at any time the battery begins to balloon or swell, discontinue use immediately. If charging or discharging, discontinue and disconnect. Continuing to use, charge or discharge a battery that is ballooning or swelling can result in fire.
- Always store the battery at room temperature in a dry area for best results.
- Always transport or temporarily store the battery in a temperature range of 40–120° F. Do not store the battery or model in a car or direct sunlight. If stored in a hot car, the battery can be damaged or even catch fire.
- Always charge batteries away from flammable materials.
- Always inspect the battery before charging.
- Always disconnect the battery after charging, and let the charger cool between charges.
- Always constantly monitor the temperature of the battery pack while charging.
- **ONLY USE A CHARGER SPECIFICALLY DESIGNED TO CHARGE LI-PO BATTERIES.** Failure to charge the battery with a compatible charger may cause a fire resulting in personal injury and/or property damage.
- Never discharge Li-Po cells to below 3V under load.

- Never cover warning labels with hook and loop strips.
- Never leave charging batteries unattended.
- Never charge batteries outside recommended levels.
- Never charge damaged batteries.

- Never attempt to dismantle or alter the charger.
- Never allow minors to charge battery packs.
- Never charge batteries in extremely hot or cold places (recommended between 40–120° F or 5–49° C) or place in direct sunlight.

Transmitter

Low Battery Alarm

When the battery voltage drops too low, an alarm sounds and the LED flashes. The batteries must be replaced immediately. If this happens while flying, land your aircraft as soon and as safely as possible.

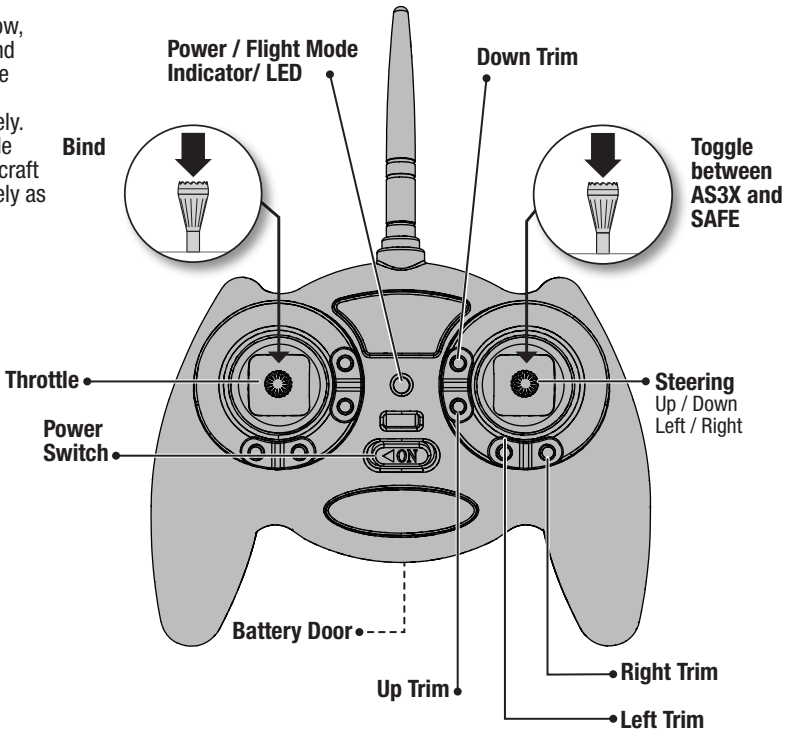

Installing the Transmitter Batteries

Install 4 AA batteries into the transmitter, noting polarity. Replace the transmitter batteries when the power LED flashes and the transmitter beeps.

We recommend using only alkaline AA batteries in the transmitter, however, it is possible to use rechargeable NiMH batteries.

CAUTION: If using rechargeable batteries, charge only rechargeable batteries. Charging non-rechargeable batteries may cause the batteries to burst, resulting in injury to persons and/or damage to property.

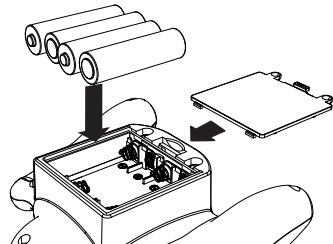

Charging the Flight Battery

NOTICE: Inspect the battery to make sure it is not damaged e.g., swollen, bent, broken or punctured. Charge only batteries that are cool to the touch and are not damaged.

Always charge the aircraft battery before flying.

1. Insert the charger into a USB port.
2. Connect the battery to the charger.

CHARGING (Solid Red LED)
MAX CHARGE (LED OFF)

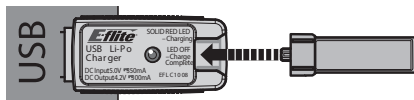
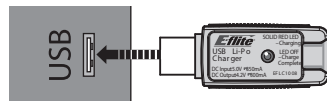

Disconnect the flight battery from the charger immediately upon completion of charging.

CAUTION: Only use chargers specifically designed to charge the included Li-Po battery. Failure to do so could result in fire, causing injury or property damage.

CAUTION: Never exceed the recommended charge rate.

CAUTION: Once charging is complete, immediately remove the battery. Never leave a battery connected to the charger.

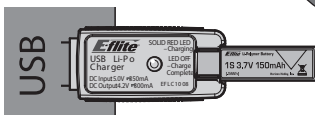

Installing the Flight Battery

Keep the aircraft and transmitter away from large metal objects, wireless sources or other transmitters while installing the battery.

Each time the aircraft initializes from a power cycle, it will default to SAFE mode.

CAUTION: Always disconnect the Li-Po flight battery from the aircraft receiver when not flying to avoid over-discharging the battery. Batteries discharged to a voltage lower than the lowest approved voltage may become damaged, resulting in loss of performance and potential fire when batteries are charged.

CAUTION: Always keep hands away from the propellers. Stabilization will turn propellers in response to any aircraft movement, once initialized by moving throttle up above 25%. After one full second of zero throttle, and zero movement of the aircraft, the stabilization will turn off.

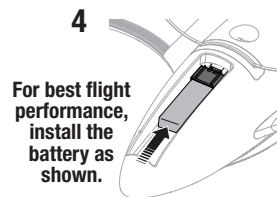
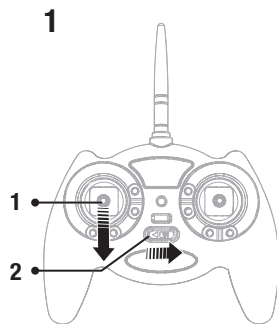
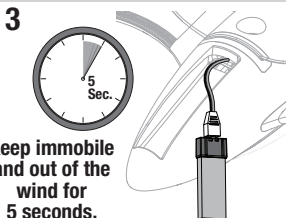
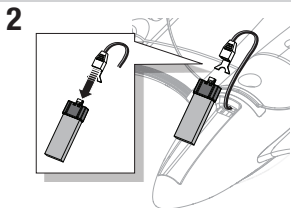

Control Direction Test

1. Face the aircraft away from you.
2. Restrain the aircraft so it does not escape your control while you are testing your transmitter controls.
3. Move the sticks on the transmitter to ensure the aircraft responds as shown.

Refer to the Binding instructions and Troubleshooting Guide in this manual for more information.

If you need more assistance, contact the appropriate Horizon Hobby Product Support department.

Up Elevator (climb)

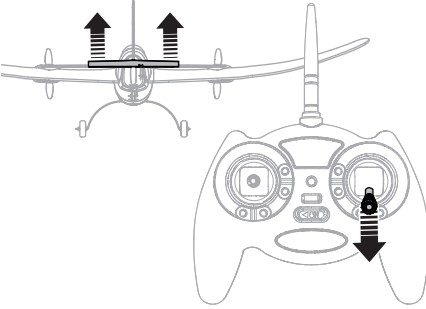

Down Elevator (descend)

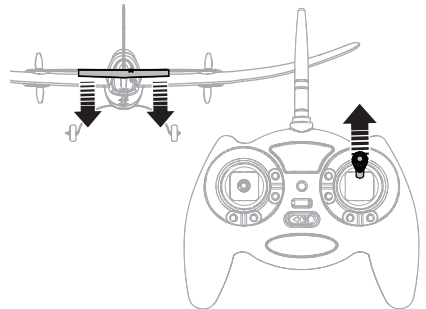

Turn Right

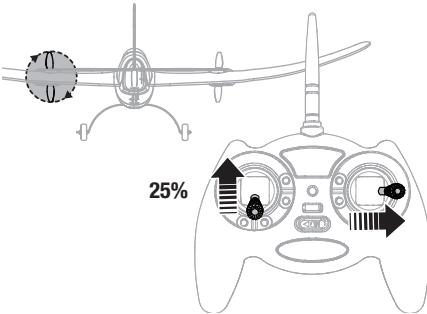

Turn Left

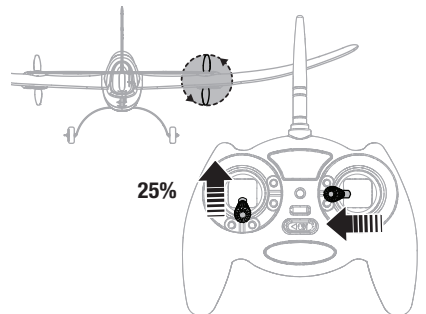

SAFE® Technology Flight Modes

When toggling between Safe® Mode and AS3X® Mode, the following tones and LEDS will be provided by the transmitter to indicate the aircraft flight mode.

- SAFE Mode: two beeps and the LED will flash blue.
- AS3X Mode: one beep and the LED will flash red.

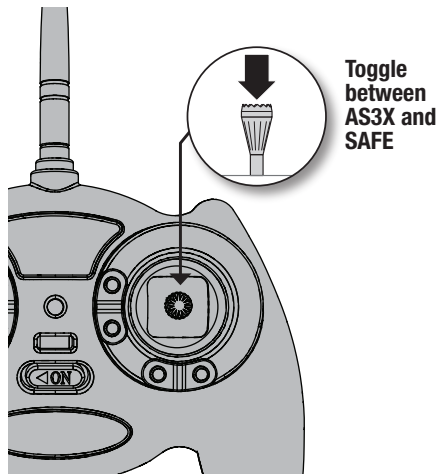

SAFE Mode (with self leveling)

Pitch (nose up and down) and Roll (wing tips up and down) angles are limited to help you keep the aircraft airborne. Release both sticks for self-leveling.

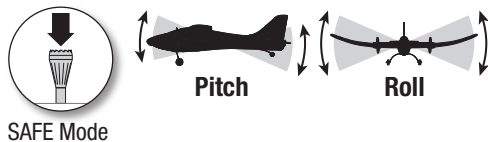

AS3X Mode

Unlimited Flight Envelope

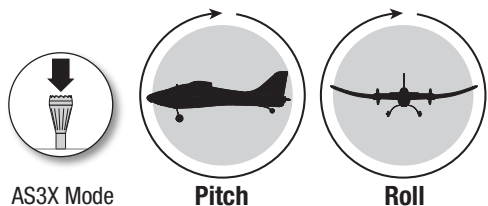

Hand Launch

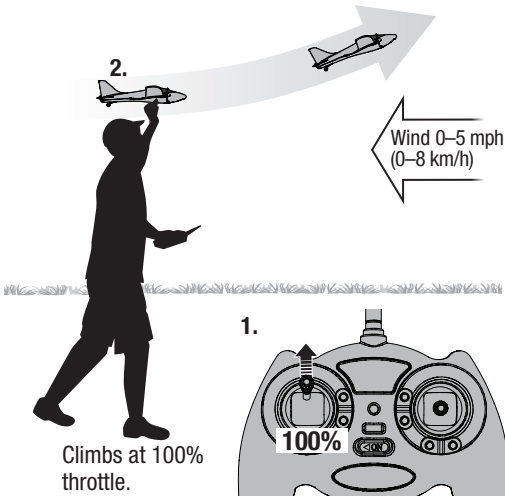

Always start with a fully charged battery.

Get help to hand launch your aircraft so you can concentrate on flying. If you must hand launch the aircraft alone, hold the model in your dominant hand and the transmitter in your other hand.

Ground Takeoff

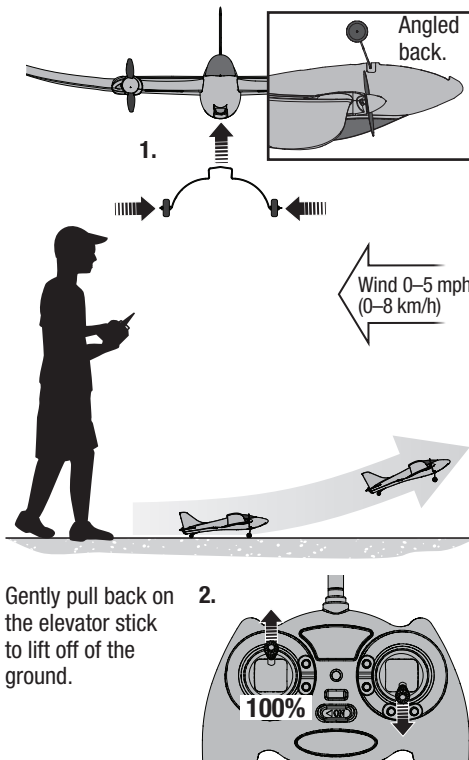

Always start with a fully charged battery.

Install the landing gear as shown. Takeoff from a hard and level runway. Turn the aircraft only after it is high off the ground.

Flying

- Set a flight timer for 5 minutes
- Always make deliberate and steady control stick movements for smooth control of your aircraft. If you feel you are losing control, release the right (steering) stick to allow the aircraft to return to level flight.
- When you notice that the aircraft no longer climbs while under full power or the motors begin to pulse, immediately land the aircraft and recharge the battery.
- The transmitter LED will alert you to the charge status of the aircraft's flight battery.

-**FULL CHARGE** (Green LED)

-**PARTIAL CHARGE** (Yellow LED)

-**LOW CHARGE** (Red LED)

When the LED is red, you should land immediately and recharge the flight battery. The aircraft will soon enter low-voltage cut-off. Once low-voltage cut-off is reached, the aircraft motors will pulse power followed by a complete removal of power to the motors.

- When in SAFE mode, the aircraft will climb with throttle above 70%, and descend when throttle is below 30%. It will fly straight and level between 30% and 70% throttle.

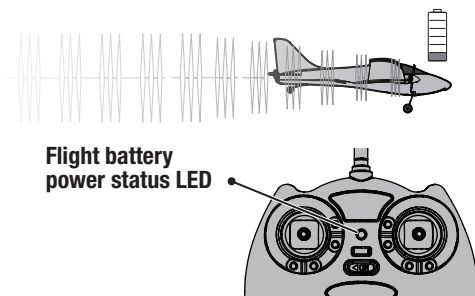
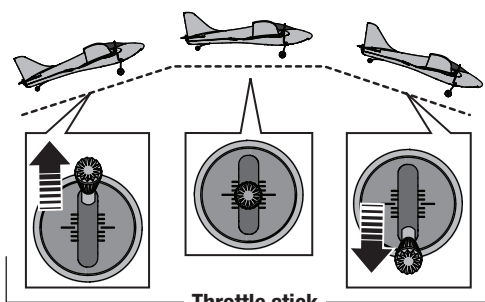

Adjusting Trim in Flight

Familiarize yourself with your transmitter's controls and the aircraft's response before flying by performing the recommended Control Direction Test. Press the trim buttons on your transmitter to adjust how the aircraft flies.

If the aircraft's nose drifts while the steering stick is at neutral (centered) and the throttle is at 50%, press the trim buttons:

- Upper button to stop up drift
- Lower button to stop down drift
- Left button to stop right drift
- Right button to stop left drift

If you press a trim button until no beep sounds and the aircraft does not fly straight and level, land and manually adjust the trim as described below.

Direction of Drift	Button to Correct

Manual Adjusting Trim

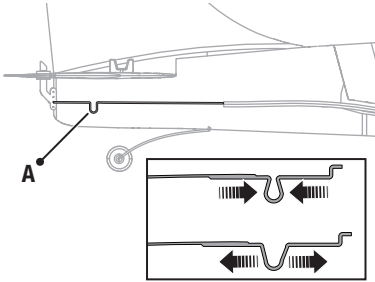

Press the trim buttons to return to center (3 beeps will sound), then use a pair of pliers to carefully bend the metal connector (A):

- Narrow if the aircraft's nose drifts up.
- Widen if the aircraft's nose drifts down.

Short test flights and small bends may be needed.

Landing

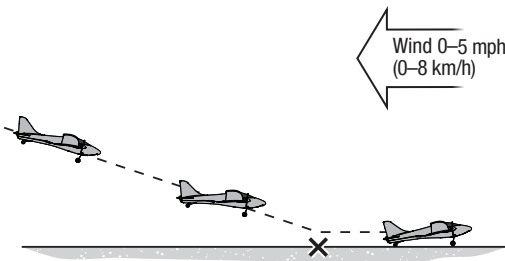

Fly to your runway, keeping the aircraft pointed into the wind and the wings level. Bring the aircraft down by lowering the throttle to 25%. Near the ground, fully lower the throttle and pull back on the steering stick.

CAUTION: Never catch a flying aircraft in your hands. Doing so could cause personal injury and damage to the aircraft.

After Flying

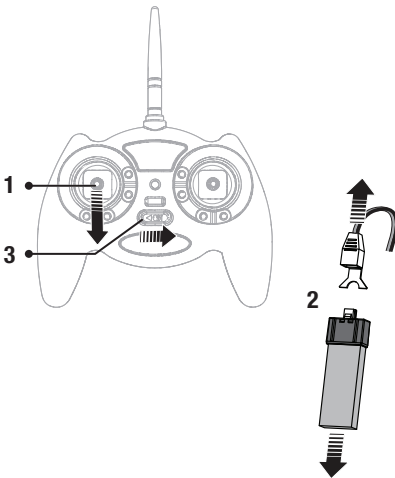

1. Lower the throttle stick completely and do not move the steering stick. Wait at least 5 seconds.
2. Disconnect and remove the battery from the aircraft. Keep hands away from the propellers.
3. Power off the transmitter.
4. Fully charge the aircraft battery.
5. Remove the battery after charging is complete.

NOTICE: When you are finished flying, never leave the aircraft in direct sunlight or in a hot, enclosed area such as a car. Doing so can damage the foam.

NOTICE: Always disconnect the battery from the aircraft before powering off the transmitter or injury and damage may result.

Trouble Shooting Guide

Problem	Possible Cause	Solution
Aircraft does not respond to the transmitter	No connection	Follow Binding Instructions. Follow "Installing the Flight Battery" instructions. Replace or recharge batteries
	Transmitter too near the aircraft or both are too near large metal objects, wireless sources or another transmitter during battery connection or Binding	Move to another location, with the transmitter more than 24 inches (60 cm) from the aircraft and attempt battery connection or Binding again
	Low or no power	Replace or recharge batteries and correctly connect the aircraft battery
Poor aircraft response to the transmitter	Poor radio connection	Replace or recharge batteries
	Poor control adjustment or damage to the aircraft	Adjust steering by using left or right trim buttons or land immediately and adjust, repair or replace parts
	Aircraft was moved during battery connection	Keep aircraft immobile during battery connection
Aircraft turns in one direction	Poor control adjustment or damage to the aircraft	Adjust steering by using the left or right trim buttons or land immediately and adjust, repair or replace parts
	Wind is too gusty or strong	Fly on a calmer day
Aircraft rises steeply at half throttle	Poor control adjustment or damage to the aircraft	Adjust by pressing the down trim button or land. Manually adjust trim.
	Aircraft battery is incorrectly installed	Install aircraft battery fully back
	Wind is too gusty or strong	Fly on a calmer day
Aircraft will not climb	Poor control adjustment or damage to the aircraft	Adjust by pressing the up trim button or land. Manually adjust trim.
	Propellers or spinners are loose or damaged	Land immediately and adjust, repair or replace parts
	Low or no power	Replace or recharge batteries
Aircraft is difficult to launch in the wind	Gusty or cross winds	Launch directly into the wind
Flight time is too short	Battery is not fully charged or is damaged	Recharge or replace the battery
	Propellers or spinners are loose or damaged	Land immediately and adjust, repair or replace parts
	Flying at full throttle during entire flight	Fly at just above half throttle to increase flying time
	Wind speed is too fast for safe flight	Fly on a calmer day
Aircraft vibrates	Propellers or spinners are loose or damaged	Land immediately and adjust, repair or replace parts

Propeller Service

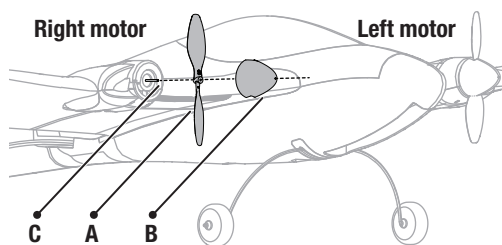

⚠ CAUTION: DO NOT handle propeller parts while the flight battery is connected. Personal injury could result.

1. Remove the spinner (A) by carefully pulling it away from the propeller (B). Remove residue from the spinner and propeller if applicable.
2. Remove the propeller from the motor shaft, noting the "L" or "R" indicator. Use a pair of needle nose pliers or hemostats to hold the motor shaft (C) in place, then carefully pull the propeller from the motor shaft.
3. Install a new propeller with the size numbers facing out from the motor.
 - 4.75 x 2.5 R (Right)
 - 4.75 x 2.5 L (Left)
4. Reinstall the spinner using foam safe CA (Cyanoacrylate adhesive).

A list of available replacement parts is in the back of the manual. Visit the web site www.hobbyzonerc.com for more information about maintaining your aircraft.

Binding

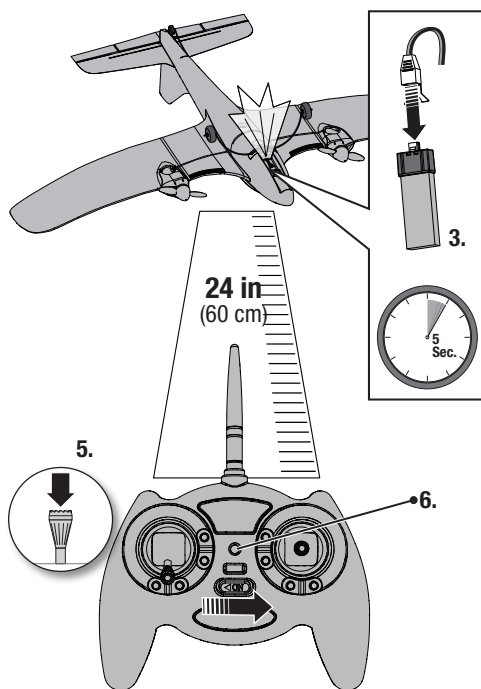

If your aircraft does not respond to the transmitter when the batteries in the aircraft and transmitter are fully charged, bind your aircraft and transmitter by using the instructions below.

1. Disconnect the flight battery from the aircraft.
2. Power off the transmitter.
3. Connect the flight battery to the aircraft. The receiver LED will begin to flash (typically after 5 seconds)
4. Hold the transmitter more than 24 inches (60 cm) away from the aircraft. Keep away from large metal objects, wireless sources and other transmitters. Make sure your transmitter's controls are neutral, the throttle is in the low position, and the aircraft is immobile.
5. Push the left control stick into the case until it clicks, as you power on the transmitter.
6. The transmitter will beep twice and the LED will flash. Release the stick after 2 seconds.
7. After 5 to 10 seconds, the receiver status LED will begin flashing slowly and the transmitter will stop beeping, indicating the receiver is bound to the transmitter.

AMA National Model Aircraft Safety Code

Effective January 1, 2018

A model aircraft is a non-human-carrying device capable of sustained flight within visual line of sight of the pilot or spotter(s). It may not exceed limitations of this code and is intended exclusively for sport, recreation, education and/or competition. All model flights must be conducted in accordance with this safety code and related AMA guidelines, any additional rules specific to the flying site, as well as all applicable laws and regulations.

As an AMA member I agree:

- I will not fly a model aircraft in a careless or reckless manner.
- I will not interfere with and will yield the right of way to all human-carrying aircraft using AMA's See and Avoid Guidance and a spotter when appropriate.
- I will not operate any model aircraft while I am under the influence of alcohol or any drug that could adversely affect my ability to safely control the model.
- I will avoid flying directly over unprotected people, moving vehicles, and occupied structures.
- I will fly Free Flight (FF) and Control Line (CL) models in compliance with AMA's safety programming.
- I will maintain visual contact of an RC model aircraft without enhancement other than corrective lenses prescribed to me. When using an advanced flight system, such as an autopilot, or flying First-Person View (FPV), I will comply with AMA's Advanced Flight System programming.
- I will only fly models weighing more than 55 pounds, including fuel, if certified through AMA's Large Model Airplane Program.
- I will only fly a turbine-powered model aircraft in compliance with AMA's Gas Turbine Program.
- I will not fly a powered model outdoors closer than 25 feet to any individual, except for myself or my helper(s) located at the flightline, unless I am taking off and landing, or as otherwise provided in AMA's Competition Regulation.
- I will use an established safety line to separate all model aircraft operations from spectators and bystanders.

Limited Warranty

What this Warranty Covers

Horizon Hobby, LLC, (Horizon) warrants to the original purchaser that the product purchased (the "Product") will be free from defects in materials and workmanship at the date of purchase.

What is Not Covered

This warranty is not transferable and does not cover (i) cosmetic damage, (ii) damage due to acts of God, accident, misuse, abuse, negligence, commercial use, or due to improper use, installation, operation or maintenance, (iii) modification of or to any part of the Product, (iv) attempted service by anyone other than a Horizon Hobby authorized service center, (v) Product not purchased from an authorized Horizon dealer, or (vi) Product not compliant with applicable technical regulations, or (vii) use that violates any applicable laws, rules, or regulations.

OTHER THAN THE EXPRESS WARRANTY ABOVE, HORIZON MAKES NO OTHER WARRANTY OR REPRESENTATION, AND HEREBY DISCLAIMS ANY AND ALL IMPLIED WARRANTIES, INCLUDING, WITHOUT LIMITATION, THE IMPLIED WARRANTIES OF NON-INFRINGEMENT, MERCHANTABILITY AND FITNESS FOR A PARTICULAR PURPOSE. THE PURCHASER ACKNOWLEDGES THAT THEY ALONE HAVE DETERMINED THAT THE PRODUCT WILL SUITABLY MEET THE REQUIREMENTS OF THE PURCHASER'S INTENDED USE.

Purchaser's Remedy

Horizon's sole obligation and purchaser's sole and exclusive remedy shall be that Horizon will, at its option, either (i) service, or (ii) replace, any Product determined by Horizon to be defective. Horizon reserves the right to inspect any and all Product(s) involved in a warranty claim. Service or replacement decisions are at the sole discretion of Horizon. Proof of purchase is required for all warranty claims. SERVICE OR REPLACEMENT AS PROVIDED UNDER THIS WARRANTY IS THE PURCHASER'S SOLE AND EXCLUSIVE REMEDY.

Limitation of Liability

HORIZON SHALL NOT BE LIABLE FOR SPECIAL, INDIRECT, INCIDENTAL OR CONSEQUENTIAL DAMAGES, LOSS OF PROFITS OR PRODUCTION OR COMMERCIAL LOSS IN ANY WAY, REGARDLESS OF WHETHER SUCH CLAIM IS BASED IN CONTRACT, WARRANTY, TORT, NEGLIGENCE, STRICT LIABILITY OR ANY OTHER THEORY OF LIABILITY, EVEN IF HORIZON HAS BEEN ADVISED OF THE POSSIBILITY OF SUCH DAMAGES. Further, in no event shall the

liability of Horizon exceed the individual price of the Product on which liability is asserted. As Horizon has no control over use, setup, final assembly, modification or misuse, no liability shall be assumed nor accepted for any resulting damage or injury. By the act of use, setup or assembly, the user accepts all resulting liability. If you as the purchaser or user are not prepared to accept the liability associated with the use of the Product, purchaser is advised to return the Product immediately in new and unused condition to the place of purchase.

Law

These terms are governed by Illinois law (without regard to conflict of law principals). This warranty gives you specific legal rights, and you may also have other rights which vary from state to state. Horizon reserves the right to change or modify this warranty at any time without notice.

WARRANTY SERVICES

Questions, Assistance, and Services

Your local hobby store and/or place of purchase cannot provide warranty support or service. Once assembly, setup or use of the Product has been started, you must contact your local distributor or Horizon directly. This will enable Horizon to better answer your questions and service you in the event that you may need any assistance. For questions or assistance, please visit our website at www.horizonhobby.com, submit a Product Support Inquiry, or call the toll free telephone number referenced in the Warranty and Service Contact Information section to speak with a Product Support representative.

Inspection or Services

If this Product needs to be inspected or serviced and is compliant in the country you live and use the Product in, please use the Horizon Online Service Request submission process found on our website or call Horizon to obtain a Return Merchandise Authorization (RMA) number. Pack the Product securely using a shipping carton. Please note that original boxes may be included, but are not designed to withstand the rigors of shipping without additional protection. Ship via a carrier that provides tracking and insurance for lost or damaged parcels, as Horizon is not responsible for merchandise until it arrives and is accepted at our facility. An Online Service Request is available at http://www.horizonhobby.com/content/service-center_render-service-center. If you do not have internet access, please contact Horizon Product Support to obtain a RMA number along with

instructions for submitting your product for service. When calling Horizon, you will be asked to provide your complete name, street address, email address and phone number where you can be reached during business hours. When sending product into Horizon, please include your RMA number, a list of the included items, and a brief summary of the problem. A copy of your original sales receipt must be included

for warranty consideration. Be sure your name, address, and RMA number are clearly written on the outside of the shipping carton.

NOTICE: Do not ship LiPo batteries to Horizon. If you have any issue with a LiPo battery, please contact the appropriate Horizon Product Support office.

Warranty and Service Information

Country of Purchase	Horizon Hobby	Contact Information	Address
United States of America	Horizon Service Center (Repairs and Repair Requests)	servicecenter.horizonhobby.com/RequestForm/	2904 Research Rd Champaign, Illinois, 61822 USA
	Horizon Product Support (Product Technical Assistance)	productsupport@horizonhobby.com 877-504-0233	
	Sales	websales@horizonhobby.com 800-338-4639	
European Union	Horizon Technischer Service	service@horizonhobby.eu	Hanskampring 9 D 22885 Barsbüttel, Germany
	Sales: Horizon Hobby GmbH	+49 (0) 4121 2655 100	

FCC Information

FCC ID: BRWHBZ5303 and BRWHBZ9505

This equipment complies with FCC and IC radiation exposure limits set forth for an uncontrolled environment. This equipment should be installed and operated with minimum distance 20cm between the radiator and/or antenna and your body (excluding fingers, hands, wrists, ankles and feet). This transmitter must not be co-located or operating in conjunction with any other antenna or transmitter.

Supplier's Declaration of Conformity

HBZ Duet S 2 RTF (HBZ05300)

 This device complies with part 15 of the FCC Rules. Operation is subject to the following two conditions: (1) This device may not cause harmful interference, and (2) this device must accept any interference received, including interference that may cause undesired operation.



CAUTION: Changes or modifications not expressly approved by the party responsible for compliance could void the user's authority to operate the equipment.

NOTE: This equipment has been tested and found to comply with the limits for a Class B digital device, pursuant to part 15 of the FCC Rules. These limits are designed to provide reasonable protection against harmful interference in a residential installation. This equipment generates, uses and can radiate radio frequency energy and, if not installed and used in accordance with the instructions, may cause harmful interference to radio communications. However, there is no guarantee that interference will not occur in a particular installation. If this equipment does cause harmful interference to radio or television reception, which can be determined by turning the equipment off and on, the user is encouraged to try to correct the interference by one or more of the following measures:

- Reorient or relocate the receiving antenna.
- Increase the separation between the equipment and receiver.
- Connect the equipment into an outlet on a circuit different from that to which the receiver is connected.
- Consult the dealer or an experienced radio/TV technician for help.

Horizon Hobby, LLC

2904 Research Rd.,
Champaign, IL 61822

Email: compliance@horizonhobby.com

Web: HorizonHobby.com

IC Information

IC: 6157A-HBZ5303 and 6157A-HBZ9505

CAN ICES-3 (B)/NMB-3(B)

This device contains license-exempt transmitter(s)/receivers(s) that comply with Innovation, Science, and Economic Development Canada's license-exempt RSS(s). Operation is subject to the following 2 conditions:

1. This device may not cause interference.
2. This device must accept any interference, including interference that may cause undesired operation of the device.

Compliance Information for the European Union



EU Compliance Statement:

HBZ Duet S 2 RTF (HBZ05300); Hereby, Horizon Hobby, LLC declares that the device is in compliance with the following: Radio Equipment Directive (RED) 2014/53/EU; Low Voltage Directive (LVD) 2014/35/EU; 2014/30/EU EMC Directive; RoHS 2 Directive 2011/65/EU; RoHS 3 Directive - Amending 2011/65/EU Annex II 2015/863.

The full text of the EU declaration of conformity is available at the following internet address:

<https://www.horizonhobby.com/content/support-render-compliance>.

Wireless Frequency Range and Wireless Output Power:

Transmitter:

2405-2475MHz

9.66Bm

Receiver:

2405-2475MHz

9.82dBm

NOTE: This product contains batteries that are covered under the 2006/66/EC European Directive, which cannot be disposed of with normal household waste. Please follow local regulations.

EU Manufacturer of Record:

Horizon Hobby, LLC
2904 Research Road
Champaign, IL 61822 USA

EU Importer of Record:

Horizon Hobby, GmbH
Hanskampring 9
22885 Barsbüttel Germany

WEEE NOTICE:



This appliance is labeled in accordance with European Directive 2012/19/EU concerning waste of electrical and electronic equipment (WEEE). This label indicates that this product should not be disposed of with household waste.





© 2023 Horizon Hobby, LLC

HobbyZone, the HobbyZone logo, Apprentice, SAFE, the SAFE logo, AS3X, DSM, DSM2, DSMX, IC3, Bind-N-Fly, the BNF logo, the Smart Technology logo, and the Horizon Hobby logo are trademarks or registered trademarks of Horizon Hobby, LLC. The Spektrum trademark is used with permission of Bachmann Industries, Inc.

US 8,672,726. US 9,056,667. US 9,753,457. US 10,078,329. US 9,930,567. US 10,419,970. US 10,849,013. CN201721563463.4. Other patents pending.

www.horizonhobby.com