



S1400 G2 AC Smart Charger (1 x 400W)



Instruction Manual
Bedienungsanleitung
Manuel d'utilisation
Manuale di Istruzioni



NOTICE

All instructions, warranties and other collateral documents are subject to change at the sole discretion of Horizon Hobby, LLC. For up-to-date product literature, visit horizonhobby.com or towerhobbies.com and click on the support or resources tab for this product.

Meaning of Special Language

The following terms are used throughout the product literature to indicate various levels of potential harm when operating this product:

WARNING: Procedures, which if not properly followed, create the probability of property damage, collateral damage, and serious injury OR create a high probability of superficial injury.

CAUTION: Procedures, which if not properly followed, create the probability of physical property damage AND a possibility of serious injury.

NOTICE: Procedures, which if not properly followed, create a possibility of physical property damage AND little or no possibility of injury.

Age Recommendation: Not for children under 14 years. This is not a toy.



WARNING: Read the ENTIRE instruction manual to become familiar with the features of the product before operating. Failure to operate the product correctly can result in damage to the product, personal property and cause serious injury.

This is a sophisticated hobby product. It must be operated with caution and common sense and requires some basic mechanical ability. Failure to operate this product in a safe and responsible manner could result in injury or damage to the product or other property. This product is not intended for use by children without direct adult supervision. Do not attempt disassembly, use with incompatible components or alter product in any way without the approval of Horizon Hobby, LLC. This manual contains instructions for safety, operation and maintenance. It is essential to read and follow all the instructions and warnings in the manual, prior to assembly, setup or use, in order to operate correctly and avoid damage or serious injury.

NOTICE: This appliance is not intended for use by persons with reduced physical, sensory or mental capabilities, or lack of experience and knowledge, unless they have been given supervision or instruction concerning use of the appliance by a person responsible for their safety.



DANGER: To reduce the risk of fire or electric shock, carefully follow these instructions.

General Charging Warnings



WARNING: Failure to exercise caution while using this product and comply with the following warnings could result in product malfunction, electrical issues, excessive heat, FIRE, and ultimately injury and property damage.

- **NEVER LEAVE CHARGING BATTERIES UNATTENDED DURING USE.**
- **NEVER CHARGE BATTERIES OVERNIGHT.**
- Never attempt to charge dead, damaged or wet battery packs.
- Never attempt to charge a battery pack containing different types of batteries.
- Never allow children under 14 years of age to charge battery packs.
- Never charge batteries in extremely hot or cold places or place in direct sunlight.
- Never charge a battery if the cable has been pinched or shorted.
- Never connect the charger if the power cable has been pinched or shorted.
- Never connect the charger to an automobile 12V battery while the vehicle is running.
- Never attempt to dismantle the charger or use a damaged charger.
- Never attach your charger to both an AC and a DC power source at the same time.
- Never connect the input jack (DC input) to AC power.
- Always use only rechargeable batteries designed for use with this type of charger in the correct programming mode.
- Always inspect the battery before charging.
- Always keep the battery away from any material that could be affected by heat.
- Always monitor the charging area and have a fire extinguisher available at all times.

- Always end the charging process if the battery becomes hot to the touch or starts to change form (swell) during the charge process.
- Always connect the charge cable to the charger first, then connect the battery to avoid short circuit between the charge leads. Reverse the sequence when disconnecting.
- Always connect the positive red leads (+) and negative black leads (-) correctly.
- Always disconnect the battery after charging, and let the charger cool between charges.
- Always charge in a well-ventilated area.
- Always terminate all processes and contact Horizon Hobby if the product malfunctions.
- Charge only rechargeable batteries. Charging non-rechargeable batteries may cause the batteries to burst, resulting in injury to persons and/or damage to property.
- The socket-outlet shall be installed near the equipment and shall be easily accessible.

WARNING: Never leave charger unattended, exceed maximum charge rate, charge with non-approved batteries or charge batteries in the wrong mode. Failure to comply may result in excessive heat, fire and serious injury.

CAUTION: Always ensure the battery you are charging meets the specifications of this charger and that the charger settings are correct. Not doing so can result in excessive heat and other related product malfunctions, which can lead to user injury or property damage. Please contact Horizon Hobby or an authorized retailer with compatibility questions.

Specifications

Output Port Connector	IC3® and IC5® (EC3™/EC5™ compatible)
Input Voltage (required power supply)	AC 100–240V
Charge Current	0.1 - 20.0A
Discharge Current	0.1 - 1.5A
Max. Charge Power	400W
Max. Discharge Power	10W
Balance Current	1.5A/cell

Balance Cells	1–6S
Supported Battery Types (cell count)	LiFe/LiIon/LiPo/LiHv (1–6S) NiMH/Cd (1–16S) Pb (1–12S)
Display	2.4" 320 × 240 IPS LCD
Operating Temperature	0–40°C (32–104°F)

Diagram

A	Power ON/OFF Switch
B	Power Input (AC 100–240V)
C	USB In (Update Port)
D	USB Out (Power Port)
E	Display Screen
F	Menu Up/Down Buttons
G	Menu Back Button

H	IC3/IC5 Charge Port Slider
I	Menu Select Button
J	Balance Port
K	IC5 Battery Charge Port
L	IC3 Battery Charge Port

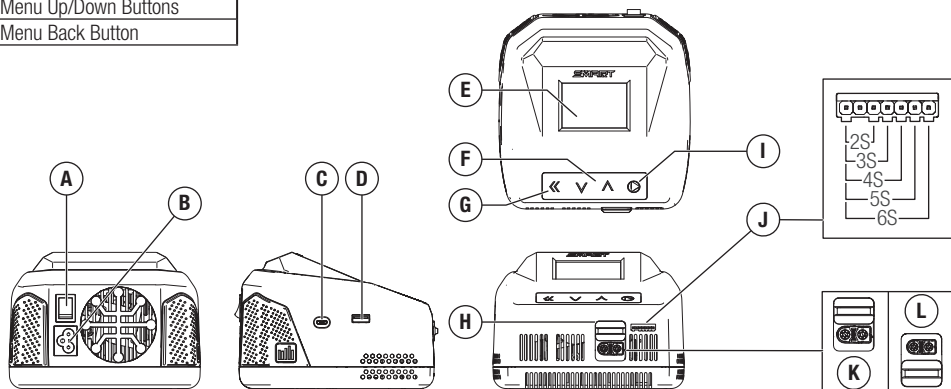

Navigating the Charger

Basic navigation of the charger menus is accomplished using the push button menu scroll arrows and select button.

- Press the down arrow button to scroll down a menu list.
- Press the up arrow button to scroll up a menu list.
- Press the menu selection button to select a menu item.
- While on the home screen, press and hold the menu selection button to enter the charger settings menu.



Up and Down Buttons



Back Button Menu /
Select
Button

Operating the Charger

Before operating the charger, know your battery's specifications and any battery-specific safety warnings.

1. Connect the included AC cord to the charger and appropriate power supply to power on your S1400 Smart Charger. Turn ON the charger using the ON & OFF switch located on the back of the charger. The charger will initialize and display the home screen after switching the charger to "ON".
2. Connect the battery to the port on the front of the charger.
3. Connect the battery balance lead, if available, to the balance port on the right side of the IC3 and IC5 port. Make sure the balance lead is positioned correct all the way to the left side of the balance port.

Smart Batteries: If charging a Spektrum Smart Battery, the Battery Cell Count, Battery Type, Battery Charge Current Rate and Battery Capacity are set automatically and the charger will begin charging automatically when the battery and the balance lead (if available) are connected to the charger. G1 Spektrum Smart batteries are compatible with G2 Spektrum Smart chargers.

4. Press and release the menu button to display the Charger Settings list:

Charger Settings	
Task	Select Charge, Discharge, or Storage
Battery (Type)	Select the appropriate battery chemistry
Cells (Cell Count)	Set the number of cells in the battery (this value auto-detects if using a Spektrum™ Smart battery or if the battery balance lead is connected to the balance port)
Current	Set the charge current
Start	Start the charge cycle
Smart Battery Settings	Configure the settings on your Smart battery
System Settings	Charger settings
Charger History	Displays number of charger cycles on the day, total number of cycles, charger temperature, and input power

Select the desired **Task**.

5. Confirm the settings are correct for the battery being charged.

WARNING: Always check charging parameters before initiating the charge process. Charging any battery with improper settings, including charging a battery in the wrong mode, can result in property damage and fire.

6. Scroll to the **Start** menu item.

7. Press and release the menu button to begin charging.

During the charging process:

1. While the battery is charging the main screen will provide:
 - Charged percent
 - Battery data
 - Charge rate
 - Capacity charged
 - Charge time remaining (Smart batteries only)
 - Total charge time
2. Scroll to the next screen to see additional cell voltage information.
3. Scroll to the last screen to see the battery's internal resistance.
4. When the fast charge cycle is complete, the charger will beep once and the Battery Bar will change to green. The charger is balancing the battery cells.

To stop the charging cycle:

1. Press and release the back button during the charge or press and hold the menu button.
2. Select the **Stop** menu item. The charger will stop charging and return to the ready screen.















WARNING: Always stop the charging cycle or remove power supplied to the charger if you notice any irregularities (like a swollen battery) during charging.













When charging is complete:

The charger will be once to indicate the fast charging is done. Once the charger is finished balancing the battery's cells it will double beep twice.

1. The main screen will display a green battery bar at the top to indicate the battery is full and the charging process has finished.
2. The total capacity charged and total charge time will be displayed
3. Disconnect the battery from the charger. The battery is ready and the charger will return to the home screen.

Screen Icons

Icon	Description
	Charging
	Current
	Task
	Start
	Back
	Forward
	Input Power
	Settings (Battery/System)
	Temperature
	Date
	Internal Resistance
	Battery History
	Mode

Icon	Description
	Input Voltage
	Output Voltage
	Storage Voltage
	Backlight
	Volume
	Touch Sensitivity
	Completion Tone
	Fault/Error/Fault Log
	Cycles
	No Battery Detected
	Charger/ Charger History
	Info
	Chemistry

Smart Settings

The Smart selection is available if a Smart battery is connected. Smart settings include:

Auto Storage	Select to run Auto Storage function with a delay between 12 and 240 hours
Charge Current	Change the default charge current for your Smart battery
Charge Voltage	Select the charge voltage for your Smart battery
Storage Voltage	Select the storage voltage for each cell
Battery History	Provides number of battery cycles, battery temp and production date.
Fault Log	Provides a list of faults, including over-voltage, under-voltage or over-temperature, and the date of exception.
Back	Return to the home screen

System Settings

Backlight	Low, Medium, High
Volume	Off, Low, Middle, High
Completion Tone	Single or Repeat
Touch Sensitivity	Low, High
Language	Select language
System Self-Checking	Initiates a charger self check. Do not connect a battery to the output port while self check is running.
System Information	View the charger's firmware version
Back	Return to the home screen

Charger Errors

If the charger displays an error, follow the on-screen prompts to remedy the error. If necessary, disconnect the battery from the output and balance ports, disconnect the power supply, and restart the charger.

* Visit the S1400 Smart Charger's product page on www.horizonhobby.com for more information about the charger, firmware updates and optional accessories.

Limited Warranty

What this Warranty Covers – Horizon Hobby, LLC, (Horizon) warrants to the original purchaser that the product purchased (the “Product”) will be free from defects in materials and workmanship for a period of 1 year from the date of purchase.

What is Not Covered – This warranty is not transferable and does not cover (i) cosmetic damage, (ii) damage due to acts of God, accident, misuse, abuse, negligence, commercial use, or due to improper use, installation, operation or maintenance, (iii) modification of or to any part of the Product, (iv) attempted service by anyone other than a Horizon Hobby authorized service center, (v) Product not purchased from an authorized Horizon dealer, or (vi) Product not compliant with applicable technical regulations or (vii) use that violates any applicable laws, rules, or regulations.

OTHER THAN THE EXPRESS WARRANTY ABOVE, HORIZON MAKES NO OTHER WARRANTY OR REPRESENTATION, AND HEREBY DISCLAIMS ANY AND ALL IMPLIED WARRANTIES, INCLUDING, WITHOUT LIMITATION, THE IMPLIED WARRANTIES OF NON-INFRINGEMENT, MERCHANTABILITY AND FITNESS FOR A PARTICULAR PURPOSE. THE PURCHASER ACKNOWLEDGES THAT THEY ALONE HAVE DETERMINED THAT THE PRODUCT WILL SUITABLY MEET THE REQUIREMENTS OF THE PURCHASER’S INTENDED USE.

Purchaser’s Remedy – Horizon’s sole obligation and purchaser’s sole and exclusive remedy shall be that Horizon will, at its option, either (i) service, or (ii) replace, any Product determined by Horizon to be defective. Horizon reserves the right to inspect any and all Product(s) involved in a warranty claim. Service or replacement decisions are at the sole discretion of Horizon. Proof of purchase is required for all warranty claims. SERVICE OR REPLACEMENT AS PROVIDED UNDER THIS WARRANTY IS THE PURCHASER’S SOLE AND EXCLUSIVE REMEDY.

Limitation of Liability – HORIZON SHALL NOT BE LIABLE FOR SPECIAL, INDIRECT, INCIDENTAL OR CONSEQUENTIAL DAMAGES, LOSS OF PROFITS OR PRODUCTION OR COMMERCIAL LOSS IN ANY WAY, REGARDLESS OF WHETHER SUCH CLAIM IS BASED IN CONTRACT, WARRANTY, TORT, NEGLIGENCE, STRICT LIABILITY OR ANY OTHER THEORY OF LIABILITY, EVEN IF HORIZON HAS BEEN ADVISED OF THE POSSIBILITY OF SUCH DAMAGES. Further, in no event shall the liability of Horizon exceed the individual price of the Product on which liability is asserted. As Horizon has no control over use, setup, final assembly, modification or misuse, no liability shall be assumed nor accepted for any resulting damage or injury. By the act of use, setup or assembly, the user accepts all resulting liability. If you as the purchaser or user are not prepared to accept the liability associated with the use of the Product, purchaser is advised to return the Product immediately in new and unused condition to the place of purchase.

Law – These terms are governed by Illinois law (without regard to conflict of law principals). This warranty gives you specific legal rights, and you may also have other rights which vary from state to state. Horizon reserves the right to change or modify this warranty at any time without notice.

WARRANTY SERVICES

Questions, Assistance, and Services – Your local hobby store and/or place of purchase cannot provide warranty support or service. Once assembly, setup or use of the Product has been started, you must contact your local distributor or Horizon directly. This will enable Horizon to better answer your questions and service you in the event that you may need any assistance. For questions or assistance, please visit our website at www.horizonhobby.com, submit a Product Support Inquiry, or call the toll free telephone number referenced in the Warranty and Service Contact Information section to speak with a Product Support representative.

Inspection or Services – If this Product needs to be inspected or serviced and is compliant in the country you live and use the Product in, please use the Horizon Online Service Request submission process found on our website or call Horizon to obtain a Return Merchandise Authorization (RMA) number. Pack the Product securely using a shipping carton. Please note that original boxes may be included, but are not designed to withstand the rigors of shipping without additional protection. Ship via a carrier that provides tracking and insurance for lost or damaged parcels, as Horizon is not responsible for merchandise until it arrives and is accepted at our facility. An Online Service Request is available at http://www.horizonhobby.com/content/service-center_render-service-center. If you do not have internet access, please contact Horizon Product Support to obtain a RMA number along with instructions for submitting your product for service. When calling Horizon, you will be asked to provide your complete name, street address, email address and phone number where you can be reached during business hours. When sending product into Horizon, please include your RMA number, a list of the included items, and a brief summary of the problem. A copy of your original sales receipt must be included for warranty consideration. Be sure your name, address, and RMA number are clearly written on the outside of the shipping carton.

NOTICE: Do not ship Li-Po batteries to Horizon. If you have any issue with a Li-Po battery, please contact the appropriate Horizon Product Support office.

Warranty Requirements – For Warranty consideration, you must include your original sales receipt verifying the proof-of-purchase date. Provided warranty conditions have been met, your Product will be serviced or replaced free of charge. Service or replacement decisions are at the sole discretion of Horizon.

Non-Warranty Service – Should your service not be covered by warranty, service will be completed and payment will be required without notification or estimate of the expense unless the expense exceeds 50% of the retail purchase cost. By submitting the item for service you are agreeing to payment of the service without notification. Service estimates are available upon request. You must include this request with your item submitted for service. Non-warranty service estimates will be billed a minimum of ½ hour of labor. In addition you will be billed for return freight. Horizon accepts money orders and cashier’s checks, as well as Visa, MasterCard, American Express, and Discover cards. By submitting any item to Horizon for service, you are agreeing to Horizon’s Terms and Conditions found on our website http://www.horizonhobby.com/content/service-center_render-service-center.

ATTENTION: Horizon service is limited to Product compliant in the country of use and ownership. If received, a non-compliant Product will not be serviced. Further, the sender will be responsible for arranging return shipment of the un-serviced Product, through a carrier of the sender’s choice and at the sender’s expense. Horizon will hold non-compliant Product for a period of 60 days from notification, after which it will be discarded.

10/15

Warranty and Service Contact Information

Country of Purchase	Horizon Hobby	Contact Information	Address
United States of America	Horizon Service Center (Repairs and Repair Requests)	servicecenter.horizonhobby.com/RequestForm/	2904 Research Road Champaign, Illinois, 61822 USA
	Horizon Product Support (Product Technical Assistance)	productsupport@horizonhobby.com 877-504-0233	
	Sales	websales@horizonhobby.com 800-338-4639	
European Union	Horizon Technischer Service Sales: Horizon Hobby GmbH	service@horizonhobby.eu +49 (0) 4121 2655 100	Hanskampring 9 D 22885 Barsbüttel, Germany

FCC Information

Supplier's Declaration of Conformity

S1400 G2 AC Smart Charger (SPMXC2040)

FC This device complies with part 15 of the FCC rules. Operation is subject to the following two conditions: (1) this device may not cause harmful interference, and (2) this device must accept any interference received, including interference that may cause undesired operation.

CAUTION: Changes or modifications not expressly approved by the party responsible for compliance could void the user's authority to operate the equipment.

NOTE: This equipment has been tested and found to comply with the limits for a Class B digital device, pursuant to part 15 of the FCC Rules. These limits are designed to provide reasonable protection against harmful interference in a residential installation. This equipment generates, uses and can radiate radio frequency energy and, if not installed and used in accordance

with the instructions, may cause harmful interference to radio communications. However, there is no guarantee that interference will not occur in a particular installation. If this equipment does cause harmful interference to radio or television reception, which can be determined by turning the equipment off and on, the user is encouraged to try to correct the interference by one or more of the following measures:

- Reorient or relocate the receiving antenna.
- Increase the separation between the equipment and receiver.
- Connect the equipment into an outlet on a circuit different from that to which the receiver is connected.
- Consult the dealer or an experienced radio/TV technician for help.

Horizon Hobby, LLC
2904 Research Road
Champaign, IL 61822
Email: compliance@horizonhobby.com
Web: HorizonHobby.com

IC Information

ICES-3 (B)/NMB-3(B)

Compliance Information for the European Union

CE **EU Compliance Statement:**
S1400 G2 AC Smart Chager (SPMXC2040):
Hereby, Horizon Hobby, LLC declares that the device is in compliance with the following: EU Low Voltage Directive 2014/35/EU and EU EMC Directive 2014/30/EU.

The full text of the EU declaration of conformity is available at the following internet address: <https://www.horizonhobby.com/content/support-render-compliance>.

EU Manufacturer of Record:

Horizon Hobby, LLC
2904 Research Road
Champaign, IL 61822 USA

EU Importer of Record:

Horizon Hobby, GmbH
Hanskampring 9
22885 Barsbüttel Germany

WEEE NOTICE:



This appliance is labeled in accordance with European Directive 2012/19/EU concerning waste of electrical and electronic equipment (WEEE). This label indicates that this product should not be disposed of with household waste. It should be deposited at an appropriate facility to enable recovery and recycling.





© 2020 Horizon Hobby, LLC.

IC3, IC5, EC3, EC5, the Smart Technology logo and the Horizon Hobby logo are trademarks or registered trademarks of Horizon Hobby, LLC.

The Spektrum trademark is used with permission of Bachmann Industries, Inc.

All other trademarks, service marks and logos are property of their respective owners.

CN201721563463.4. Other patents pending.

Created 08/20

SPMXC2040

64408