

BLADE[™]
#1 BY DESIGN

Scout CX[™]



Engineered By The Experts in
RC Helicopter Performance

RTF
READY-TO-FLY

NOTICE

All instructions, warranties and other collateral documents are subject to change at the sole discretion of Horizon Hobby, Inc. For up-to-date product literature, visit horizonhobby.com and click on the support tab for this product.

Meaning of Special Language

The following terms are used throughout the product literature to indicate various levels of potential harm when operating this product:

NOTICE: Procedures, which if not properly followed, create a possibility of physical property damage AND a little or no possibility of injury.

CAUTION: Procedures, which if not properly followed, create the probability of physical property damage AND a possibility of serious injury.

WARNING: Procedures, which if not properly followed, create the probability of property damage, collateral damage, and serious injury OR create a high probability of superficial injury.

 **WARNING:** Read the ENTIRE instruction manual to become familiar with the features of the product before operating. Failure to operate the product correctly can result in damage to the product, personal property and cause serious injury.

This is a sophisticated hobby product. It must be operated with caution and common sense and requires some basic mechanical ability. Failure to operate this Product in a safe and responsible manner could result in injury or damage to the product or other property. This product is not intended for use by children without direct adult supervision. Do not attempt disassembly, use with incompatible components or augment product in any way without the approval of Horizon Hobby, Inc. This manual contains instructions for safety, operation and maintenance. It is essential to read and follow all the instructions and warnings in the manual, prior to assembly, setup or use, in order to operate correctly and avoid damage or serious injury.

Safety Precautions and Warnings

Age Recommendation: Not for children under 14 years. This is not a toy.

- Always keep a safe distance in all directions around your model to avoid collisions or injury. This model is controlled by a radio signal subject to interference from many sources outside your control. Interference can cause momentary loss of control.
- Always operate your model in open spaces away from full-size vehicles, traffic and people.
- Always carefully follow the directions and warnings for this and any optional support equipment (chargers, rechargeable battery packs, etc.).
- Always keep all chemicals, small parts and anything electrical out of the reach of children.
- Always avoid water exposure to all equipment not specifically designed and protected for this purpose. Moisture causes damage to electronics.
- Never place any portion of the model in your mouth as it could cause serious injury or even death.
- Never operate your model with low transmitter batteries.
- Always keep aircraft in sight and under control.
- Always move the throttle fully down at rotor strike.
- Always use fully charged batteries.
- Always keep transmitter powered on while aircraft is powered.
- Always remove batteries before disassembly
- Always keep moving parts clean.
- Always keep parts dry.
- Always let parts cool after use before touching.
- Always remove batteries after use.
- Never operate aircraft with damaged wiring.
- Never touch moving parts.

RTF | Ready-To-Fly
BLH2700

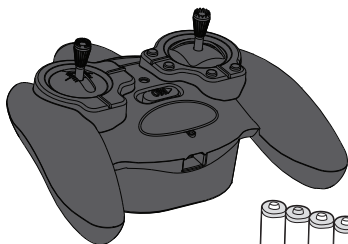

Box Contents

Scout CX Helicopter
70mAh 3.7V Li-Po Battery
Transmitter with Built-in Charger
Instruction Manual
AA Alkaline Batteries (4)



Advanced 2.4GHz Radio Control Lets Multiple Scout CX Helis Fly Together at the Same Time



Computerized Piezo Gyro for Superb Directional Control and Stability



Replacement Parts Available To Keep Your Scout CX Flying Like New



Proportional Rotor Head Servo for Smooth, Precise Control Response

Specifications

Length	160mm (6.30 in)
Height	105mm (4.15 in)
Rotor Diameter	130mm (5.10 in)
Gross Weight	17 g (0.60 oz)

Log on to www.bladescoutcx.com and follow the product registration link to stay connected.

Thank you for your purchase of the Blade® Scout CX™—a great Horizon Hobby RC product designed by experts to make your experience in RC as simple as possible. The Blade Scout CX comes out of the box completely assembled and flight tested. Even if you've never touched a Radio Control transmitter before, you're going to find the Scout is so stable and easy to fly that you'll feel like a pro after just a few minutes on the sticks. Thanks to 2.4GHz radio technology, you can fly several Scout helicopters with friends without worrying about radio interference.

Before you get started, though, you must read this manual. As easy as the Blade Scout CX is to fly, it's still a sophisticated Radio Controlled flying machine that has some features and pre-flight checks you'll need to be familiar with before you fly. The manual also has some handy flying tips you'll find especially helpful if you've never flown before.

Battery and Charger Warnings and Guidelines

The transmitter included with the Scout CX has been designed to safely charge the included Li-Po battery.

⚠ CAUTION: All instructions and warnings must be followed exactly. Mishandling of Li-Po batteries can result in a fire, personal injury, and/or property damage.

- By handling, charging or using the included Li-Po battery you assume all risks associated with lithium batteries.
- If at any time the battery begins to balloon or swell, discontinue use immediately. If charging or discharging, discontinue and disconnect. Continuing to use, charge or discharge a battery that is ballooning or swelling can result in fire.
- Always store the battery at room temperature in a dry area for best results.

- Always transport or temporarily store the battery in a temperature range of 40–120° F. Do not store battery or model in a car or direct sunlight. If stored in a hot car, the battery can be damaged or even catch fire.
- NEVER USE A Ni-Cd OR Ni-MH CHARGER. Failure to charge the battery with a compatible charger may cause fire resulting in personal injury and/or property damage.
- Never exceed the recommended charge rate.
- Never discharge Li-Po cells to below 3V under load.
- Never cover warning labels with hook and loop strips.

Charging

1. Power the transmitter off.
2. Insert the Li-Po battery into the charging jack on the bottom of the transmitter. Do not force the battery into the slot. The battery end cap only fits into the slot with the battery label facing up.
 - a. Charge LED solid = battery charging
 - b. Charge LED blinking = battery nearing full charge
 - c. Charge LED off = battery fully charged.
3. Remove the Li-Po battery from the transmitter when the battery is fully charged.

⚠ CAUTION: Do not store the Li-Po battery in the charger. Doing so could over-discharge the Li-Po battery.

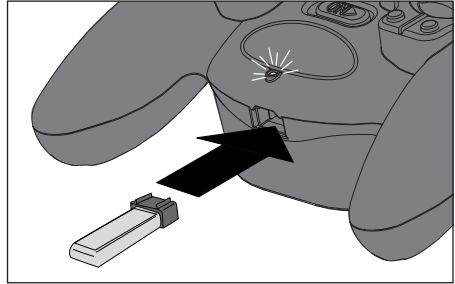

Replace transmitter batteries when the transmitter sounds an alarm (multiple beeps) while flying. Also, replace the batteries if flight battery charging takes longer than 30 minutes AND the charge LED remains solid.

Protecting your Flight Battery

The circuit board in the helicopter includes a protection circuit for your flight battery that ensures a proper discharge to within a safe limit for the battery. Once you realize that power is dropping off in flight, please land the helicopter.

The protection is activated when the Red LED on the circuit board starts flashing.

NOTICE: Flying the helicopter frequently with flashing Red LED will reduce the lifetime of your flight battery or even damage it.

Before Flying

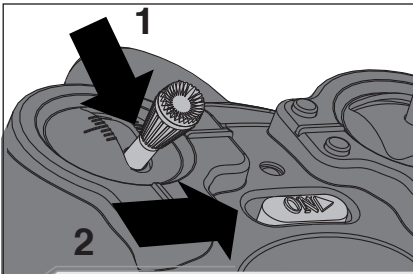

Lower the throttle to off, then power on the transmitter.

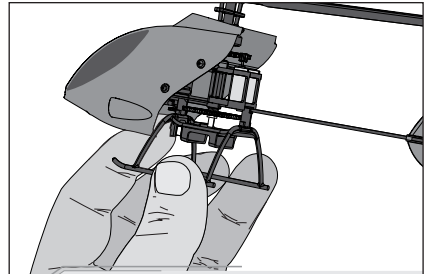

Hold the bottom of the Scout CX as shown to keep from damaging the circuit board.

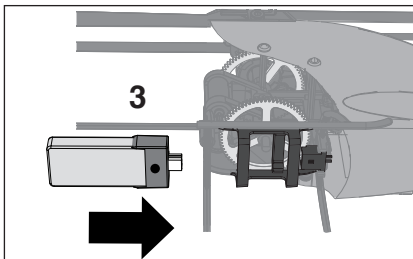

Insert and connect the Li-Po battery into the helicopter battery holder. Make sure to align the red dots on both the battery and the landing gear.

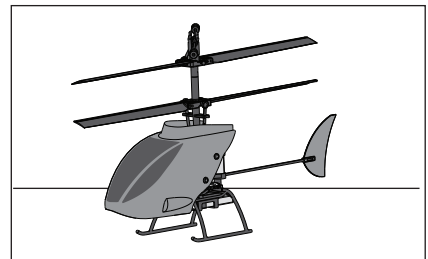

Put the helicopter on a flat, level surface. The helicopter gyro stabilizes at this time. Do not allow the helicopter to move until the red LED on the helicopter is solid.

CAUTION: The battery included with your Scout CX is keyed to only be inserted with the top of the battery facing up. Do not force it in with the opposite side facing up.

Transmitter Control

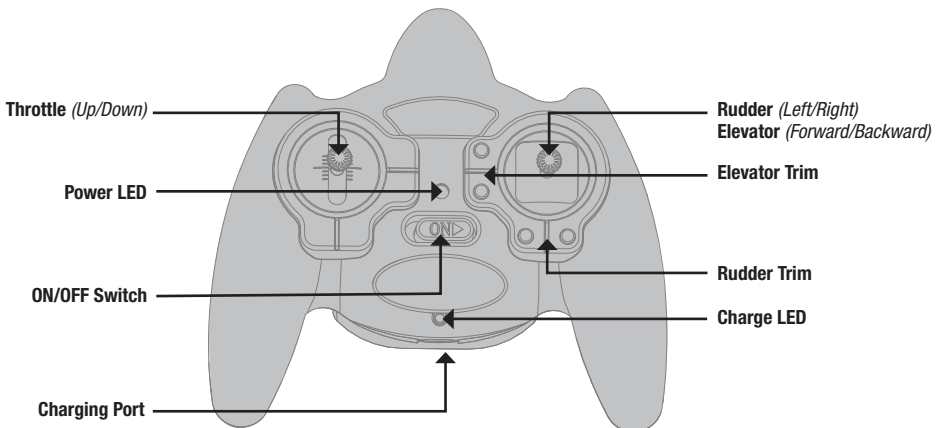

Flight Control

For smooth control of the Scout CX, always make small control movements. All directions are described as if you were sitting in the helicopter. For example -- when the helicopter nose is pointing toward you, left rudder (turn) will move the nose of the helicopter in the left direction (your right).

- **Flying up and down:** When your Scout CX is stable in the air, gently push/pull the throttle stick up/down to make it fly climb/descend.
- **Turning left and right:** When you are comfortable controlling the flying height of your Scout CX, try turning left/right by moving the rudder (steering stick) in the direction you want the helicopter to turn.
- **Flying forward and backward:** Gently move the elevator (steering stick) up and down to move the helicopter forward and backward.

Throttle

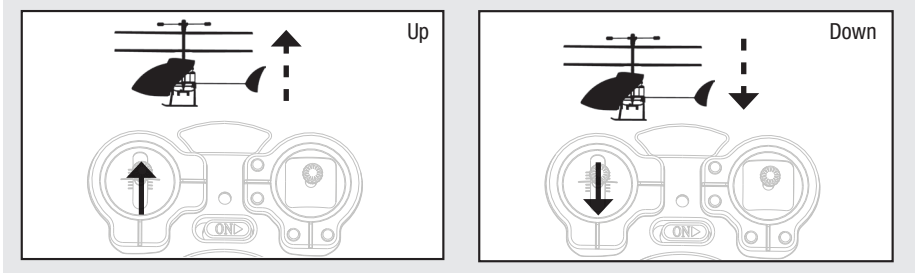

Elevator

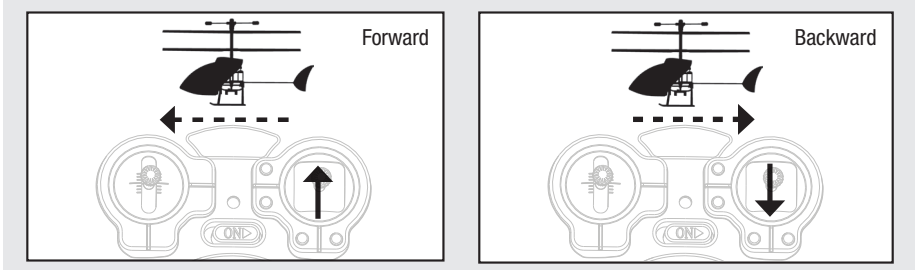

Rudder

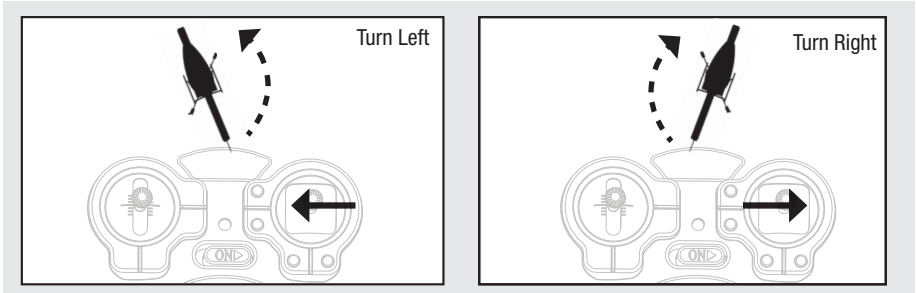

Lifting Off for the First Flight:

1. Pull the throttle stick down to the bottom of its travel and then turn ON the transmitter.
2. Place the Scout CX on the ground with the tail pointing toward you.
3. Gently move the throttle stick to 1/3 throttle. The rotor blades will spin and the Scout CX will climb. Climb to 1.0–1.5 meters (3–5 feet) high. Reduce and add throttle as needed to hover and descend.

Use smooth control stick movement when you are flying the helicopter. Always use small control stick movements and keep your fingers on the control sticks. If you notice that the Scout CX wants to wander/turn to the left or right, some steering adjustments may be necessary.

Making Flight Adjustments

Left or Right

The steering trim makes small adjustments to the helicopter's direction. If the nose (front) turns right, press the left trim button until the rotation stops and the nose stays in place. A long tone will be heard when the trim is at center.

If the heli turns left, then trim right.

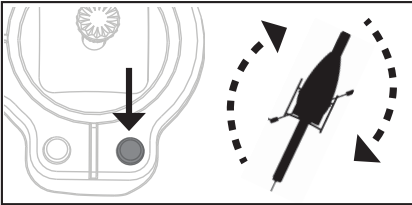

If the heli turns right, then trim left.

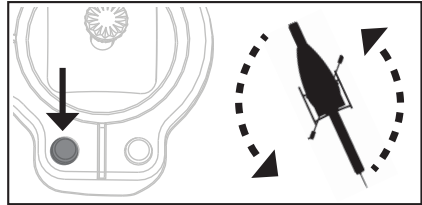

Forward or Backward

If the helicopter moves forward, press the elevator trim in the opposite direction the Scout CX is moving. A long tone will be heard when the trim is at center.

If the heli moves back, then trim forward.

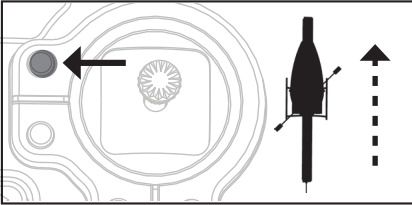

If the heli moves forward, then trim back.

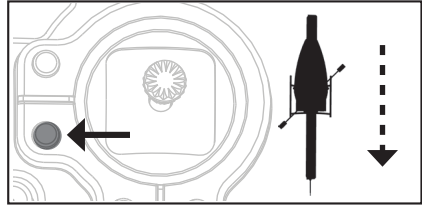

Flying in Circles

Move the right control stick toward the corners to fly in circles. The helicopter will move faster as the control stick reaches the corner.

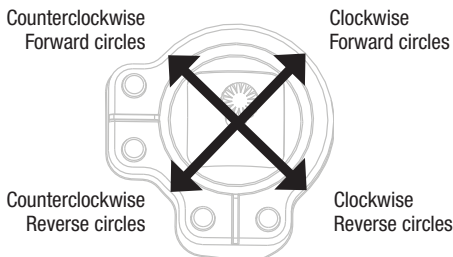

How to be a Successful Pilot

- Read the instruction manual carefully (especially the Troubleshooting section if you're having problems).
- Small, smooth control inputs are best. Quickly moving the stick just produces instability and no real flight control.
- Make sure the flight battery is fully charged before each flight. It's better to run the flight battery down to 50% or lower before recharging. A good, fully charged battery should be good for approximately 6 minutes of flight time. If your flight time falls below 4 minutes, your battery may need replaced.
- Keep the unit dry and clean. Carpet lint, pet hair, dirt, etc. can restrict the motor and controls, giving reduced power and control response times.
- Failure to Bind—Hold the Transmitter a few feet away from the helicopter while binding. Binding while too close can sometimes cause problems.
- Make sure that the tail boom is pushed fully into the frame. A loose tail will cause the helicopter to shake.
- Make sure the canopy is connected to all four mounting posts. A loose canopy will cause the helicopter to shake.
- The heli must be sitting perfectly still to initialize when you plug in the battery. If you are holding it in your hand or, moving it around, it may not initialize properly. There should be no reason to unplug it and start again. Just put it down on the landing skids and it will initialize in a few seconds.
- Make sure that the stabilizer/flybar is free to move up and down. This is what stabilizes the top rotor system. If the stabilizer/flybar is restricted, your Scout CX heli will not fly correctly.

After Flying

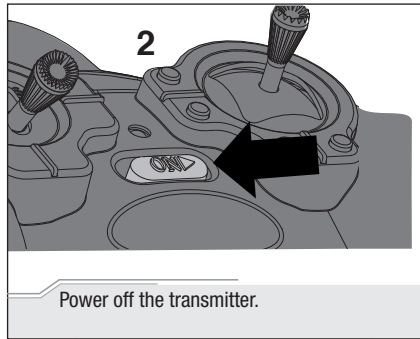
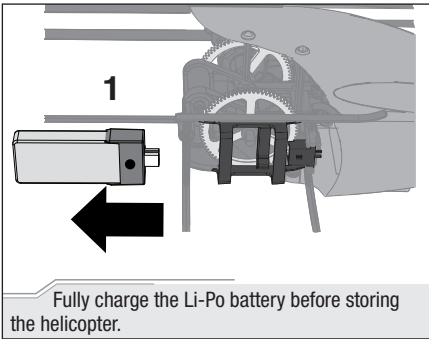

Transmitter and Receiver Binding

The Scout CX uses 2.4GHz radio frequency band and requires a “binding” procedure. Binding teaches the receiver the specific code of the transmitter, so it will only communicate to this transmitter. There should be no need to bind the transmitter and receiver prior to use. If you ever need to re-bind the transmitter and receiver, please follow the steps below.

✓ Binding Procedure:
1. Disconnect the flight battery from the helicopter.
2. Power off the transmitter.
3. Connect the flight battery in the helicopter. The onboard control unit LED flashes after 5 seconds.
4. Lower the throttle stick to its lowest position. Then, press in and hold the right stick while powering on the transmitter.
5. Release the right stick after 2–3 seconds. The helicopter is bound when both heli and transmitter LEDs are solid.
6. Disconnect the flight battery and power the transmitter off.

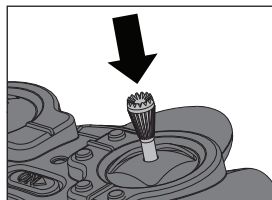

Troubleshooting Guide

Problem	Possible Cause	Solution
Helicopter throttle will not respond	Throttle at high position	Lower throttle stick to off for 3 seconds
Rotor blades will not turn	Low battery voltage	Completely recharge flight battery
Motor power decreases during flight	Receiver uses default soft Low Voltage Cutoff (LVC)	Recharge flight battery or replace battery that is no longer performing
Climb rate is greatly reduced	Low battery voltage	Recharge flight battery. Replace AA batteries in transmitter/charger. Replace flight battery if necessary
Helicopter vibrates or shakes in flight	Damaged rotor blades or flybar	Check main rotor blades and flybar for cracks or chips. Replace damaged parts
Helicopter climbouts are slow and/or nose turns while climbing/descending	Rotor drive gears are dirty, have hair in them, etc	Clean rotor gearing with a dry toothbrush and remove any dust or hair that may have accumulated

Exploded View and Parts Listing

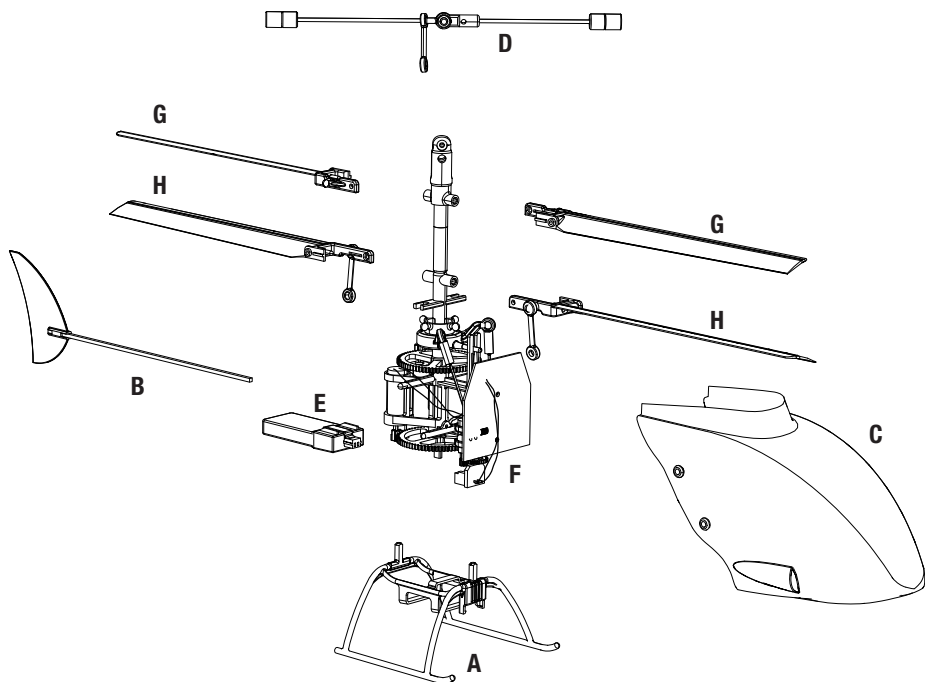

Part #	Description
A	BLH2722 Landing Skid and Battery Mount
B	BLH2723 Tail Boom and Fin Assembly
C	BLH2727 Canopy with Grommets
D	BLH2719 Stabilizer Flybar Set
E	EFLB0701S E-flite 3.7V 70mAh LiPo Battery

Part #	Description
F	BLH2724 Main frame flight module
G	BLH2721 Upper Main Blade Set (1 Pair)
H	BLH2720 Lower Main Blade Set (1 Pair)
	EFLR3240 Blade 3-Channel 2.4GHz Transmitter with Built-In Charger

Limited Warranty

What this Warranty Covers

Horizon Hobby, Inc. ("Horizon") warrants to the original purchaser that the product purchased (the "Product") will be free from defects in materials and workmanship at the date of purchase.

What is Not Covered

This warranty is not transferable and does not cover (i) cosmetic damage, (ii) damage due to acts of God, accident, misuse, abuse, negligence, commercial use, or due to improper use, installation, operation or maintenance, (iii) modification of or to any part of the Product, (iv) attempted service by anyone other than a Horizon Hobby authorized service center, or (v) Products not purchased from an authorized Horizon dealer.

OTHER THAN THE EXPRESS WARRANTY ABOVE, HORIZON MAKES NO OTHER WARRANTY OR REPRESENTATION, AND HEREBY DISCLAIMS ANY AND ALL IMPLIED WARRANTIES, INCLUDING, WITHOUT LIMITATION, THE IMPLIED WARRANTIES OF NON-INFRINGEMENT, MERCHANTABILITY AND FITNESS FOR A PARTICULAR PURPOSE. THE PURCHASER ACKNOWLEDGES THAT THEY ALONE HAVE DETERMINED THAT THE PRODUCT WILL SUITABLY MEET THE REQUIREMENTS OF THE PURCHASER'S INTENDED USE.

Purchaser's Remedy

Horizon's sole obligation and purchaser's sole and exclusive remedy shall be that Horizon will, at its option, either (i) service, or (ii) replace, any Product determined by Horizon to be defective. Horizon reserves the right to inspect any and all Product(s) involved in a warranty claim. Service or replacement decisions are at the sole discretion of Horizon. Proof of purchase is required for all warranty claims. SERVICE OR REPLACEMENT AS PROVIDED UNDER THIS WARRANTY IS THE PURCHASER'S SOLE AND EXCLUSIVE REMEDY.

Limitation of Liability

HORIZON SHALL NOT BE LIABLE FOR SPECIAL, INDIRECT, INCIDENTAL OR CONSEQUENTIAL DAMAGES, LOSS OF PROFITS OR PRODUCTION OR COMMERCIAL LOSS IN ANY WAY, REGARDLESS OF WHETHER SUCH CLAIM IS BASED IN CONTRACT, WARRANTY, TORT, NEGLIGENCE, STRICT LIABILITY OR ANY OTHER THEORY OF LIABILITY, EVEN IF HORIZON HAS BEEN ADVISED OF THE POSSIBILITY OF SUCH DAMAGES. Further, in no event shall the liability of Horizon exceed the individual price of the Product on which liability is asserted. As Horizon has no control over use, setup, final assembly, modification or misuse, no liability shall be assumed nor accepted for any resulting damage or injury. By the act of use, setup or assembly, the user accepts all resulting liability. If you as the purchaser or user are not prepared to accept the liability associated with the use of the Product, purchaser is advised to return the Product immediately in new and unused condition to the place of purchase.

Law

These terms are governed by Illinois law (without regard to conflict of law principals). This warranty gives you specific legal rights, and you may also have other rights which vary from state to state. Horizon reserves the right to change or modify this warranty at any time without notice.

WARRANTY SERVICES

Questions, Assistance, and Services

Your local hobby store and/or place of purchase cannot provide warranty support or service. Once assembly, set-up or use of the Product has been started, you must contact your local distributor or Horizon directly. This will enable Horizon to better answer your questions and service you in the event that you may need any assistance. For questions or assistance, please direct your email to productsupport@horizonhobby.com, or call 877.504.0233 toll free to speak to a Product Support representative. You may also find information on our website at www.horizonhobby.com.

Inspection or Services

If this Product needs to be inspected or serviced, please use the Horizon Online Service Request submission process found on our website or call Horizon to obtain a Return Merchandise Authorization (RMA) number. Pack the Product securely using a shipping carton. Please note that original boxes may be included, but are not designed to withstand the rigors of shipping without additional protection. Ship via a carrier that provides tracking and insurance for lost or damaged parcels, as Horizon is not responsible for merchandise until it arrives and is accepted at our facility. An Online Service Request is available at <http://www.horizonhobby.com> under the Support tab. If you do not have internet access, please contact Horizon Product Support to obtain a RMA number along with instructions for submitting your product for service. When calling Horizon, you will be asked to provide your complete name, street address, email address and phone number where you can be reached during business hours. When sending product into Horizon, please include your RMA number, a list of the included items, and a brief summary of the problem. A copy of your original sales receipt must be included for warranty consideration. Be sure your name, address, and RMA number are clearly written on the outside of the shipping carton.

NOTICE: Do not ship LiPo batteries to Horizon. If you have any issue with a LiPo battery, please contact the appropriate Horizon Product Support office.

Warranty Requirements

For Warranty consideration, you must include your original sales receipt verifying the proof-of-purchase date. Provided warranty conditions have been met, your Product will be serviced or replaced free of charge. Service or replacement decisions are at the sole discretion of Horizon.

Non-Warranty Service

Should your service not be covered by warranty service will be completed and payment will be required without notification or estimate of the expense unless the expense exceeds 50% of the retail purchase cost. By submitting the item for service you are agreeing to payment of the service without notification. Service estimates are available upon request. You must include this request with your item submitted for service. Non-warranty service estimates will be billed a minimum of ½ hour of labor. In addition you will be billed for return freight. Horizon accepts money orders and cashiers checks, as well as Visa, MasterCard, American Express, and Discover cards. By submitting any item to Horizon for service, you are agreeing to Horizon's Terms and Conditions found on our website <http://www.horizonhobby.com/Service/Request/>.

Warranty and Service Contact Information

Country of Purchase	Horizon Hobby	Address	Phone Number/Email Address
United States of America	Horizon Service Center (Electronics and engines)	4105 Fieldstone Rd Champaign, Illinois 61822 USA	877-504-0233 Online Repair Request: visit www.horizonhobby.com/service
	Horizon Product Support (All other products)	4105 Fieldstone Rd Champaign, Illinois 61822 USA	877-504-0233 productsupport@horizonhobby.com
United Kingdom	Horizon Hobby Limited	Units 1-4 Ployters Rd Staple Tye Harlow, Essex CM18 7NS United Kingdom	+44 (0) 1279 641 097 sales@horizonhobby.co.uk
Germany	Horizon Technischer Service	Hamburger Str. 10 25335 Elmshorn Germany	+49 4121 46199 66 service@horizonhobby.de
France	Horizon Hobby SAS	14 Rue Gustave Eiffel Zone d'Activité du Réveil Matin 91230 Montgeron	+33 (0) 1 60 47 44 70 infofrance@horizonhobby.com

Customer Service Information

Country of Purchase	Horizon Hobby	Address	Phone Number/Email Address
United States of America	Sales	4105 Fieldstone Rd Champaign, Illinois 61822 USA	(800) 338-4639 sales@horizonhobby.com
United Kingdom	Horizon Hobby Limited	Units 1-4 Ployters Rd Staple Tye Harlow, Essex CM18 7NS United Kingdom	+44 (0) 1279 641 097 sales@horizonhobby.co.uk
Germany	Horizon Hobby GmbH	Hamburger Str. 10 25335 Elmshorn Germany	+49 4121 46199 60 service@horizonhobby.de
France	Horizon Hobby SAS	14 Rue Gustave Eiffel Zone d'Activité du Réveil Matin 91230 Montgeron	+33 (0) 1 60 47 44 70 infofrance@horizonhobby.com

FCC Information

This device complies with part 15 of the FCC rules. Operation is subject to the following two conditions: (1) This device may not cause harmful interference, and (2) this device must accept any interference received, including interference that may cause undesired operation.

⚠ CAUTION: Changes or modifications not expressly approved by the party responsible for compliance could void the user's authority to operate the equipment.

This product contains a radio transmitter with wireless technology which has been tested and found to be compliant with the applicable regulations governing a radio transmitter in the 2.400GHz to 2.4835GHz frequency range.

Compliance Information for the European Union

Declaration of Conformity

(in accordance with ISO/IEC 17050-1)

No. HH2011062001



Product(s): Blade Scout CX RTF

Item Number(s): BLH2700

Equipment class: 1

The object of declaration described above is in conformity with the requirements of the specifications listed below, following the provisions of the European R&TTE directive 1999/5/EC and EMC Directive 2004/108/EC

EN 300-328 V1.7.1

EN 301 489-1 V1.7.1: 2006

EN 301 489-17 V1.3.2: 2008

EN 60950-1:2006+A11

EN55022: 2006,

EN55024: 1998+A1: 2001+A2: 2003

(EN61000-4-2: 2001, EN61000-4-3: 2006, EN61000-4-8: 2001)

Signed for and on behalf of:

Horizon Hobby, Inc.

Champaign, IL USA

June 20, 2011

Steven A. Hall

Vice President

International Operations and Risk Management

Horizon Hobby, Inc.

Instructions for disposal of WEEE by users in the European Union



This product must not be disposed of with other waste. Instead, it is the user's responsibility to dispose of their waste equipment by handing it over to a designated collection point for the recycling of waste electrical and electronic equipment. The separate collection and recycling of your waste equipment at the time of disposal will help to conserve natural resources and make sure that it is recycled in a manner that protects human health and the environment. For more information about where you can drop off your waste equipment for recycling, please contact your local city office, your household waste disposal service or where you purchased the product.

©2011 Horizon Hobby, Inc

Blade, E-flite and Scout CX are trademarks or registered trademarks of Horizon Hobby, Inc.

US patent number US D578,146. US 7,898,130. PRC ZL 200720069025.2 Other patents pending

Created 7/11 30946.I BLH2700