







Frame Assembly cont'd

Step F3 parts (bags F3 and F5)



-  Setscrew
M3 X 11 (x2)
-  Button head screw
M3 X 12 (x6)
-  Cap head bolt
M3 X 10 (x4)
-  Canopy
mounting post (x2)
-  M3 Washer (x6)
-  M3 Recessed
washer (x4)

• Slide the mainshaft into position, then tighten all the frame and servo screws.

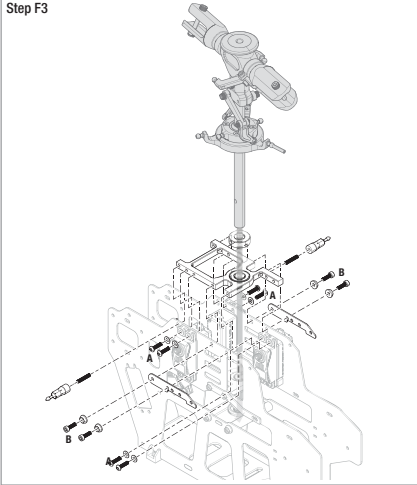
Step F3



Step F4 parts (bag F3)

-  Button head screw
M3 X 12 (x4)
-  M3 Recessed washer (x6)
-  Self tapping screw
M3 X 8 (x4)



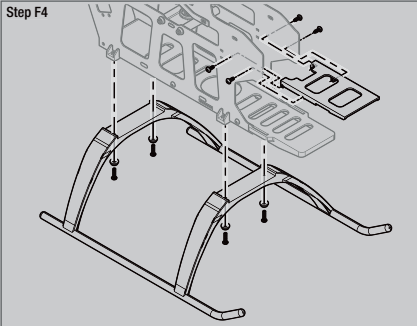

Step F4



EN

8

Step F4 parts (bag F4)

-  Button head screw
M3 X 12 (x4) 
-  M3 Recessed washer (x6)
-  Self tapping screw
M3 X 8 (x4) 

Step F4

