

Beechcraft Staggerwing 480 ARF

Assembly Manual



E-flite[®]
ADVANCING ELECTRIC FLIGHT

Notice

All instructions, warranties and other collateral documents are subject to change at the sole discretion of Horizon Hobby, Inc. For up-to-date product literature, visit <http://www.horizonhobby.com> and click on the support tab for this product.

Meaning of Special Language

The following terms are used throughout the product literature to indicate various levels of potential harm when operating this product:

NOTICE: Procedures, which if not properly followed, create a possibility of physical property damage AND a little or no possibility of injury.

CAUTION: Procedures, which if not properly followed, create the probability of physical property damage AND a possibility of serious injury.

WARNING: Procedures, which if not properly followed, create the probability of property damage, collateral damage, and serious injury OR create a high probability of superficial injury.



WARNING: Read the ENTIRE instruction manual to become familiar with the features of the product before operating. Failure to operate the product correctly can result in damage to the product, personal property and cause serious injury.

This is a sophisticated hobby product and NOT a toy. It must be operated with caution and common sense and requires some basic mechanical ability. Failure to operate this Product in a safe and responsible manner could result in injury or damage to the product or other property. This product is not intended for use by children without direct adult supervision. Do not attempt disassembly, use with incompatible components or augment product in any way without the approval of Horizon Hobby, Inc. This manual contains instructions for safety, operation and maintenance. It is essential to read and follow all the instructions and warnings in the manual, prior to assembly, setup or use, in order to operate correctly and avoid damage or serious injury.



Warnings

Read and follow all instructions and safety precautions before use. Improper use can result in fire, serious injury and damage to property.

Age Recommendation: Not for children under 14 years. This is not a toy.

COMPONENTS

Use only with compatible components. Should any compatibility questions exist, please refer to the product instructions, the component instructions or contact Horizon Hobby, Inc.

FLIGHT

Fly only in open areas to ensure safety. It is recommended flying be done at AMA (Academy of Model Aeronautics) approved flying sites. Consult local laws and ordinances before choosing a location to fly your aircraft.

PROPELLER

Keep loose items that can get entangled in the propeller away from the prop, including loose clothing, or other objects such as pencils and screwdrivers. Especially keep your hands away from the propeller as injury can occur.

BATTERIES

Notes on Lithium Polymer Batteries

When misused, lithium polymer batteries are significantly more volatile than alkaline or Ni-Cd/Ni-MH batteries used in RC applications. Always follow the manufacturer's instructions when using and disposing of any batteries. Mishandling of Li-Po batteries can result in fire causing serious injury and damage.

SMALL PARTS

This kit includes small parts and should not be left unattended near children as choking and serious injury could result.

SAFETY PRECAUTIONS

- Check all control surfaces prior to each takeoff.
- Do not fly your model near spectators, parking areas or any other area that could result in injury to people or damage of property.
- Do not fly during adverse weather conditions. Poor visibility or strong winds can cause disorientation and loss of control of your aircraft.
- Do not take chances. If at any time during flight you observe any erratic or abnormal operation, land immediately and do not resume flight until the cause of the problem has been ascertained and corrected. Safety can never be taken lightly.
- Do not fly near power lines.

Table of Contents

Notice	2
Meaning of Special Language	2
Warnings	2
Introduction	3
Important Information Regarding Warranty Information	3
Specifications	3
Using the Manual	3
Contents of Kit/Parts Layout	4
Hardware/Accessory Sizes	4
Recommended Radio Equipment.....	4
Park 480 Motor Setup.....	4
Optional Accessories	4
Optional Retracts	4
Required Tools and Adhesives	4
Binding the Radio System	4
Before Starting Assembly	5
Aileron Servo Installation	5
Flap Servo Installation.....	6
Fixed Landing Gear Installation	7
Retract Landing Gear Installation (Optional).....	9
Horizontal Stabilizer Installation	12
Rudder Preparation.....	13
Vertical Fin and Tail Wheel Installation.....	14
Elevator and Rudder Servo Installation	16
Motor and Speed Control Installation.....	18
Receiver and Motor Battery Installation	20
Retract Air Tank Installation (Optional)	20
Final Assembly	21
Center of Gravity	23
Control Throws	24
Preflight.....	25
Range Test Your Radio.....	25
Flying Your Model.....	25
Daily Flight Checks	26
Limited Warranty	26
Warranty Services	27
Academy of Model Aeronautics National Model Aircraft Safety Code	28
Building and Flying Notes	30-31

Introduction

The Beechcraft Staggerwing was the realization of Walter Beech's bold vision for an executive transport that could fly farther and faster than anything else at the time. That he realized his vision in 1932, in the midst of the Great Depression, is as remarkable as the revolutionary design born from it. With a speed of over 200 mph and range of over 800 miles, the Staggerwing eclipsed the performance of everything else in its class and was an instant success. Many Staggerwings still fly today, their graceful lines turning as many heads now as they did back then.

E-flite is pleased to bring you this exciting Staggerwing ARF that is sure to be as big a hit as its full-scale inspiration. Modeled after an aircraft used by the U.S. Navy as a V.I.P. transport, the E-flite Beechcraft Staggerwing 480 comes constructed of Z-Foam™ with carbon rod spars in the upper and lower wings. Most of its scale features, such as the detailed cockpit, clear windows, functioning flaps and authentic paint scheme, are already installed or applied.

Best of all, assembly is about as simple as it gets for an ARF with this level of detail. Only four sub-micro servos are required for all control surfaces and the horizontal stab comes in one piece for easy installation. The model even has a small chamber in the fuselage for housing an air tank should you want to add the optional pneumatic retracts.

Important Information Regarding Warranty Information

Please read our Warranty and Liability Limitations section before building this product. If you as the Purchaser or user are not prepared to accept the liability associated with the use of this Product, you are advised to return this Product immediately in new and unused condition to the place of purchase.

Specifications

Wingspan:	35.0 in (890mm)
Length:	30.7 in (780mm)
Wing Area:	354 sq in (22.9 sq dm)
Weight with battery:	22.0-25.7 oz (625-730 g)
Weight w/o battery:	28.6-32.3 oz (740-915 g)

Using the Manual

This manual is divided into sections to help make assembly easier to understand and to provide breaks between each major section. In addition, check boxes have been placed next to each step to keep track of its completion. Steps with a single circle (○) are performed once, while steps with two or more circles (○○) indicate the step will require repeating, such as for a right or left wing panel, two servos, etc.

Remember to take your time and follow the directions.

Contents of Kit/Parts Layout

Replacement Parts

EFL612501	Fuselage
EFL612502	Upper Wing
EFL612503	Lower Wing
EFL612504	Tail Set
EFL612505	Cowling
EFL612506	Canopy Hatch
EFL612507	Landing Gear Set
EFL612508	Spinner
EFL612509	Plastic Mounts
EFL612510	Interplane Struts
EFL612511	Scale Details
EFL612512	Pushrod Set



Hardware/Accessory Sizes

Wheel diameter	2-inch (52mm)
Wing bolts	3mm x 25mm machine screw

Recommended Radio Equipment

You will need a minimum 5-channel transmitter, receiver and four servos.

Recommended Complete Radio System

SPM6625 DX6i DSMX 6CH system

Or Purchase Separately

SPMAR6115 AR6115 6CH DSMX® Receiver
 EFLRDS76 DS76 Digital Sub-Micro Servo (4)
 EFLREX6L 6-inch (152mm) Lightweight Servo Extension (for ailerons)

Park 480 Motor Setup

EFLM1505 Park 480 1020Kv
 EFLA1040L 40-Amp Lite Pro Switch-Mode BEC Brushless ESC
 EFLB21003S 2100mAh 3S 14.8V 20C Li-Po, 12AWG EC3
 EFLP1080E 10 x 8 Propeller (included)
 EFLM1924L Prop Adapter with Collet Long, 4mm (optional)

Optional Accessories

EFLA110 Power Meter
 EFLC3020 Celectra 200W DC Multi-Chemistry Battery Charger
 EFLAEC312 Charge Lead with 12-inch Wire and Jacks, 16AWG

Optional Retracts

EFLGP0150 90 Degree Main Micro Pneumatic Retract Set
 EFLRDS76 DS76 Digital Sub-Micro Servo
 ROB164G 100 PSI Hand Air Pump with Gauge

Required Tools and Adhesives

Tools & Equipment

Felt-tipped pen Flat file
 Pencil Pin vise
 Pliers Ruler
 Sandpaper Side cutters
 Hobby scissors
 Drill bit: 1/16-inch (1.5mm)
 Hex wrench: 1.5mm, 3/32-inch
 Hobby knife with #11 blade
 Phillips screwdriver: #0, #1, #2

Optional Tools & Equipment

Balancing stand (optional)

Adhesives

Medium CA PAAPT02
 Thin CA PAAPT08
 Silicone adhesive PAAPT12
 Threadlock PAAPT42

Binding the Radio System

Before starting the assembly of your model, we recommend preparing your radio system for installation. This includes charging the transmitter and receiver batteries, as well as centering the trims and sticks on your transmitter. If using a computer radio, make sure to reset a model memory and name it for this particular model. We also recommend binding the transmitter and receiver at this time, following the instructions provided with your radio system.

→ We highly recommend re-binding the radio system once all the control throws are set. This will keep the servos from moving to their endpoints until the transmitter and receiver connect.

Before Starting Assembly

Before beginning the assembly of your model, remove each part from its bag for inspection. Closely inspect the fuselage, wing panels, rudder and stabilizer for damage. If you find any damaged or missing parts, contact the place of purchase.

E-tips

During the course of building your model, we suggest you use a soft base for the building surface. Such things as a foam stand, large piece of bedding foam or a thick bath towel will work well and help protect the model from damage during assembly. This is not shown in the instructions in order to provide the greatest detail in the photos.

E-tips

When referencing directions (up, down, left, right, top and bottom), these directions are in relationship to the pilot sitting in the cockpit of the aircraft, unless noted otherwise.

⚠ NOTICE: Do not use a CA accelerator during the assembly of your model. A CA accelerator will damage the finish of your model and can damage the foam as well. Even foam-safe accelerators will damage the finish of your model. Allow the CA to cure without the use of an accelerator.

Aileron Servo Installation

Required Parts

Top wing Transmitter
Receiver Receiver battery
40mm pushrod with clevis (2)
Servo with hardware

Required Tools and Adhesives

Phillips screwdriver: #0
Hobby knife with #11 blade

- 1. Use a hobby knife with a #11 blade to remove the material below the aileron servo tray. The servo lead will pass through this opening.

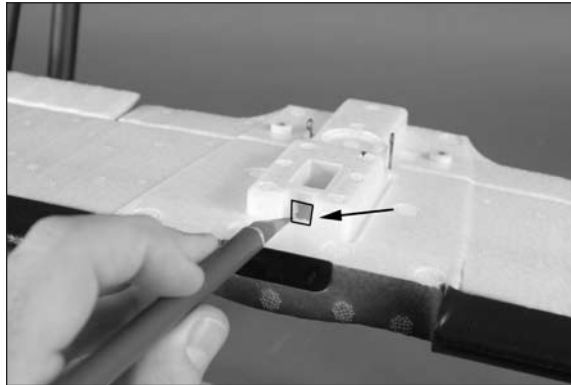

- 2. Install the aileron servo using the screws provided with the servo and a #0 Phillips screwdriver. Make sure the output shaft of the servo faces to the leading edge of the wing.



→ Due to the molding process, foam may cover one of the mounting holes in the plastic aileron mount. There are two screw holes; if one of them is obscured, you can locate it with something like a T-pin.

- 3. Use a #0 Phillips screwdriver to remove the stock servo horn from the servo. Center the aileron servo using the radio system. Install the two-sided horn so it is perpendicular to the servo centerline. Install the screw to secure the horn using a #0 Phillips screwdriver.



- 4. Insert the Z-bend of the 40mm pushrods in the outer holes of the servo horn as shown.



- 5. With the servo centered, adjust the length of the pushrod so the ailerons are centered as shown. Once set, slide the silicone tubing over the forks of the clevises to prevent them from opening in flight.

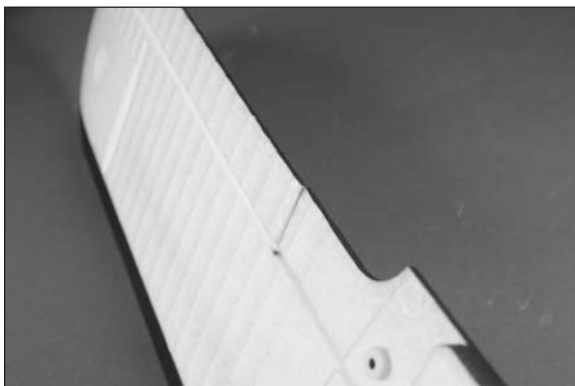

Flap Servo Installation

Required Parts

Bottom wing	Servo with hardware
Transmitter	Receiver
Receiver battery	25mm pushrod with clevis

Required Tools and Adhesives

Medium CA

- 1. Test fit the flap servo in the pocket in the bottom wing. The output shaft of the servo will face to the trailing edge of the wing.

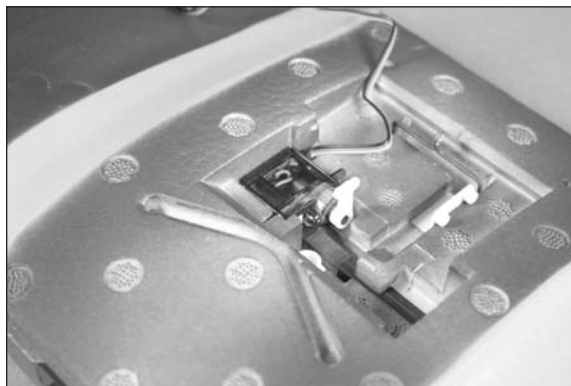

- 2. Use the radio system to set the flap servo to the UP flap position. Remove the stock servo horn using a #0 Phillips screwdriver and install the single-sided servo arm perpendicular to the servo center line as shown. Check that the servo moves the direction shown for DOWN flap.

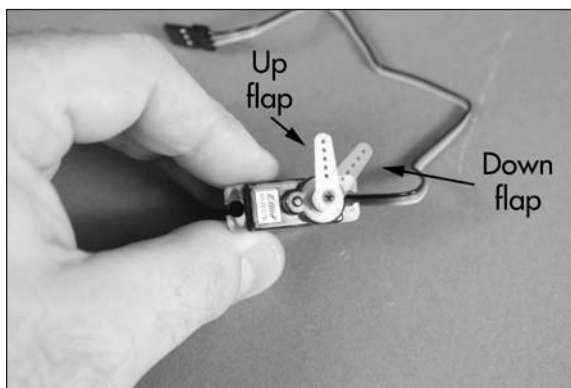

- 3. Use a small drop of medium CA to glue the flap servo to the exposed spar in the wing. Don't overglue the servo in case it requires removal in the future. Connect the flap linkage to the hole on the servo horn that is one away from the center of the horn as shown.

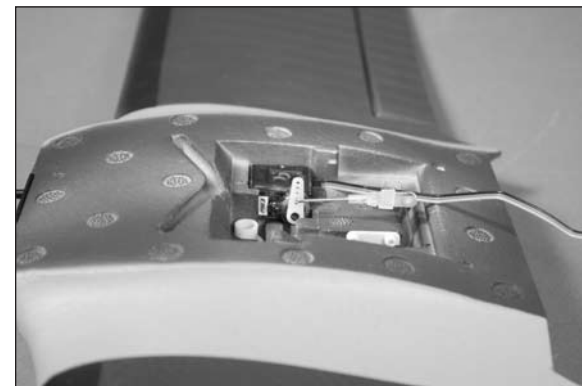

- 4. Adjust the linkage so the flaps are up when the servo is in the UP position. Slide the silicone tubing over the forks of the clevis once the flap linkage is adjusted.

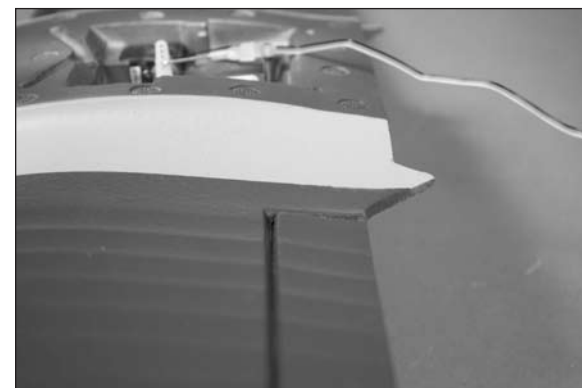

- 5. Check the position of the flaps for the MID-FLAP setting. It should match the throw listed in the back of the manual. Adjust this if necessary.

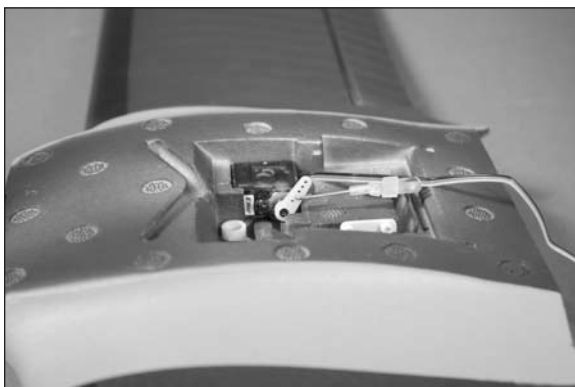

- 6. Check the position of the flaps for the DOWN setting. It should match the throw listed in the back of the manual. If not, adjust the end-point on the radio to match the throw listed for DOWN flap.

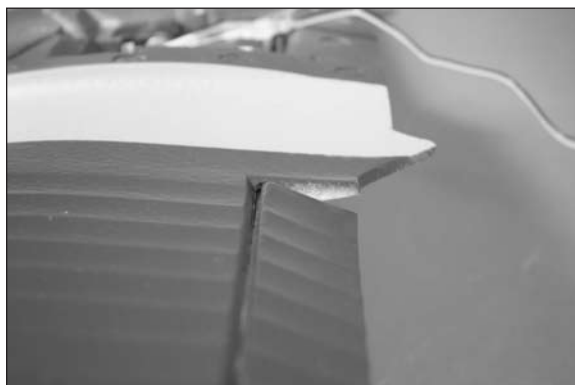

Fixed Landing Gear Installation

Required Parts

- Bottom wing
- Landing gear mount (2)
- Landing gear assembly (right and left)
- 2mm x 5mm self-tapping countersunk screw (8)
- Hex landing gear collet with setscrew (2)

Required Tools and Adhesives

- Flat file
- Felt-tipped pen
- Phillips screwdriver: #1
- Hex wrench: 1.5mm

Etips

The landing gear can be left off of your model, allowing you to hand-launch and belly-land the airplane. If you choose to do so, skip the landing gear installation and continue the assembly of your model at the Horizontal Stabilizer Installation section.

- 1. Locate the landing gear mount. Test fit the mount in the wing, aligning the holes in the mount with those in the wing. If the holes do not align, rotate the mount 90 degrees. Use a felt-tipped pen to make a small mark to indicate the front of the mount.





- 2. Use a flat file to remove any flashing from the landing gear wire so it will slide into the hex landing gear collet.

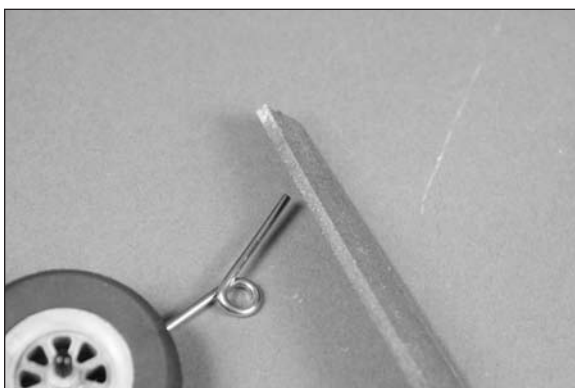

- 3. Check the landing gear assembly to make sure the correct assembly is placed on the correct side of the wing. The wheel faces to the center of the wing with the spring toward the trailing edge as shown.



Etips

Always use threadlock on metal-to-metal fasteners to prevent them from vibrating loose.

→ *Align wheels to centerline of the fuselage so that they neither angle in nor out. This will allow the airplane to track straight and will result in a much easier to handle airplane on the ground.*

- 4. Remove the landing gear assembly and mount from the wing. Slide the gear through the mount, then attach the hex landing gear collet on the wire. With the wire flush with the top of the collet, use a 1.5mm hex wrench to tighten the setscrew on the flat area of the wire.

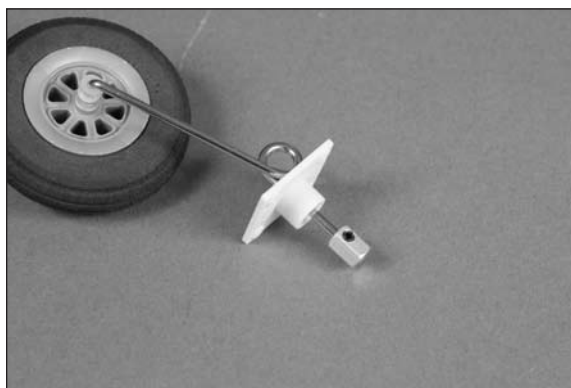

- 5. The hex collet can now be fitted into the mount. The collet will be exposed as shown. Make sure the wheel aligns with the mark made in step 1 on the mount.

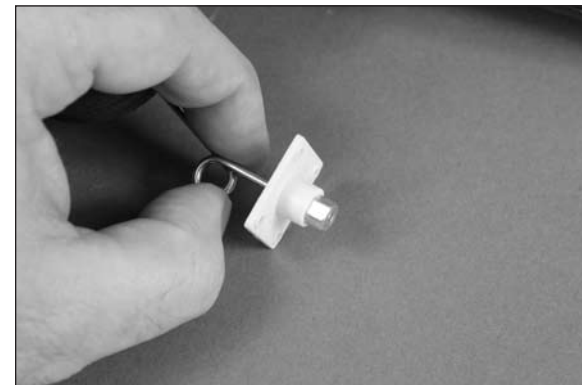

- 6. Use four 2mm x 5mm self-tapping countersunk screws to secure the mount in the wing as shown.

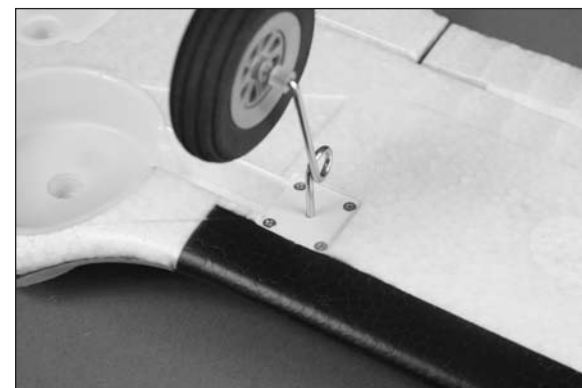

→ *Because of the molding process, the holes for the gear mount brackets may shift slightly. The screws will still thread into the brackets, however extra care must be taken to ensure that the screws do not cross thread or thread into another portion of the bracket.*

- 7. Repeat steps 1 through 6 to install the remaining landing gear and mount.

Retract Landing Gear Installation (Optional)

Required Parts

Bottom wing	Transmitter
Receiver	Receiver battery
Servo with hardware	
Retract set	
2-56 x 1/2-inch machine screw (2)	
Landing gear assembly (right and left)	
Landing gear door (right and left)	
2mm x 5mm self-tapping countersunk screw (8)	

Required Tools and Adhesives

Medium CA	Phillips screwdriver: #1
Pliers	Hobby knife with #11 blade
Ruler	Side cutters
Hobby scissors	Sandpaper
Hex wrench: 1.5mm	Silicone adhesive

E-tips

The landing gear can be left off of your model, allowing you to hand-launch and belly-land the airplane. If you choose to do so, skip the landing gear installation and continue the assembly of your model at the Horizontal Stabilizer Installation section.

- 1. Use a #0 Phillips screwdriver to remove the stock servo horn from the servo. Center the aileron servo using the radio system. Install the single-sided horn so it is perpendicular to the servo centerline. Install the screw to secure the horn using a #0 Phillips screwdriver

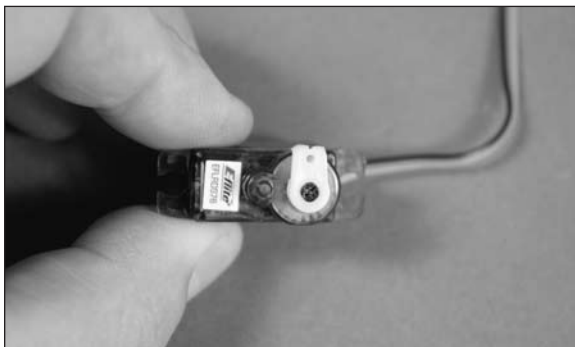

- 2. Use pliers to bend the pushrod included with the retracts so it measures 1 1/8-inch (28mm) in length. Use side cutters to trim the linkage so 1/4-inch (6mm) extends past the bend.

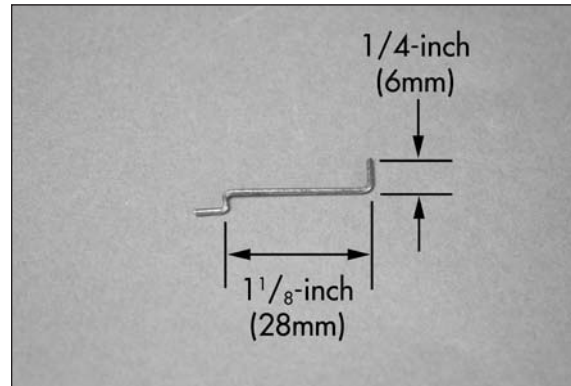

- 3. Insert the Z-bend in the servo horn. The retract servo is then installed in the wing with the output shaft oriented towards the leading edge as shown using a drop of medium CA. Don't over-glue the servo in case it requires removal in the future.

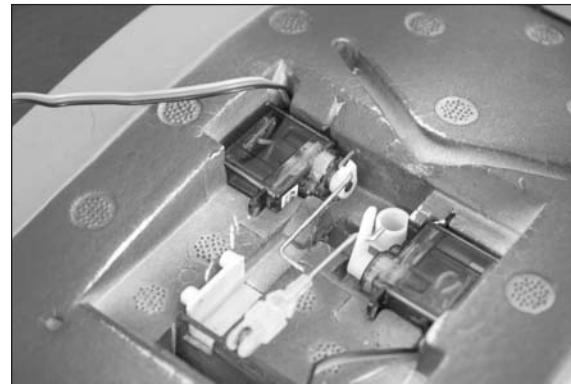

- 4. The nipples on the retract valve are offset slightly. Below, it is visible that the stopper end of the valve plunger orients TOWARDS the side where the nipple is the closest. Cut a 3-inch section of red airline and another of blue. These will be trimmed if required later. Connect the blue air line to the left nipple and the red airline to the right one as shown below.

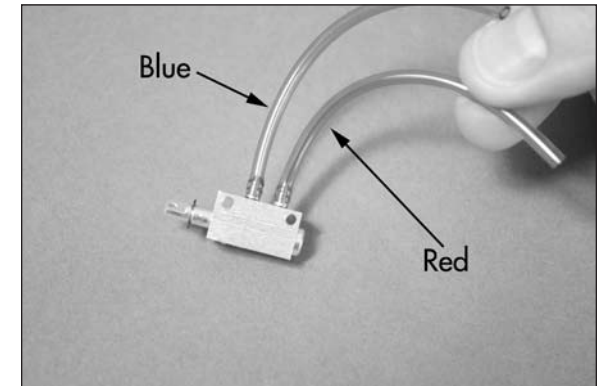

- 5. Insert the end of the linkage in the hole of the retract valve actuator. The valve is then secured in the wing using two 2-56 x 1/2-inch machine screws included with the retracts and a #1 Phillips screwdriver.

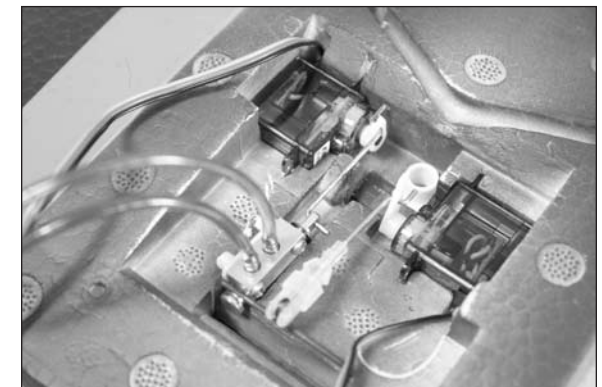

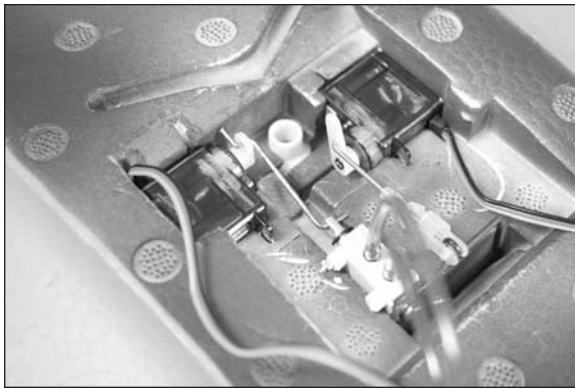

- 6. Use the radio system to set the throw necessary to actuate the retract valve. Work slowly, increasing the throw of the servo to avoid stalling the servo, which could damage the servo or retract valve.

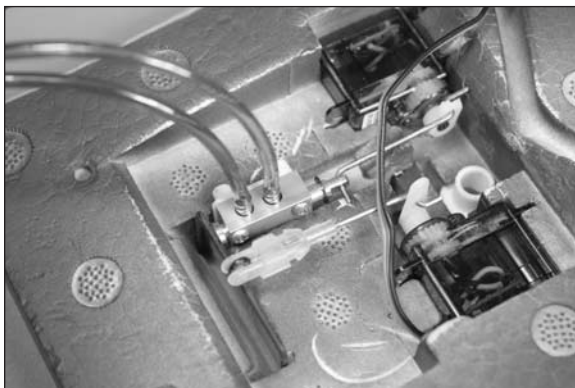
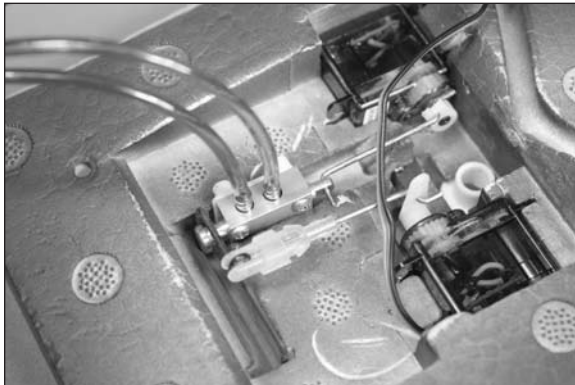

- 7. Use a hobby knife with a #11 blade to trim a 1½-inch (38mm) piece of red airline. Attach the air line to the retract fill valve. The fill valve is the longer valve of the two and has a brass nipple on the portion that will orient towards the inside of the wing. Do not confuse this valve with the quick-disconnect valve that is also included.

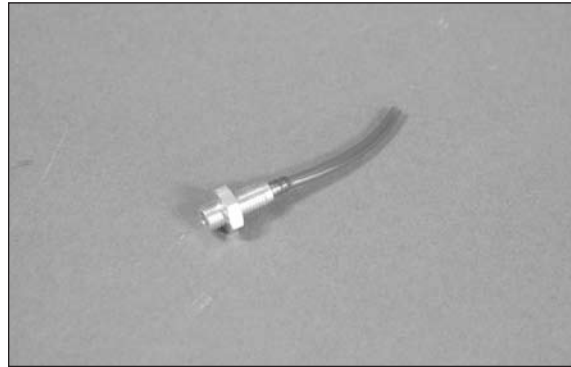

- 8. Press the fill valve into the wing from the bottom. The hex on the fill valve will key into the hex in the plastic. The top of the fill valve will be flush with the plastic on the inside of the wing. Connect a T fitting to the end of the red air line connected to the fill valve. Connect the red air line from the retract valve to the this T-fitting as well. This may need to be trimmed slightly.

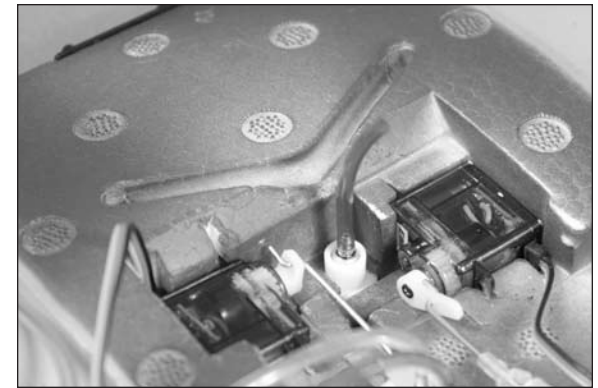

Etips

Always use threadlock on metal-to-metal fasteners to prevent them from vibrating loose.

- 9. Use a hobby knife with a #11 blade to trim a 2-inch (52mm) piece of red airline. Connect the airline to the quick disconnect valve. Connect the opposite end of the air line to a t-fitting.



- 10. Connect the t-fitting prepared in the previous step to the red air line of the retract valve, and to the air line from the retract fill valve.



- 11. Prepare the retracts for installation by securing the landing gear assembly into the retract mechanism using a 1.5mm hex wrench. Ensure that you make a left and a right gear leg as shown below.

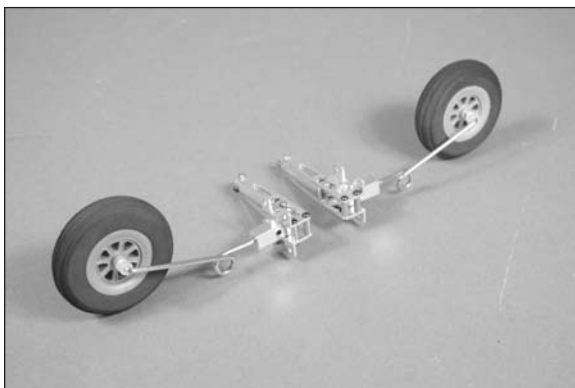

- 12. Cut two 6-inch sections of blue airline. Slide the air line through the hole in the wing, out to the location for the retract.

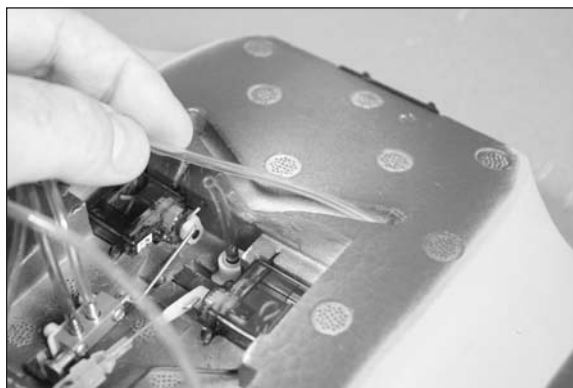

- 13. Connect the air line to the retract. Use a #1 Phillips screwdriver and four 2mm x 5mm self-tapping countersunk screws to secure the retract mechanism in the wing.

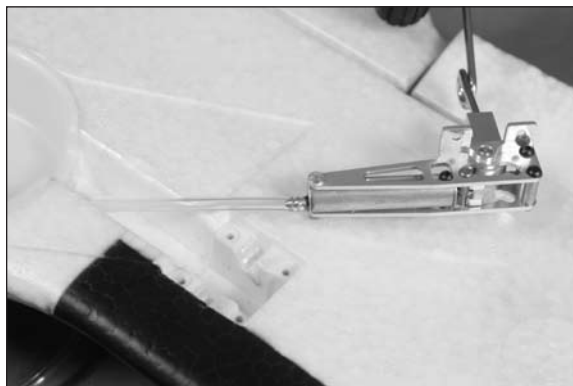

→ Because of the molding process, the holes for the gear mount brackets may shift slightly. The screws will still thread into the brackets, however extra care must be taken to ensure that the screws do not cross thread or thread into another portion of the bracket.

- 14. Trim the airline and connect it to the T-fitting. The airline should be long enough so the T-fitting rests in the center of the groove as shown. Connect the blue air line coming from the retract valve to the third nipple on this T-fitting. Trim if necessary so there is not too much excess.



- 15. Repeat steps 12 through 14 to install the remaining retract.

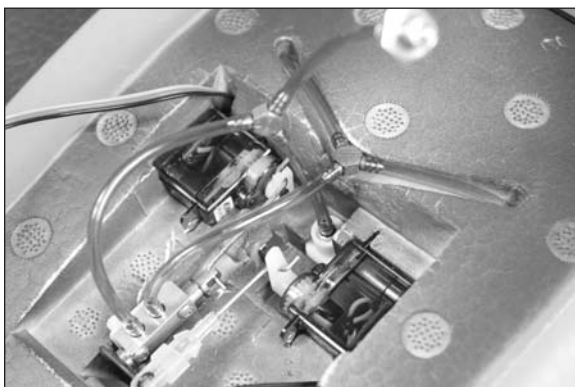

Horizontal Stabilizer Installation

Required Parts

Fuselage Top wing
 Stabilizer
 3mm x 25mm shoulder machine screw (2)

Required Tools and Adhesives

Medium CA Phillips screwdriver: #1

- 1. Fit the top wing into position on the fuselage, guiding the pins at the front of the wing into the fitting on the fuselage.

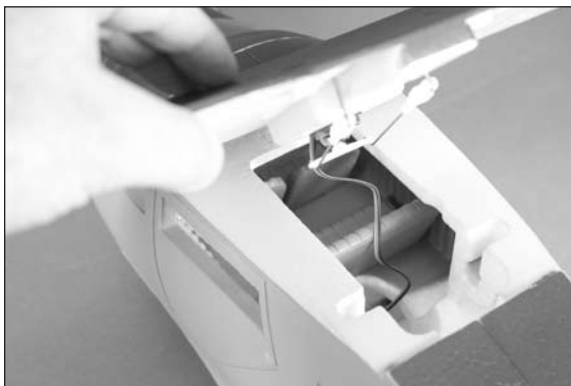

- 2. Use two 3mm x 25mm shoulder machine screws to attach the wing to the fuselage. Make sure the aileron lead is inside the fuselage.

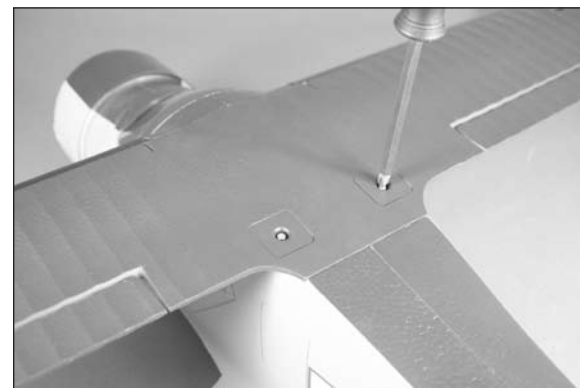

- 3. Place the stabilizer on the fuselage. Step back 8–10 feet (2–3 meters) and check that the stabilizer is aligned with the top wing as shown.

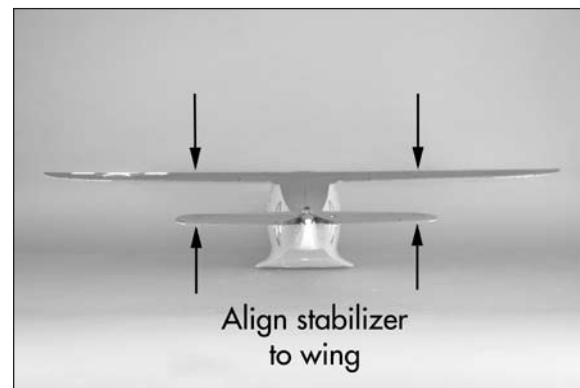

⚠ NOTICE: Do not use a CA accelerator during the assembly of your model. A CA accelerator will damage the finish of your model and can damage the foam as well. Even foam-safe accelerators will damage the finish of your model. Allow the CA to cure without the use of an accelerant.

Use caution with the amount of CA used. It should be enough to ensure a good bond, but not enough to ooze out as cleanup is more delicate with this airplane as opposed to a balsa airplane.

- 4. Apply a thin layer of medium CA to the fuselage and stabilizer where they meet. Make sure to apply CA to all the contact points so the stabilizer is glued securely to the fuselage.

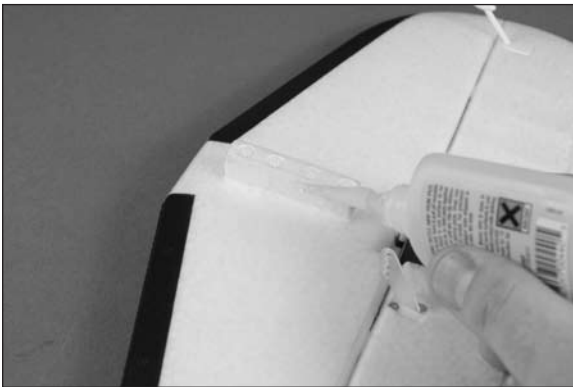
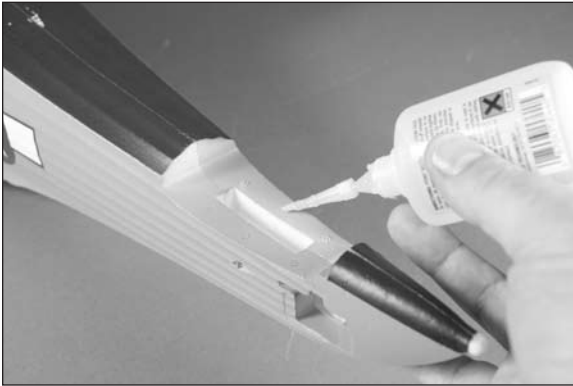

- 5. Place the stabilizer on the fuselage and check the alignment. Allow the CA to fully cure before proceeding. Sight the alignment again to ensure that the stabilizer does not shift. The use of medium CA allows for more working time to allow for rechecks and adjustments.

Rudder Preparation

Required Parts

Rudder with fin CA hinge (3)

Required Tools and Adhesives

Medium CA Hobby knife with #11 blade
Sandpaper

E-tips

If you are building your model for hand-launch and belly-landing, you may omit the use of the operational rudder and leave it fixed to the vertical fin. Skip to the next section of the manual to install the vertical fin.

- 1. Carefully cut the rudder from the fin using a hobby knife with a #11 blade. Cut the balance tab from the fin first, then cut along the hinge line.

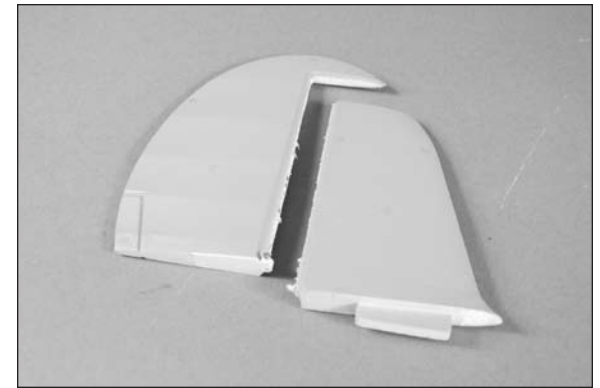
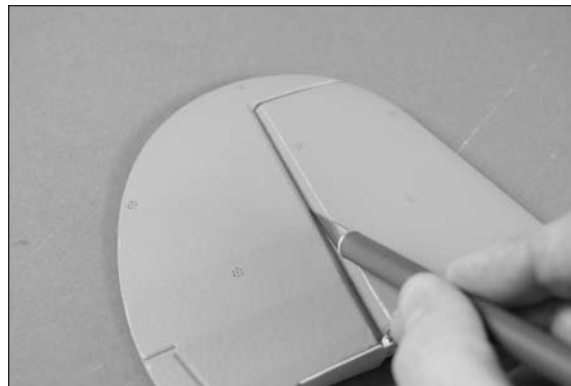

- 2. Use medium grit sandpaper to clean up the cuts on both the fin and rudder. Make sure to maintain the bevel along the hinge line.

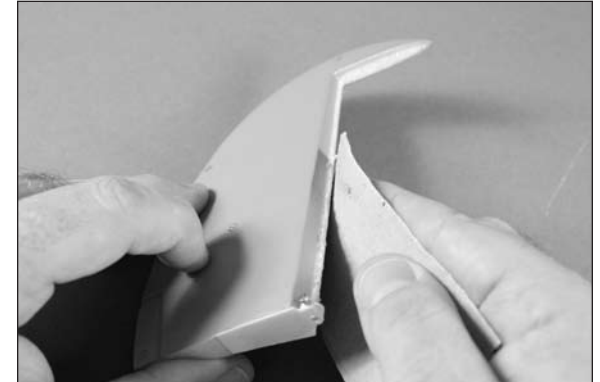

- 3. Cut three hinge slots in the rudder and fin as shown. The top and bottom hinges will be close to the top and bottom of the fin and rudder. Center the remaining hinge.



- 4. Use medium CA to glue the three CA hinges in the fin. Insert the hinge half-way into the fin, so the hinge will have equal portions in the fin and rudder. Allow the CA to cure before proceeding.

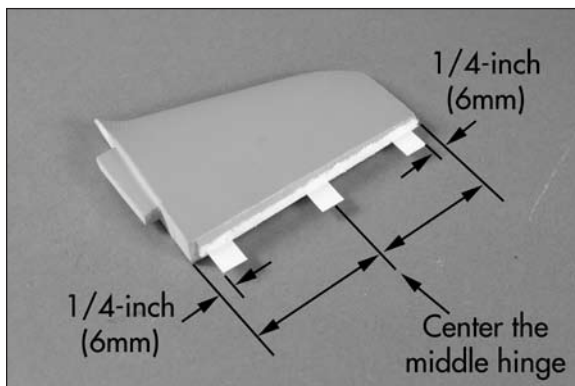

- ⚠ **NOTICE:** Do not use a CA accelerator during the assembly of your model. A CA accelerator will damage the finish of your model and can damage the foam as well. Even foam-safe accelerators will damage the finish of your model. Allow the CA to cure without the use of an accelerant.

- 5. Use medium CA to glue the hinges in the rudder. Once the CA has fully cured, check that the hinges are secure by gently pulling on the rudder and fin.

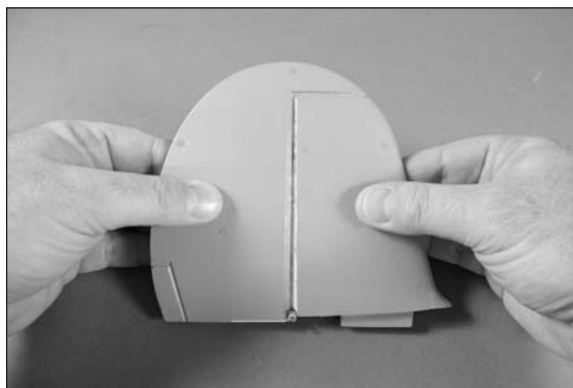

- 6. Break in the hinges by moving the rudder through its range of motion a number of times.



Vertical Fin and Tail Wheel Installation

Required Parts

Fuselage assembly with top wing
 Rudder and fin assembly
 Tail wheel assembly
 3mm nylon hex spacer
 Nylon steering arm
 Tail wheel bracket mount
 Tail wheel bracket mount cover
 Hex landing gear collet with setscrew
 1mm x 5mm self-tapping countersunk screw (4)

Required Tools and Adhesives

Hex wrench: 1.5mm Phillips screwdriver: #0
 Medium CA

- ⚠ **NOTICE:** Do not use a CA accelerator during the assembly of your model. A CA accelerator will damage the finish of your model and can damage the foam as well. Even foam-safe accelerators will damage the finish of your model. Allow the CA to cure without the use of an accelerant.

Use caution with the amount of CA used. It should be enough to ensure a good bond, but not enough to ooze out as cleanup is more delicate with this airplane as opposed to a balsa airplane.

E-tips

If you are building your model for hand-launch and belly-landing, the tail wheel will not be required. Perform steps 1, 8 and 9 if you are building your model for hand-launch and will not be installing the landing gear.

- 1. Place the rudder and fin assembly in the opening on the top of the stabilizer. Step back 8–10 feet (2–3 meters) and check that the rudder and fin are aligned perpendicular to the centerline of the top wing. Use medium CA to glue the vertical fin to the stabilizer. Make sure to apply CA to all contacting surfaces and to allow the CA to fully cure before proceeding. Sight the alignment again to ensure that the fin does not shift. The use of medium CA allows for more working time to allow for rechecks and adjustments.

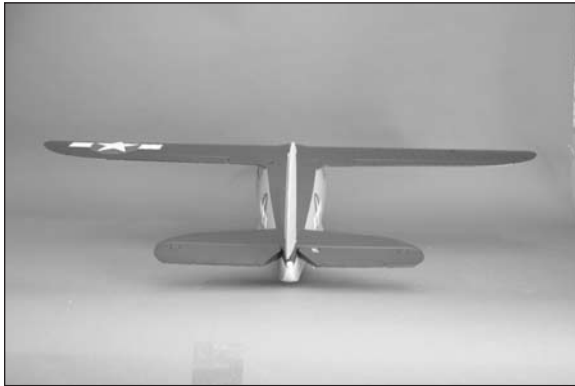

- 2. Slide the tail wheel assembly into the fuselage from the bottom.



- 3. Prepare the nylon steering arm by placing the hex landing gear collet on the hex of the steering arm. Note that the setscrew will face toward the top of the arm so the setscrew can easily be accessed.

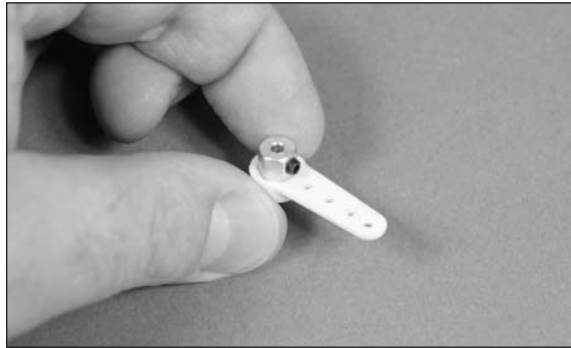

- 4. The 3mm nylon hex spacer is then slid onto the tail gear wire.

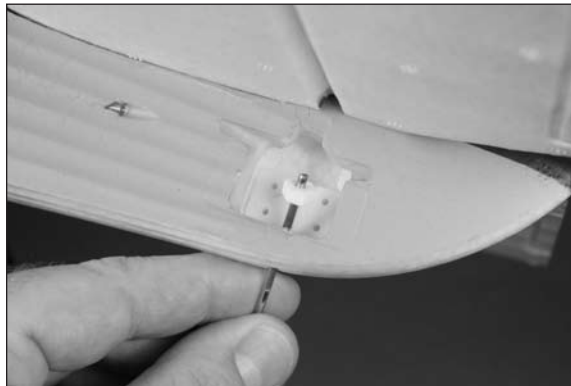

- 5. Slide the steering arm assembly onto the tail gear wire.

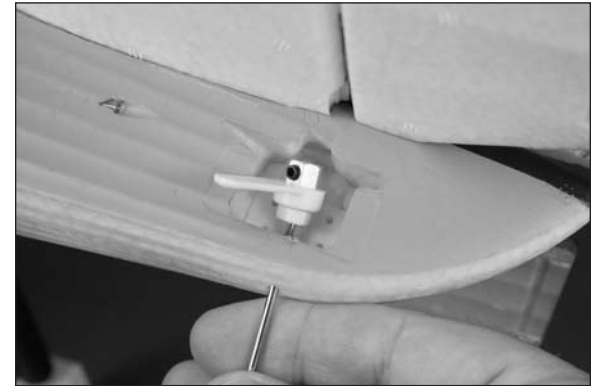

- 6. Insert the wire into the bracket on the bottom of the rudder. The 3mm hex spacer will key into the mount in the fuselage. Slide the steering arm down against the spacer and use a 1.5mm hex wrench to tighten the setscrew on the flat area of the tail gear wire. Install the tail wheel bracket mount using four 1mm x 5mm self-tapping countersunk screws and a #0 Phillips screwdriver.



Etips

Always use threadlock on metal-to-metal fasteners to prevent them from vibrating loose.

- 7. Use a #0 Phillips screwdriver to secure the tail gear wire in the mount located at the bottom of the rudder. Support the opposite side of the fin to ensure that it does not break when tightening the screw.



- 8. Use a drop of medium CA at the front and back of the tail wheel bracket mount cover to secure it to the fuselage. Don't over-glue the cover in case it requires removal to make changes to the steering arm or tail wheel assembly.

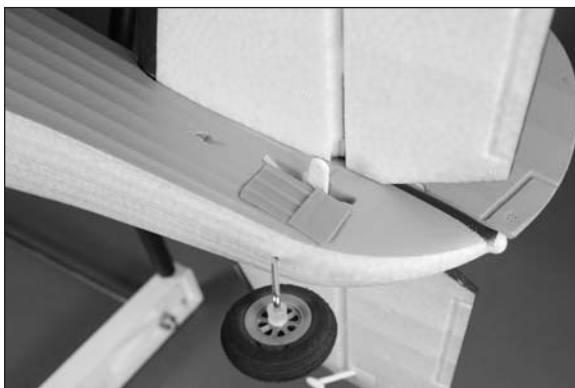

- 9. The top wing can now be removed from the fuselage to make the fuselage manageable for the install of the components in the fuselage.

Elevator and Rudder Servo Installation

Required Parts

Fuselage	Servo with hardware (2)
Transmitter	Receiver
Receiver battery	315mm pushrod with clevis (2)

Required Tools and Adhesives

Pencil	Thin CA
Pin vise	Drill bit: 1/16-inch (1.5mm)
Phillips screwdriver: #0	

- 1. Remove the servo cover by lifting it at the rear edge of the cover. The rear is held in position using magnets, and the front with a tab that keys into the fuselage. Set the cover aside.



- 2. Place the elevator servo in the servo tray toward the left side of the fuselage as shown, routing the servo lead under the tray. With the output of the servo facing to the front of the fuselage, use a pencil to mark the location for the servo mounting screws.



- 3. Remove the servo from the fuselage. Use a pin vise and 1/16-inch (1.5mm) drill bit to drill the two holes in the tray for the servo mounting screws.

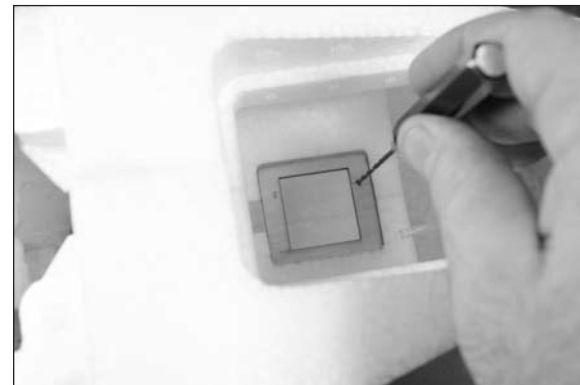

- ○ 4. Apply 2–3 drops of thin CA in each of the holes to harden the surrounding wood. This will harden the threads so the screws do not easily strip the surrounding wood.

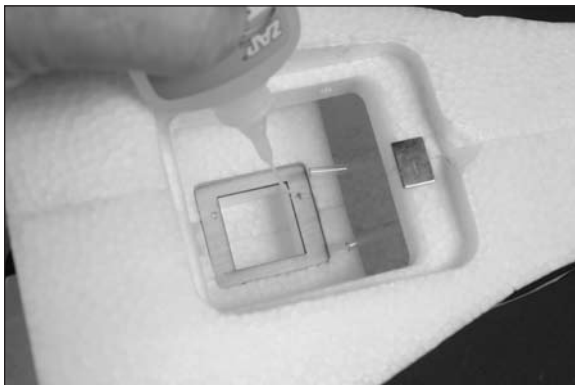

⚠ NOTICE: Do not use a CA accelerator during the assembly of your model. A CA accelerator will damage the finish of your model and can damage the foam as well. Even foam-safe accelerators will damage the finish of your model. Allow the CA to cure without the use of an accelerant.

- ○ 5. Mount the elevator servo in the fuselage using the screws provided with the servo and a #0 Phillips screwdriver.

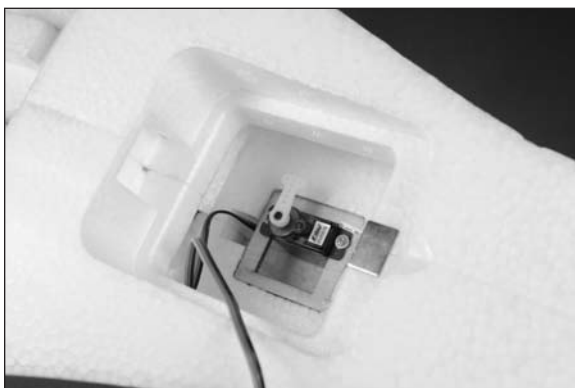

- ○ 6. Use a #0 Phillips screwdriver to remove the stock servo horn from the servo. Remove the clevis from the 315mm pushrod. Connect the Z-bend in the pushrod to the outer hole of a single-sided servo arm. Slide the pushrod into the pushrod tube. With the servo centered, attach the servo horn perpendicular to the servo centerline using the screw from the servo and a #0 Phillips screwdriver.

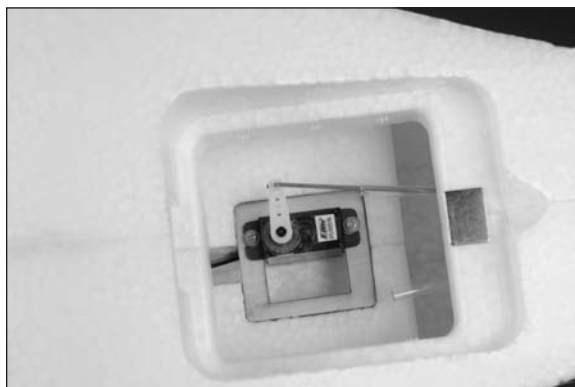

- ○ 7. Thread the clevis on the pushrod wire. Connect the clevis to the outer hole of the elevator control horn. With the servo centered, check that the elevator is centered. Thread the clevis in or out as necessary to center the elevator. Once centered, slide the silicone tube over the forks of the clevis to prevent the clevis from opening accidentally.



- 8. Repeat steps 2 through 8 to install the rudder servo and linkage.



Motor and Speed Control Installation

Required Parts

Fuselage assembly Motor with hardware
Hook and loop tape Propeller
Spinner assembly
Electronic speed control (ESC)
3mm x 8mm machine screw (4)
3mm x 20mm machine screw (2)

Required Tools and Adhesives

Threadlock Phillips screwdriver: #2
Hex wrench: 3/32-inch

- 1. Carefully remove the front windscreen cover from the fuselage. Rotate the bottom of the cover forward while removing it to prevent accidentally catching the front seats inside the fuselage.



- 2. Remove the cowl from the fuselage. It is held in position with a friction fit.



- 3. Pass the leads for the speed control through the upper hole in the fuselage and into the motor compartment as shown.



E-tips

Always use threadlock on metal-to-metal fasteners to prevent them from vibrating loose.

- 4. Use four 3mm x 8mm machine screws and a #2 Phillips screwdriver to attach the motor to the motor mount. Note that the wires on the motor will face to the top of the mount.

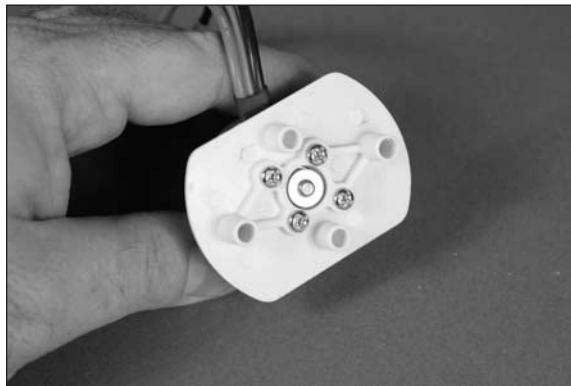

E-tips

Matching the colors between the ESC and motor when they are connected results in the correct motor direction if using all E-flite components.

- 5. Connect the leads from the motor to the leads of the ESC.

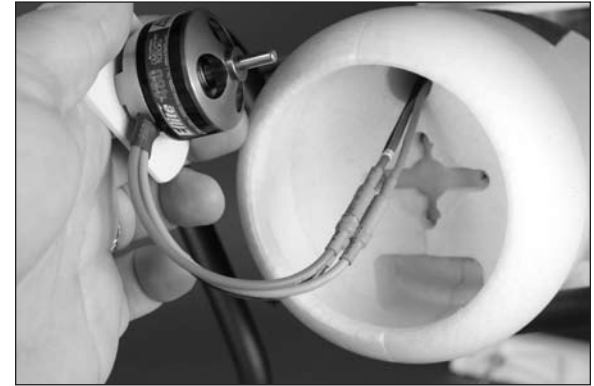

E-tips

Always use threadlock on metal-to-metal fasteners to prevent them from vibrating loose.

- 6. Guide the leads through the hole in the fuselage. Use two 3mm x 20mm machine screws and a #2 Phillips screwdriver to attach the motor mount to the fuselage.



- 7. If the cowl does not fit snugly on the fuselage, two-sided tape has been provided. Place the tape on the fuselage then install the cowl. This will keep the cowl secure on the fuselage.



- 8. Slide the cowl back on the fuselage, lining up the paint lines of the cowl with the paint lines on the fuselage.



Etips

Always balance your propeller. An unbalanced propeller can cause vibrations to be transmitted into the airframe, which could damage the airframe or other components as well as produce unwanted flight characteristics.

- 9. Assemble the propeller adapter, spinner backplate and propeller as shown. Note that the propeller is on the back side of the spinner backplate.

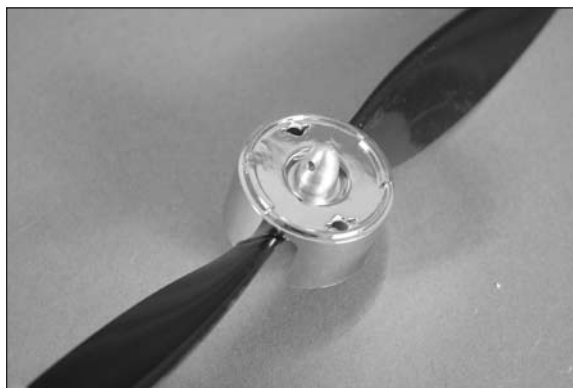

- 10. Slide the spinner assembly onto the motor shaft. Use a 3/32-inch hex wrench to tighten the adapter, securing the assembly to the motor shaft.



Etips

Make sure the propeller is centered in the openings so the spinner does not rub against the propeller blades, possibly causing them to fail.

- 11. Snap the spinner cone into position on the spinner backplate.



- 12. Use hook and loop tape to secure the speed control in the fuselage. Route the wires in the fuselage so they don't interfere with the operation of the motor or the installation of the motor battery.

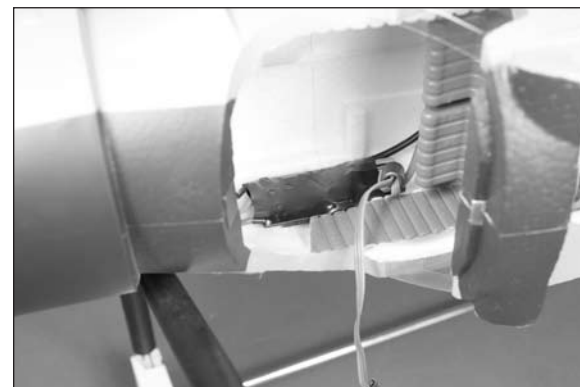

Receiver and Motor Battery Installation

Required Parts

Fuselage assembly Receiver
Motor battery Two-sided tape
Hook and loop tape (not included)
6-inch (152mm) servo extension

- 1. Route the 6-inch (152mm) servo extension from the top of the fuselage through to the battery compartment of the fuselage.



- 2. Place a piece of two-sided tape on the bottom of the receiver.

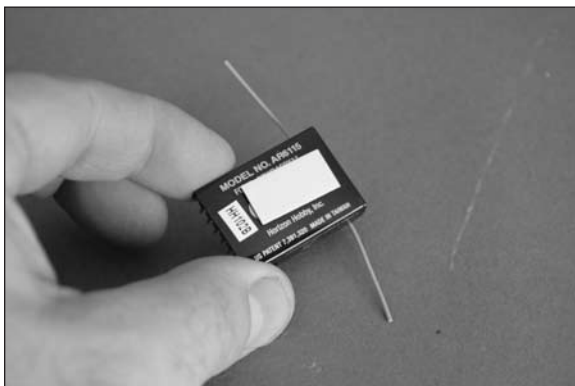

- 3. Connect the leads from the ESC, elevator servo, rudder servo, and the 6-inch (152mm) aileron servo extension to the appropriate ports of the receiver. Secure the receiver in the fuselage using the two-sided tape.

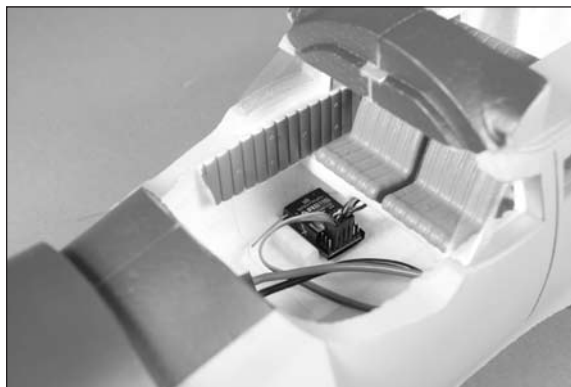

- 4. The motor battery will slide into the opening at the front of the fuselage. Use hook and loop tape on the battery and fuselage to keep it secure in the fuselage.



Retract Air Tank Installation (Optional)

Required Parts

Fuselage assembly Air tank
Air line Quick disconnect

Required Tools and Adhesives

Hobby knife with #11 blade
Silicone adhesive

- 1. Use a hobby knife with a #11 blade to trim a 2-inch (52mm) piece of red airline. Connect the airline to the air tank. Connect the quick disconnect to the opposite end of the air line.



- 2. Install the air tank in the fuselage. Use a very small amount of silicone adhesive to keep the air tank from moving in the fuselage. Don't over-glue the air tank in case it requires removal in the future.



Final Assembly

Required Parts

Fuselage assembly Top and bottom wing
 Antenna (2) Interplane strut (2)
 3mm x 25mm shoulder machine screw (4)
 2mm x 7mm self-tapping washer-head screw (4)

Required Tools and Adhesives

Medium CA Hobby knife with #11 blade
 Phillips screwdriver: #1

- 1. Locate the hole for the screw mount underneath the decal and use a hobby knife and #11 blade to remove the decal, exposing the location for the interplane strut screws.

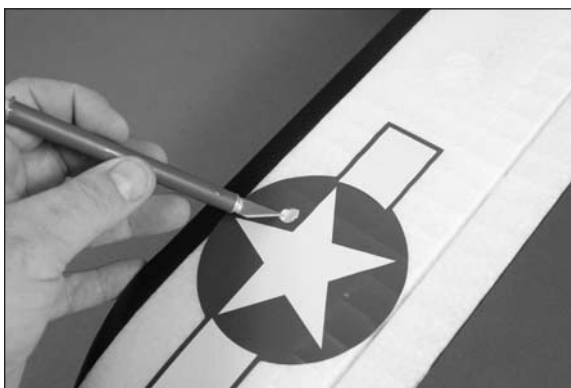

- 2. Position the bottom wing on the fuselage. Guide the flap servo lead (and retract servo lead) through to the receiver in the fuselage. Screw the quick disconnect valve together tightly. If it is not screwed together tightly, air will leak and the system will not hold pressure.

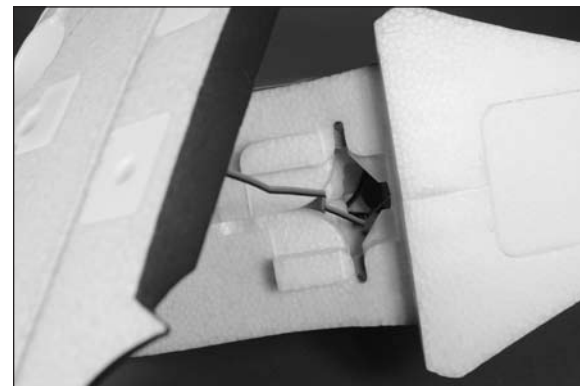

→ If you have installed retracts, make sure to connect the air lines from the wing and air tank, and the retract servo lead at this time as well.

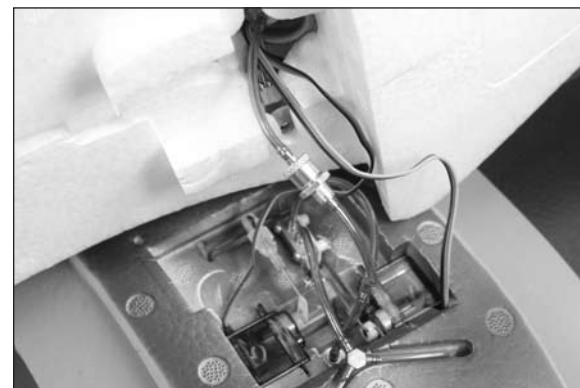

- 3. Check that the servo leads are inside the fuselage. Use two 3mm x 25mm shoulder machine screws and a #1 Phillips screwdriver to secure the bottom wing to the fuselage.



- 4. Replace the front windscreen cover on the fuselage, being careful not to contact the front seats in the fuselage.

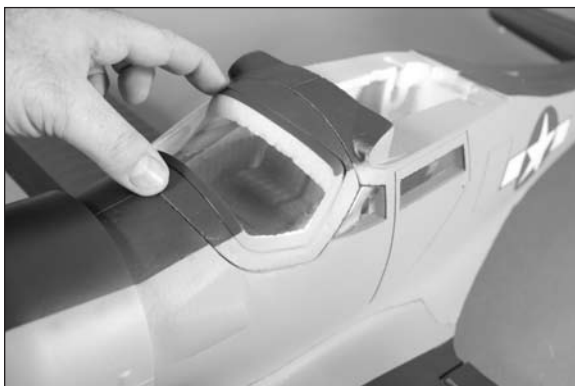

- 5. Place the narrow end of the interplane struts in the grooves in the top of the bottom wing. The struts will angle rearward as shown. Use a 2mm x 7mm self-tapping washer-head screw and a #1 Phillips screwdriver to secure the interplane strut to the bottom wing. Install both struts at this time.



- 6. Connect the lead for the aileron to the extension.



- 7. Position the top wing on the fuselage, making sure the interplane struts are positioned in the grooves on the bottom of the top wing. The top wing is secured to the fuselage using two 3mm x 25mm shoulder machine screws and a #1 Phillips screwdriver. Use a 2mm x 7mm self-tapping washer-head screw and a #1 Phillips screwdriver to secure the interplane strut to the wing.

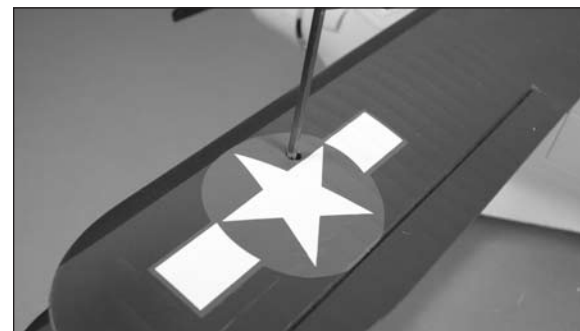

- 8. Use medium CA to glue the antenna to the top of the top wing as shown.



⚠ NOTICE: Do not use a CA accelerator during the assembly of your model. A CA accelerator will damage the finish of your model and can damage the foam as well. Even foam-safe accelerators will damage the finish of your model. Allow the CA to cure without the use of an accelerant.

Etips

Use care when handling the top wing after installing the antenna to prevent damage.

Etips

If you have assembled your model for hand-launch, **do not** cut the gear doors. Attach the gear doors as supplied to the underside of the wing with either silicone adhesive or tape.

- 9. Use hobby scissors to trim the lower section from the gear doors as shown. Use sandpaper to clean the cut line.

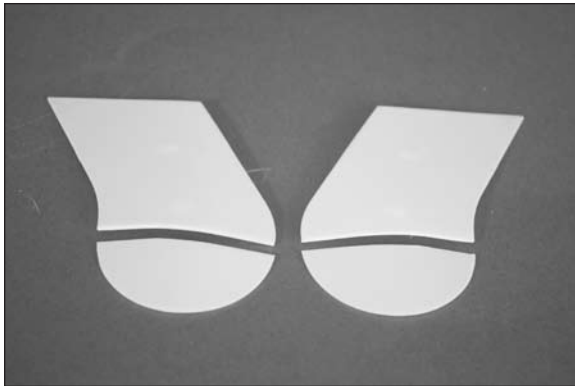

- 10. Attach the gear doors to the landing gear struts. Position the doors as close to the wing as possible. Use a drop of silicone adhesive to keep the doors from rotating.

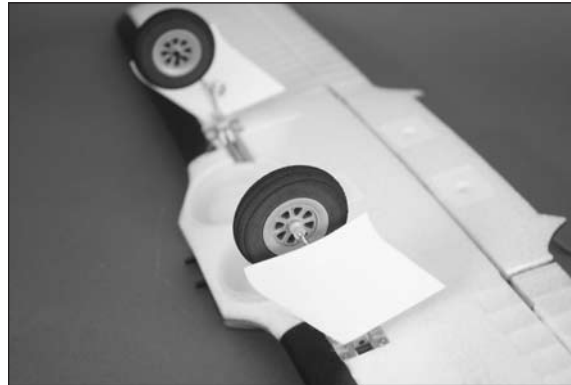

Center of Gravity

Required Parts

Assembled airframe

Required Tools and Adhesives

Felt-tipped pen Ruler

Phillips screwdriver: #2

Balancing stand (optional)

An important part of preparing the aircraft for flight is properly balancing the model.

⚠ CAUTION: Do not inadvertently skip this step or property damage and injury could occur.

- 1. Assemble your model in preparation for flight, making sure the wing is on securely and the motor battery is installed as instructed in this manual.
- 2. The recommended Center of Gravity (CG) location for your model is 2.25 to 2.50 inches (57 to 63mm) back from the leading edge of the bottom wing as shown with the battery pack installed. Mark the location of the CG on the top of the wing with a felt-tipped pen.

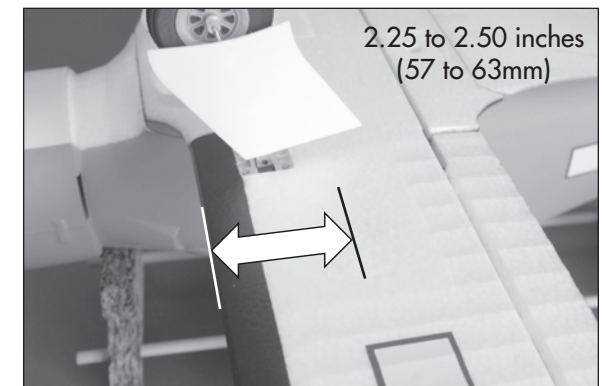

- 3. When balancing your model, support the plane upright at the marks made on the bottom of the lower wing with your fingers or a commercially available balancing stand. This is the correct balance point for your model. Make sure your model is assembled and ready for flight before balancing.

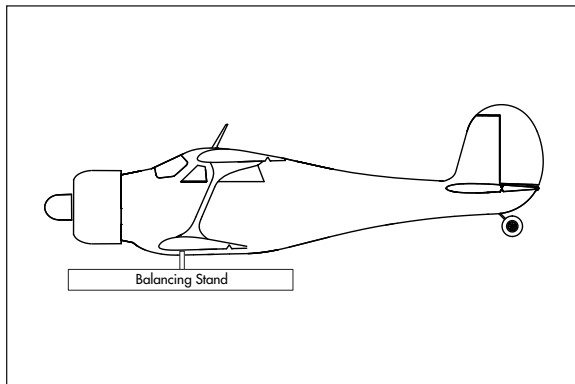

Adjust the motor battery as necessary so the model is level or slightly nose down. This is the correct balance point for your model. You should find the CG to be very close with the battery installed as shown in this manual. Mark the location of the battery on the battery tray using a felt-tipped pen so it can be returned to this position if it is removed from your model.

After the first flights, the CG position can be adjusted for your personal preference.

Control Throws

- 1. Turn on the transmitter and receiver of your model. Check the movement of the rudder using the transmitter. When the stick is moved right, the rudder should also move right. Reverse the direction of the servo at the transmitter if necessary.
- 2. Check the movement of the elevator with the radio system. Moving the elevator stick toward the bottom of the transmitter makes the airplane elevator move up.
- 3. Check the movement of the ailerons with the radio system. Moving the aileron stick right makes the right aileron move up and the left aileron move down.
- 4. Use a ruler to adjust the throw of the elevator, ailerons and rudder. Adjust the position of the pushrod at the control horn to achieve the following measurements when moving the sticks to their endpoints.

Aileron

High Rate			
Up:	1/2-inch	13mm	15% Expo
Down:	1/2-inch	13mm	15% Expo
Low Rate			
Up:	13/32-inch	10mm	15% Expo
Down:	13/32-inch	10mm	15% Expo

Elevator

High Rate			
Up:	21/32-inch	17mm	15% Expo
Down:	21/32-inch	17mm	15% Expo
Low Rate			
Up:	1/2-inch	13mm	15% Expo
Down:	1/2-inch	13mm	15% Expo

Rudder

High Rate			
Right:	3/4-inch	19mm	15% Expo
Left:	3/4-inch	19mm	15% Expo
Low Rate			
Right:	21/32-inch	17mm	15% Expo
Left:	21/32-inch	17mm	15% Expo

Flap

Mid	3/16-inch	5mm
Full	13/32-inch	10mm

→ We found it unnecessary to add any flap-to-elevator mixing during our testing of the Beechcraft Staggerwing.

E-tips

Measurements are taken at the inner or widest point on the control surface.

These are general guidelines measured from our own flight tests. You can experiment with higher rates to match your preferred style of flying.

E-tips

Travel Adjust and Sub-Trims are not listed and should be adjusted according to each individual model and preference.

E-tips

We highly recommend re-binding the radio system once all the control throws are set. This will keep the servos from moving to their endpoints until the transmitter and receiver connect.

Preflight

Check Your Radio

Before going to the field, be sure your batteries are fully charged per the instructions included with your radio. Charge the transmitter and motor battery for your airplane. Use the recommended charger supplied with your particular radio system, following the instructions provided with the radio. In most cases, the radio should be charged the night before going out flying.

Before each flying session, be sure to range check your radio. See your radio manual for the recommended range and instructions for your radio system. Each radio manufacturer specifies different procedures for their radio systems. Next, run the motor. With the model securely anchored, check the range again. The range test should not be significantly affected. If it is, do not attempt to fly! Have your radio equipment checked out by the manufacturer.

Double-check that all controls (aileron, elevator, rudder and throttle) move in the correct direction.

Check the radio installation and make sure all the control surfaces are moving correctly (i.e., the correct direction and with the recommended throws).

Check all the control horns, servo horns, and clevises to make sure they are secure and in good condition.

Range Test Your Radio

Before each flying session, and especially with a new model, it is important to perform a range check. It is helpful to have another person available to assist during the range check. If you are using a Spektrum™ transmitter, please refer to your transmitter's manual for detailed instructions on the range check process.

- 1. With the model resting on the ground, stand 30 paces (approximately 90 feet) away from the model.
- 2. Face the model with the transmitter in your normal flying position. Be sure the throttle is in the full down position and plug the flight battery into the speed control.
- 3. As you move the controls, watch to be sure the airplane's motor and controls operate smoothly. You should have total control of the model at 30 paces (90 feet).
- 4. If control issues exist, call the appropriate Horizon Product Support office (see page 43) or go to horizonhobby.com to find a local Spektrum distributor in your country for service if using a Spektrum radio system.

Flying Your Model

The E-flite Beechcraft Staggerwing is a mild-mannered biplane that tracks extremely well and is very appealing to a broad range of pilots. After verifying CG, ensuring the control throws and directions are correct, and verifying that the motor spins in the correct direction, all that's left to do is fly!

Confirm that a charged battery is installed, and, if the optional retracts are installed, ensure that the system has been charged. Taxi the airplane onto the runway and point the nose into the wind. Increase throttle trim until the propeller begins to windmill, however, the prop should not turn so fast as to cause the airplane to move when on a smooth surface. This is your flight idle. Smoothly advance the throttle and maintain directional control with the rudder to keep the airplane tracking straight down the runway. The airplane will lift off at a fairly low airspeed, so the takeoff run will be short.

Once in the air, trim the airplane so that it flies straight and level at around half throttle. If you are using the recommended Park 480 motor, you will find that it has sprightly performance. Flight above half throttle or so is simply unnecessary unless you are maneuvering. Even though the full-scale airplane would never be found flying aerobatics, you will find that the E-flite version has surprising aerobatic capability and handles basic aerobatics better than most. Before you are in the air too long, it is a good idea to slow the airplane down and see how it reacts on the slow end of the envelope. You'll find that the generous wing area of the Staggerwing will allow the airplane to fly at very low airspeeds, and with the use of flaps, it will fly even slower.

To land the airplane, enter the pattern parallel with the runway and reduce power. Once the airplane has slowed down, add a notch of flaps, and if your airplane is equipped with the micro pneumatic retracts, don't forget to extend your gear! Fly the airplane around and line up with the runway. When you're over the runway threshold, chop the power and fly it down. Once you get in ground effect, begin to flare and you'll find that the airplane will settle down nicely. Both wheel landings and full-stall landings are within the capabilities of this bird.

That's it, you've just successfully flown your new E-flite® Beechcraft Staggerwing 480! We wish you many enjoyable flights with it!

Daily Flight Checks

- 1. Check the battery voltage of the transmitter battery. Do not fly below the manufacturer's recommended voltage. Doing so can crash your aircraft.

E-tips

When you check the batteries, ensure that you have the polarities correct on your expanded scale voltmeter.

- 2. Check all hardware (linkages, screws, nuts, and bolts) prior to each day's flight. Be sure that binding does not occur and that all parts are properly secured.
- 3. Ensure all surfaces are moving in the proper manner.
- 4. Perform a ground range check before each day's flying session.
- 5. Prior to starting your aircraft, turn off your transmitter, then turn it back on. Do this each time you start your aircraft. If any critical switches are on without your knowledge, the transmitter alarm will sound a warning.
- 6. Check that all trim levers are in the proper location.
- 7. All servo pigtails and switch harness plugs should be secured in the receiver. Make sure the switch harness moves freely in both directions.

Limited Warranty

WHAT THIS WARRANTY COVERS

Horizon Hobby, Inc. ("Horizon") warrants to the original purchaser that the product purchased (the "Product") will be free from defects in materials and workmanship at the date of purchase.

WHAT IS NOT COVERED

This warranty is not transferable and does not cover (i) cosmetic damage, (ii) damage due to acts of God, accident, misuse, abuse, negligence, commercial use, or due to improper use, installation, operation or maintenance, (iii) modification of or to any part of the Product, (iv) attempted service by anyone other than a Horizon Hobby authorized service center, or (v) Products not purchased from an authorized Horizon dealer.

OTHER THAN THE EXPRESS WARRANTY ABOVE, HORIZON MAKES NO OTHER WARRANTY OR REPRESENTATION, AND HEREBY DISCLAIMS ANY AND ALL IMPLIED WARRANTIES, INCLUDING, WITHOUT LIMITATION, THE IMPLIED WARRANTIES OF NON-INFRINGEMENT, MERCHANTABILITY AND FITNESS FOR A PARTICULAR PURPOSE. THE PURCHASER ACKNOWLEDGES THAT THEY ALONE HAVE DETERMINED THAT THE PRODUCT WILL SUITABLY MEET THE REQUIREMENTS OF THE PURCHASER'S INTENDED USE.

PURCHASER'S REMEDY

Horizon's sole obligation and purchaser's sole and exclusive remedy shall be that Horizon will, at its option, either (i) service, or (ii) replace, any Product determined by Horizon to be defective. Horizon reserves the right to inspect any and all Product(s) involved in a warranty claim. Service or replacement decisions are at the sole discretion of Horizon. Proof of purchase is required for all warranty claims. SERVICE OR REPLACEMENT AS PROVIDED UNDER THIS WARRANTY IS THE PURCHASER'S SOLE AND EXCLUSIVE REMEDY.

LIMITATION OF LIABILITY

HORIZON SHALL NOT BE LIABLE FOR SPECIAL, INDIRECT, INCIDENTAL OR CONSEQUENTIAL DAMAGES, LOSS OF PROFITS OR PRODUCTION OR COMMERCIAL LOSS IN ANY WAY, REGARDLESS OF WHETHER SUCH CLAIM IS BASED IN CONTRACT, WARRANTY, TORT, NEGLIGENCE, STRICT LIABILITY OR ANY OTHER THEORY OF LIABILITY, EVEN IF HORIZON HAS BEEN ADVISED OF THE POSSIBILITY OF SUCH DAMAGES. Further, in no event shall the liability of Horizon exceed the individual price of the Product on which liability is asserted. As Horizon has no control over use, setup, final assembly, modification or misuse, no liability shall be assumed nor accepted for any resulting damage or injury. By the act of use, setup or assembly, the user accepts all resulting liability. If you as the purchaser or user are not prepared to accept the liability associated with the use of the Product, purchaser is advised to return the Product immediately in new and unused condition to the place of purchase.

LAW

These terms are governed by Illinois law (without regard to conflict of law principals). This warranty gives you specific legal rights, and you may also have other rights which vary from state to state. Horizon reserves the right to change or modify this warranty at any time without notice.

Warranty Services

QUESTIONS, ASSISTANCE, AND SERVICES

Your local hobby store and/or place of purchase cannot provide warranty support or service. Once assembly, setup or use of the Product has been started, you must contact Horizon directly. This will enable Horizon to better answer your questions and service you in the event that you may need any assistance. For questions or assistance, please direct your email to productsupport@horizonhobby.com, or call 877.504.0233 toll free to speak to a Product Support representative. You may also find information on our website at www.horizonhobby.com.

INSPECTION OR SERVICES

If this Product needs to be inspected or serviced, please use the Horizon Online Service Request submission process found on our website or call Horizon to obtain a Return Merchandise Authorization (RMA) number. Pack the Product securely using a shipping carton. Please note that original boxes may be included, but are not designed to withstand the rigors of shipping without additional protection. Ship via a carrier that provides tracking and insurance for lost or damaged parcels, as Horizon is not responsible for merchandise until it arrives and is accepted at our facility. An Online Service Request is available at <http://www.horizonhobby.com> under the Support tab. If you do not have internet access, please contact Horizon Product Support to obtain a RMA number along with instructions for submitting your product for service. When calling Horizon, you will be asked to provide your complete name, street address, email address and phone number where you can be reached during business hours. When sending product into Horizon, please include your RMA number, a list of the included items, and a brief summary of the problem. A copy of your original sales receipt must be included for warranty consideration. Be sure your name, address, and RMA number are clearly written on the outside of the shipping carton.

Notice: Do not ship LiPo batteries to Horizon. If you have any issue with a LiPo battery, please contact the appropriate Horizon Product Support office.

WARRANTY REQUIREMENTS

For Warranty consideration, you must include your original sales receipt verifying the proof-of-purchase date. Provided warranty conditions have been met, your Product will be serviced or replaced free of charge. Service or replacement decisions are at the sole discretion of Horizon.

NON-WARRANTY SERVICE

Should your service not be covered by warranty service will be completed and payment will be required without notification or estimate of the expense unless the expense exceeds 50% of the retail purchase cost. By submitting the item for service you are agreeing to payment of the service without notification. Service estimates are available upon request. You must include this request with your item submitted for service. Non-warranty service estimates will be billed a minimum of ½ hour of labor. In addition you will be billed for return freight. Horizon accepts money orders and cashiers checks, as well as Visa, MasterCard, American Express, and Discover cards. By submitting any item to Horizon for service, you are agreeing to Horizon's Terms and Conditions found on our website <http://www.horizonhobby.com/Service/Request/>.

UNITED STATES

(Electronics and engines)

Horizon Service Center
4105 Fieldstone Rd
Champaign, Illinois
61822 USA
productsupport@horizonhobby.com
877-504-0233
Online Repair Request visit:
www.horizonhobby.com/service

(All other products)

Horizon Product Support
4105 Fieldstone Rd
Champaign, Illinois
61822 USA
productsupport@horizonhobby.com
877-504-0233

UNITED KINGDOM

Horizon Hobby Limited
Units 1-4 Ployters Rd
Staple Tye
Harlow, Essex
CM18 7NS
United Kingdom
sales@horizonhobby.co.uk
+44 (0) 1279 641 097

GERMANY

Horizon Technischer Service
Hamburger Str. 10
25335 Elmshorn
Germany
service@horizonhobby.de
+49 4121 46199 66

FRANCE

Horizon Hobby SAS
14 Rue Gustave Eiffel
Zone d'Activité du Réveil Matin
91230 Montgeron
+33 (0) 1 60 47 44 70

Compliance Information for the European Union



INSTRUCTIONS FOR DISPOSAL OF WEEE BY USERS IN THE EUROPEAN UNION

This product must not be disposed of with other waste. Instead, it is the user's responsibility to dispose of their waste equipment by handing it over to a designated collection point for the recycling of waste electrical and electronic equipment. The separate collection and recycling of your waste equipment at the time of disposal will help to conserve natural resources and ensure that it is recycled in a manner that protects human health and the environment. For more information about where you can drop off your waste equipment for recycling, please contact your local city office, your household waste disposal service or where you purchased the product.

Academy of Model Aeronautics National Model Aircraft Safety Code

Effective January 1, 2011

A. GENERAL

A model aircraft is a non-human-carrying aircraft capable of sustained flight in the atmosphere. It may not exceed limitations of this code and is intended exclusively for sport, recreation and/or competition. All model flights must be conducted in accordance with this safety code and any additional rules specific to the flying site.

1. Model aircraft will not be flown:
 - (a) In a careless or reckless manner.
 - (b) At a location where model aircraft activities are prohibited.
2. Model aircraft pilots will:
 - (a) Yield the right of way to all man carrying aircraft.
 - (b) See and avoid all aircraft and a spotter must be used when appropriate. (AMA Document #540-D-See and Avoid Guidance.)
 - (c) Not fly higher than approximately 400 feet above ground level within three (3) miles of an airport, without notifying the airport operator.
 - (d) Not interfere with operations and traffic patterns at any airport, heliport or seaplane base except where there is a mixed use agreement.
 - (e) Not exceed a takeoff weight, including fuel, of 55 pounds unless in compliance with the AMA Large Model Aircraft program. (AMA Document 520-A)
 - (f) Ensure the aircraft is identified with the name and address or AMA number of the owner on the inside or affixed to the outside of the model aircraft. (This does not apply to model aircraft flown indoors).
 - (g) Not operate aircraft with metal-blade propellers or with gaseous boosts except for helicopters operated under the provisions of AMA Document #555.
 - (h) Not operate model aircraft while under the influence of alcohol or while using any drug which could adversely affect the pilot's ability to safely control the model.

(i) Not operate model aircraft carrying pyrotechnic devices which explode or burn, or any device which propels a projectile or drops any object that creates a hazard to persons or property.

Exceptions:

- Free Flight fuses or devices that burn producing smoke and are securely attached to the model aircraft during flight.
- Rocket motors (using solid propellant) up to a G-series size may be used provided they remain attached to the model during flight. Model rockets may be flown in accordance with the National Model Rocketry Safety Code but may not be launched from model aircraft.
- Officially designated AMA Air Show Teams (AST) are authorized to use devices and practices as defined within the Team AMA Program Document (AMA Document #718).
 - (i) Not operate a turbine-powered aircraft, unless in compliance with the AMA turbine regulations. (AMA Document #510-A).
- 3. Model aircraft will not be flown in AMA sanctioned events, air shows or model demonstrations unless:
 - (a) The aircraft, control system and pilot skills have successfully demonstrated all maneuvers intended or anticipated prior to the specific event.
 - (b) An inexperienced pilot is assisted by an experienced pilot.
- 4. When and where required by rule, helmets must be properly worn and fastened. They must be OSHA, DOT, ANSI, SNELL or NOCSAE approved or comply with comparable standards.

B. RADIO CONTROL (RC)

1. All pilots shall avoid flying directly over unprotected people, vessels, vehicles or structures and shall avoid endangerment of life and property of others.
2. A successful radio equipment ground-range check in accordance with manufacturer's recommendations will be completed before the first flight of a new or repaired model aircraft.



© 2011 Horizon Hobby, Inc.
horizonhobby.com
www.e-fliterc.com

E-flite, DSM2, DSMX and the Horizon Hobby logo are trademarks or registered trademarks of Horizon Hobby, Inc.
The Spektrum trademark is used with permission of Bachmann Industries, Inc.
All other trademarks, service marks and logos are the property of their respective owners.