

# 3.1m SU-26MM Sukhoi ARF

*Assembly Manual*



**HANGAR 9**  
*Fly First Class™*

## Notice

All instructions, warranties and other collateral documents are subject to change at the sole discretion of Horizon Hobby, Inc. For up-to-date product literature, visit <http://www.horizonhobby.com> and click on the support tab for this product.

## Meaning of Special Language

The following terms are used throughout the product literature to indicate various levels of potential harm when operating this product:

**NOTICE:** Procedures, which if not properly followed, create a possibility of physical property damage AND a little or no possibility of injury.

**CAUTION:** Procedures, which if not properly followed, create the probability of physical property damage AND a possibility of serious injury.

**WARNING:** Procedures, which if not properly followed, create the probability of property damage, collateral damage, and serious injury OR create a high probability of superficial injury.



**WARNING:** Read the ENTIRE instruction manual to

become familiar with the features of the product before operating. Failure to operate the product correctly can result in damage to the product, personal property and cause serious injury.

This is a sophisticated hobby product and NOT a toy. It must be operated with caution and common sense and requires some basic mechanical ability. Failure to operate this Product in a safe and responsible manner could result in injury or damage to the product or other property. This product is not intended for use by children without direct adult supervision. Do not attempt disassembly, use with incompatible components or augment product in any way without the approval of Horizon Hobby, Inc. This manual contains instructions for safety, operation and maintenance. It is essential to read and follow all the instructions and warnings in the manual, prior to assembly, setup or use, in order to operate correctly and avoid damage or serious injury.

## Table of Contents

Intro .....	2
Product Support .....	2
Specifications.....	2
Included Parts .....	3
Contents of Kit and Parts Number.....	4
Safety Precautions and Warnings .....	4
3.1m Sukhoi Operating Recommendations.....	5
Important Information Regarding Warranty.....	5
Using the Manual.....	5
Aileron Servos Installation .....	7
Elevator Servo Installation .....	11
Rudder Installation.....	13
Rudder Servos Installation.....	14
Main Gear and Tail Gear Installation.....	15
Pipes/Canisters Mount Installation and Assembly .....	18
Cowl Mounting.....	22
Engine, Throttle Servo and DA Muffler Installation .....	24
Fuel Tank, Fill and Over Flow Installation.....	25
Ignition Module, Battery, Regulator and Switch Installation .....	27
Receiver Mount and Throttle Servo Regulator Installation .....	29
Receiver Battery Installation .....	30
Satellite Receiver and Receiver Switch Installation .....	31
Pilot/Panel Assembly and Installation .....	32
Center of Gravity .....	33
Applying Decals .....	34
Control Throws .....	36
Pro-Tips .....	36
Preflight .....	37
Range Test Your Radio.....	37
Safety Do's and Don'ts for Pilots.....	37
Daily Flight Checks.....	37
Warranty and Repair Policy.....	38
Warranty Services.....	38
Compliance Information for the European Union .....	39
2010 Official Academy of Model Aeronautics Safety Code .....	40

## Intro

Intrigued by the challenge of creating model of the famed full-scale SU-26 Sukhoi that would hold its own against the best of scale acrobatic monoplane designs, Mike McConville stepped up and designed this masterpiece that has exceeded even his highest expectations. The 3.1m wingspan SU-26MM Sukhoi is a no-holds-barred IMAC and 3D/freestyle machine that has already proven itself at the highest levels of IMAC competition.

Finished in Mike's new signature trim scheme for maximum visibility, top to bottom contrast and overall great looks, the 3.1m SU-26MM Sukhoi will deliver best of class performance for any serious pilot wanting uncompromised precision. Having meticulously designed the model to eliminate all roll and virtually all pitch coupling this the Sukhoi has arrow-like tracking that will let you concentrate on perfecting the maneuver at hand without the need to worry about correcting for any unwanted tendencies in the model.

All guess work had been taken out of this ARF, most popular choices for engine, exhaust system and even servo arrangements are covered in the manual. The Hangar 9 3.1m SU-26MM Sukhoi is the ultimate in giant scale acrobatic performance, solid construction, great looks and optimized visual presentation in the air. Enjoy your new Sukhoi and start turning heads at the flying field.

## Product Support

For technical assistance with this product, please contact the appropriate Horizon Product Support office.

## Specifications

Wingspan	122 in (3.1m)
Length	116 in (3m)
Wing Area	2770 sq in (179 sq dm)
Weight	38–42 lb (17.2–19.2 kg)
Radio	4-channel (or greater) with 9–13 servos
Engine	150cc - 170cc gas engine

## Included Parts

### PACKAGED IN KIT

Fuselage with hinged rudder	1
Right horizontal stabilizer with hinged elevator	1
Left horizontal stabilizer with hinged elevator	1
Wings with hinged aileron	1
Cowl	1

### HARDWARE BAGS

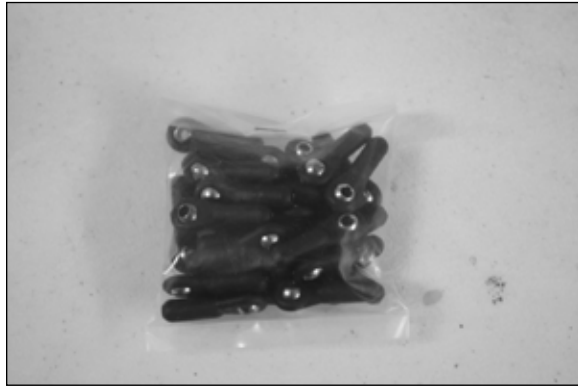

Ball Links



Pushrods, Washers and Locknuts



Aileron and Elevator Control Horns, Plates and Nylon Wing Bolts



2.5mm and 4-40 Screws

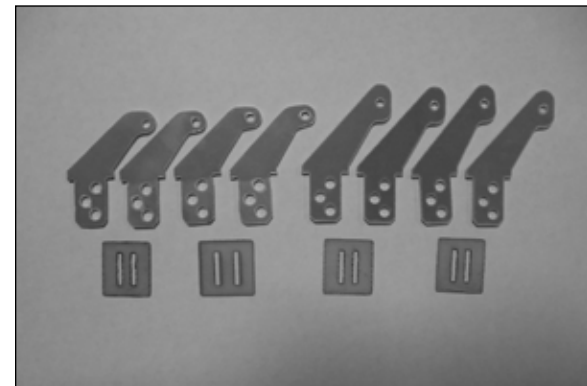

Left Horns (Shorter) are for Elevators and Longer Ones for Aileron

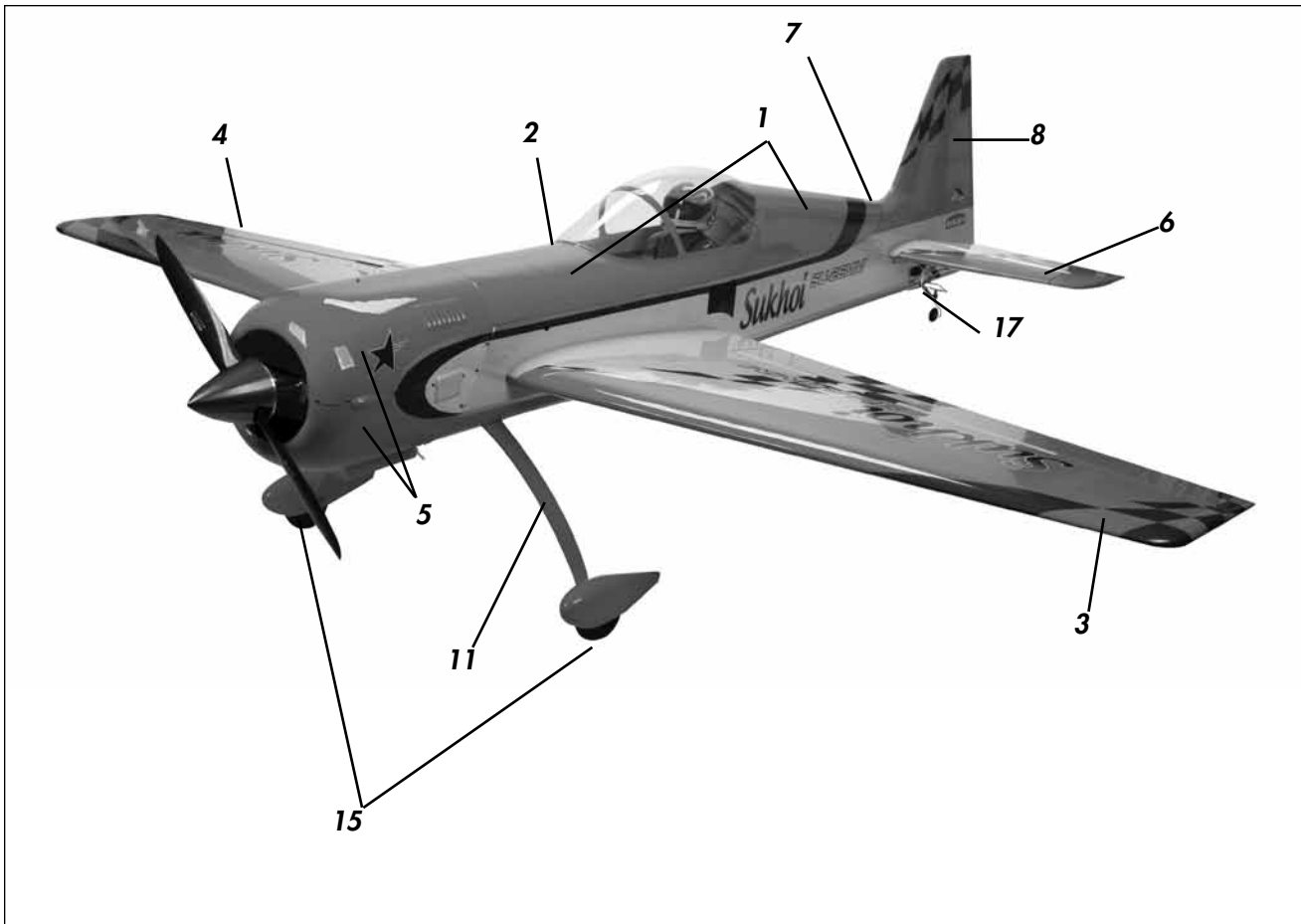

## Contents of Kit and Parts Number

### Replacement Parts

1. HAN106001 Fuselage w/ Hatch, 3.1m Sukhoi MM ARF
2. HAN106002 Hatch w/ Canopy, 3.1m Sukhoi MM ARF
3. HAN106003 Left Wing Panel, 3.1m Sukhoi MM ARF
4. HAN106004 Right Wing Panel, 3.1m Sukhoi MM ARF
5. HAN106005 Cowl (2 piece), 3.1m Sukhou MM ARF
6. HAN106006 Left Stab Panel, 3,1m Sukhoi MM ARF
7. HAN106007 Right Stab Panel, 3.1m SukhoiMM ARF
8. HAN106008 Rudder, 3.1m Sukhoi MM ARF
9. HAN106009 Carbon Wing Tube, 3.1m Sukhoi MM ARF
10. HAN106010 Carbon Stab Tube, 3.1m Sukhoi MM ARF
11. HAN106011 Landing Gear, 3.1m Sukhoi MM ARF
12. HAN106012 Linkage Hdwr Set, 3.1m Sukhoi MM ARF

### Replacement Parts

13. HAN106013 Wheel Pant Set, 3.1m Sukhoi MM ARF
14. HAN106014 Painted Pilot, 3.1m Sukhoi MM ARF
15. HAN106015 Main Wheel Set, 3.1m Sukhoi MM ARF
16. HAN106016 Main Axle Set, 3.1m Sukhoi MM ARF
17. HAN106017 Tail Wheel Assy, 3.1m Sukhoi MM ARF
18. HAN106018 55oz Gas Tank, 3.1m Sukhoi MM ARF
19. HAN106019 Exhaust/Batt Mnt, 3.1m Sukhoi MM ARF
20. HAN106020 Cowl/Cnpy screws, 3.1m Sukhoi MM ARF
21. HAN106021 Decal Set
22. HAN106022 Wing Bolts (6), 3.1m SukhoiMM ARF
23. HAN106023 Fiberglass Control Horn Set

## Safety Precautions and Warnings

Read and follow all instructions and safety precautions before use. Improper use can result in fire, serious injury and damage to property.

### COMPONENTS

Use only with compatible components. Should any compatibility questions exist please refer to the product instructions, the component instructions or contact Horizon Hobby, Inc.

### FLIGHT

Fly only in open areas to ensure safety. It is recommended flying be done at AMA (Academy of Model Aeronautics) approved flying sites.

### PROPELLER

Keep loose items that can get entangled in the propeller away from the prop, including loose clothing, neck strap or other objects such as pencils and screwdrivers. Especially keep your hands away from the propeller as sever injury can occur. Using a thick glove is highly recommended.

### BATTERIES



#### Notes on Lithium Polymer Batteries

When misused Lithium Polymer batteries are significantly more volatile than alkaline or Ni-Cd/Ni-MH batteries used in RC applications. Always follow the manufacturer's instructions when using and disposing of any batteries. Mishandling of Li-Po batteries can result in fire and rupture causing serious injury and damage.

### SMALL PARTS

This kit includes small parts and should not be left unattended near children as choking and serious injury could result.

### Age Recommendation:

For advanced fliers ages 14 and above. This is not a toy.

### 3.1m Sukhoi Operating Recommendations

- Inspect your model before every flight to make certain it is airworthy.
- Be aware of any other radio frequency user who may present an interference problem.
- Always be courteous and respectful of other users of your selected flight area.
- Choose an area clear of obstacles and large enough to safely accommodate your flying activity.
- Make certain this area is clear of friends and spectators prior to launching your aircraft.
- Be aware of other activities in the vicinity of your flight path that could cause potential conflict.
- Carefully plan your flight path prior to launch.
- Abide by any and all established AMA National Model Aircraft Safety Code.

### **Important Information Regarding Warranty**

Please read our Warranty and Liability Limitations section before building this product. If you as the purchaser or user are not prepared to accept the liability associated with the use of this Product, you are advised to return this Product immediately in new and unused condition to the place of purchase.

### **Using the Manual**

This manual is divided into sections to help make assembly easier to understand, and to provide breaks between each major section. In addition, check boxes have been placed next to each step to keep track of each step completed. Steps with a single box (☐) are performed once, while steps with two or more boxes (☐☐) indicate that the step will require repeating, such as for a right or left wing panel, two servos, etc. Remember to take your time and follow the directions.

### **UltraCote® Covering Colors**

- |                |         |
|----------------|---------|
| • Cream        | HANU878 |
| • Orange       | HANU877 |
| • Pearl Purple | HANU847 |
| • Silver       | HANU881 |

### **Recommended Setup—2-Stroke Gas**

- DA150
- DA-170

### **Recommended Spinner**

5-inch purple Tru-Turn Ultimate Style with solid back plate.

- DA150, TT-5052-B-M-3W120-AP
- DA-170, TT-5052-B-M-DA170-AP

### **Optional Tuned Pipe and Canister Installation**

If you are installing the optional tuned pipe, the following items will be required:

- 50mm drop header, 14-inch long for tuned pipe (MTW, RE3) and 8 to 9-inch for canister (MTW TD110)
- Clamps
- Couplers

### **Transmitter Requirements**

The 3.1m Sukhoi requires a minimum of a 4-channel radio to operate all the functions of your aircraft. However to get the best performance from the Sukhoi, a radio with mixing functions is recommended. We suggest the following radio systems available through Horizon Hobby or your local hobby distributor.

Spektrun DX8	SPM8800
JR Systems X9503 2.4GHz	JRP2930
JR Systems 11X 2.4GHz	JRP1100
JR Systems 12X 2.4GHz	JRP1200

### **Radio Equipment Requirements**

The following items are recommended when installing the 9-Channel AR91000 (SPMAR9100) in your aircraft:

DS8911HV Digital Servo (8–12)	JRPS8911HV
JR 537 Servo (1)	JRPS537
12-inch Servo Extension (2) (Ailerons)	JRPA098
18-inch Servo Extension (2) (Ailerons)	JRPA099
24-inch Servo Extension (1) (Throttle)	JRPA102
36-inch Servo Extension (2) (Ailerons)	JRPA103
48-inch Servo Extension (2) (Rudder)	JRPA104
48-inch Servo Extension (2) (Elevators)	JRPA104
(2) Receiver Packs, 4000mAh Spektrum	SPMB4000LP
Ignition Pack 2000mAh Spektrum	SPMB2000LP
JR Charge Switch	JRPA004
JR MatchBox (4)	JRPA900

## ***Additional Required Tools***

Cut-off wheel	Sanding drum
Drill	Epoxy brush
Felt-tipped pen	Ruler
Hex wrench: 1.5mm, 2.5mm, 3mm, 4mm, 4.5mm, 3/32-inch, 5/32-inch	Iron
Hobby knife with #11 blade	Mixing cup
Mixing stick	Paper towel
Pencil	Hemostat
Shoo Goo or Zap-A-Dap-A-Goo	
Phillips screwdriver: #1, #2	Pin vise
Vise grip	Masking tape
Rotary tool	Rubbing alcohol
Nut driver: 1/4-inch	Heat gun
Drill bit: 1/16-inch (1.5mm), 5/64-inch (2mm), 3/32-inch (2.5mm), 3/16-inch (5mm)	

## ***Additional Required Adhesives***

Medium CA	(PAAPT02)
Thin CA	(PAAPT08)
CA remover/debonder	(PAAPT16)
CA accelerator	(PAAPT15)
Threadlock	(PAAPT42)
30-Minute Epoxy, 8 oz	(PAAPT39)

## ***Before Starting Assembly***

Before beginning the assembly of your model, remove each part from its bag for inspection. Closely inspect the fuselage, wing panels, rudder and stabilizer for damage. If you find any damaged or missing parts, contact the place of purchase.

If you find any wrinkles in the covering, use a heat gun or covering iron to remove them. Use caution while working around areas where the colors overlap to prevent separating the colors.



**HAN100 – Heat Gun**

**HAN150 – Covering Glove**



**HAN101 – Sealing Iron**

**HAN141 – Sealing Iron Sock**



## Aileron Servos Installation

### Required Parts

Wing panel  
Control horns (4) (3D wing setup only)  
4-40 screws (12)  
2<sup>7</sup>/<sub>16</sub>-inch aileron pushrod (6) Locknuts (12)

### Required Parts (not included)

JR 8911HV with hardware (4) or (6) or similar digital servo  
JR 1-1/2-inch servo arm (4) or (6)  
JR heavy-duty servo extension, 36-inch (2)  
JR heavy-duty servo extension, 18-inch (2)

### Required Tools and Adhesives

Pin vise  
Thin CA  
Drill bit: 1/16-inch  
String (Dental floss)  
Adhesive-backed hook and loop  
3/32-inch ball driver  
Iron  
Phillips screwdriver: #1  
30-minute epoxy  
Masking tape  
Hobby knife

Wings will be setup with two different configurations, precision and 3D. For the precision setup two servos will be used one is mounted inboard and second servo outboard of the wing. Middle servo bay will be left unused. This is the configuration as the wings come out of the box. For 3D setup, all 3 servos will be installed and middle servo control horns need to be glued in. Follow the below steps.

### Precision Wing Setup

□ 1. Prepare the aileron servos by installing the rubber grommets and brass eyelets.

**Hint:** Prepare all servos for the wing at this time.



□ 2. Secure a 36-inch servo extension to the outboard aileron servo lead using string or a commercially available connector. This will prevent the extension from accidentally disconnecting inside the wing.

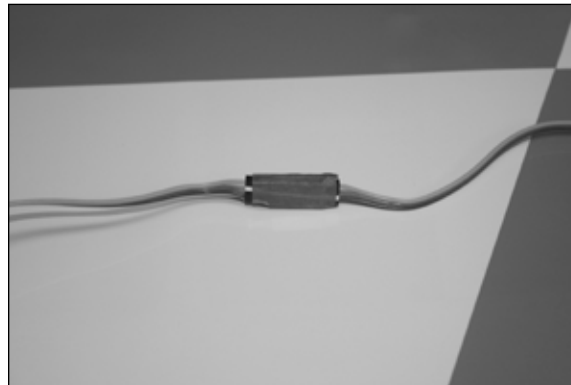

□ 3. In order to harden the servo mounting holes in the bays, mount the servo screws, back them out and apply some thin CA in the hole. Wait until CA is dry before installing the servo. Do this for every bay that a servo is to

be installed in.

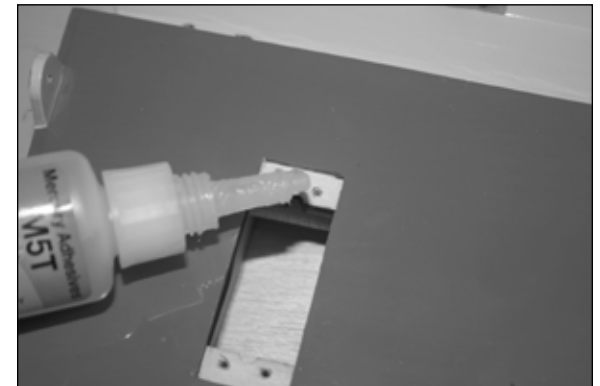
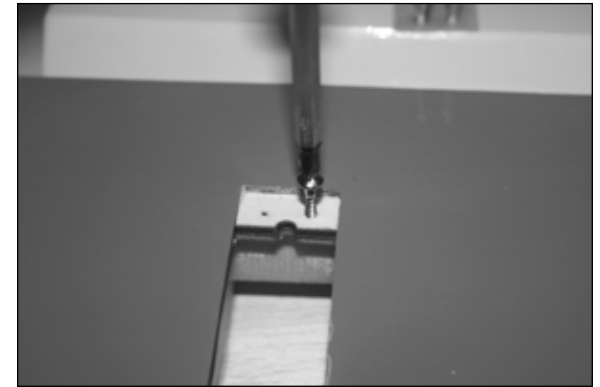

□ 4. A string has been installed in the wing to pull the aileron servo extension through the wing. Tie or tape the string to the end of the extension and pull the lead to the wing root.

□ 5. Mount the servo such that the output shaft faces the leading edge and prepare the linkage for installation.



□□ 6. Attach the linkage to the servo arm at the 1 inch hole. If using aluminum JR arms, use the second hole from center outward. Use threadlock on all the screws except for the two setscrews of the arm.



□□ 7. To adjust the length of linkages, servos need to be powered and at center. The arm should be mounted parallel to the aileron hinge line; small adjustments can be made using sub-trim. Adjust the length of linkage so the aileron is centered and servo arm is parallel to the hinge line.



□□ 8. Mount the inboard servo following the same method as outboard but no extension is required.



□□ 9. Mount the MatchBox™ in the wing root using sticky back hook and loop. Before applying the hook and loop to the MatchBox, apply masking tape to the back of the MatchBox so it can easily be removed when need be.



### **MatchBox Programming Hints**

The pointers below can help make matching servos easier. This is not to take the place of the MatchBox instruction manual.

□ 1. Connect the inboard servo to the MatchBox and then make all adjustments to servo center and travel adjustments in the transmitter programming. No adjustments to this servo should be made in the MatchBox.

□ 2. Connect the second servo to the MatchBox to center it, then install the servo arm onto the servo on the spline that gets it as close to parallel with the hinge line as possible. Then use the MatchBox to set the center of this servo so the servo arm is exactly parallel to the hinge line. Now adjust the linkage length so the hole in the ball link directly aligns with the appropriate hole in the servo arm.

Now deflect the servo to full stick in one direction and use the MatchBox to set the endpoint so the ball link directly lines up with the hole in the servo arm. Repeat this with the stick fully deflected in the opposite direction. Once the center and both endpoints are set for the second servo, remember  
*Hangar 9 3.1m Sukhoi SU-26MM ARF Assembly Manual*



to turn the dial on the MatchBox back to the 0 position to save the settings before powering off the receiver. Hint, when adjusting for endpoints (full deflection), it is hard to hold the sticks and adjust the MatchBox at the same time. It is best to move the sticks to full deflection and while holding the stick, turn off the radio. This will put the receiver into hold and makes adjustment easier working only the MatchBox and observing the linkage position over the servo arm.

### 3D Wing Setup

□□ 1. 3D flying is more demanding and the addition of the middle servo can help reduce the level of abuse servos and wings will see. Open up the middle servo bay. Iron down the edges. The middle servo bay is located approximately 16 inches away from the inboard servo. Rub your finger over the covering in that vicinity to find it.

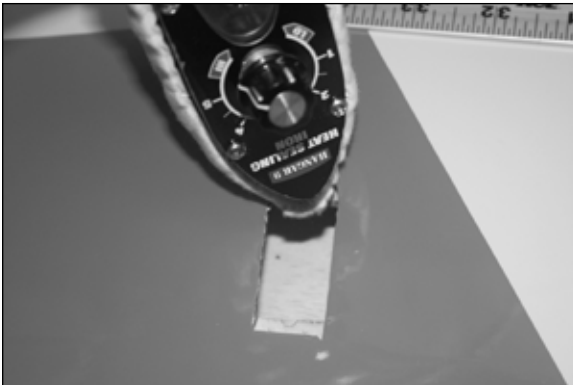
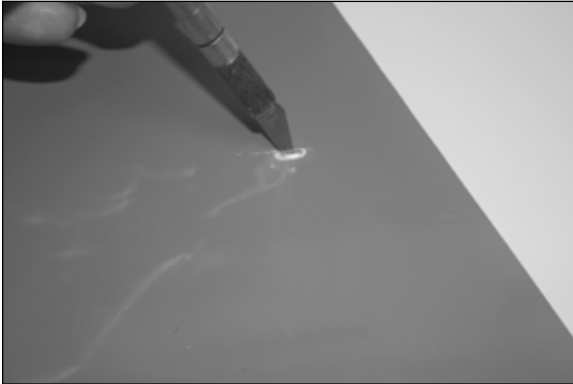

□□ 2. To harden the servo mounting holes in the bay, mount the servo screws, back them out and apply some thin CA in the hole. Wait until CA is dry before installing the servo. See step 3 in precision wing setup for detail.

*Hangar 9 3.1m Sukhoi SU-26MM ARF Assembly Manual*

□□ 3. Find the location for control horns and remove the covering in between the two slots. Now place the plate over the slots and mark a slightly smaller area than the plate and remove the covering.

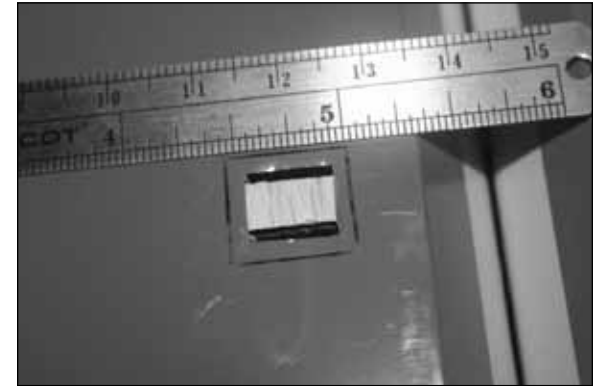
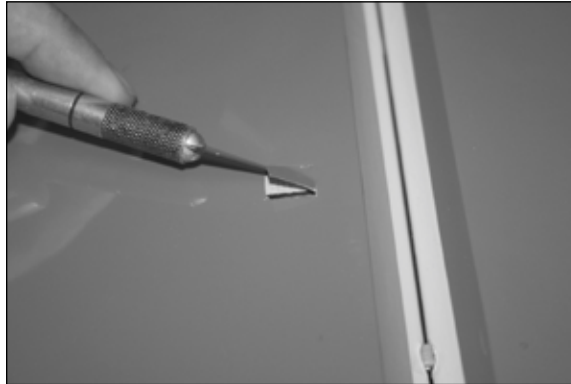
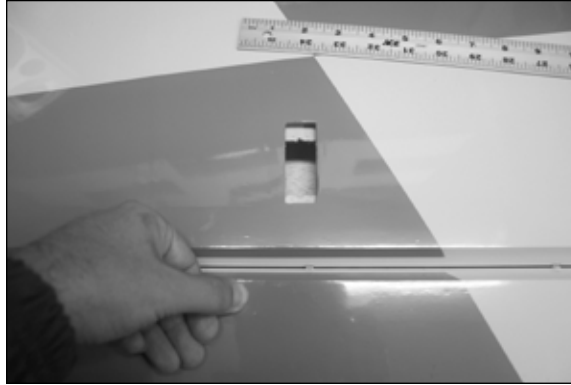

□□ 4. Mix 30-minute epoxy and glue the horns and plate such that the control horn pivot point is aligned with aileron hinge line. Apply epoxy to both slots on the aileron and control horn and plate. Clean excess with alcohol swabs.



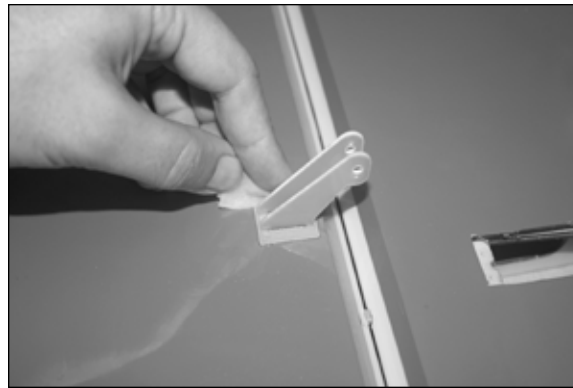
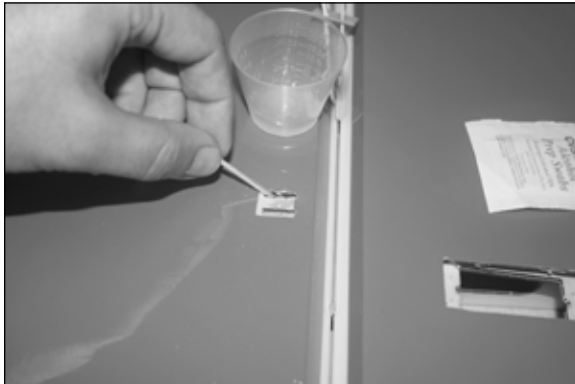

□□ 5. Attach an 18-inch JR Heavy-Duty extension to the middle servo. Mount the servo such that the output shaft is towards the leading edge of the wing.



□ 6. 1.5-inch servo arms are used for 3D wing setup. Assemble the linkages and use threadlock on all the screws. Setscrews need only tightening and no threadlock.

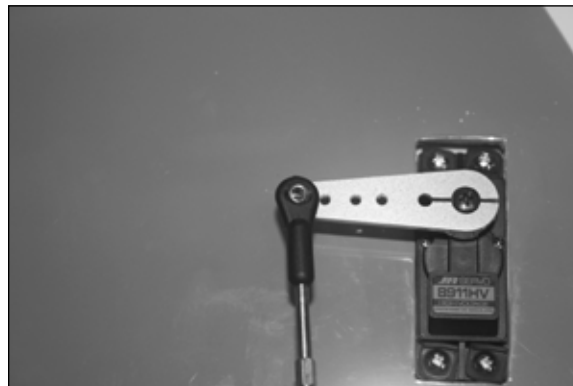

□ 7. The picture below shows the wing with a 3-servo setup at full deflection. For MatchBox setup, refer to previous section.



The picture below shows the comparison of precision wing and 3D wing setup.

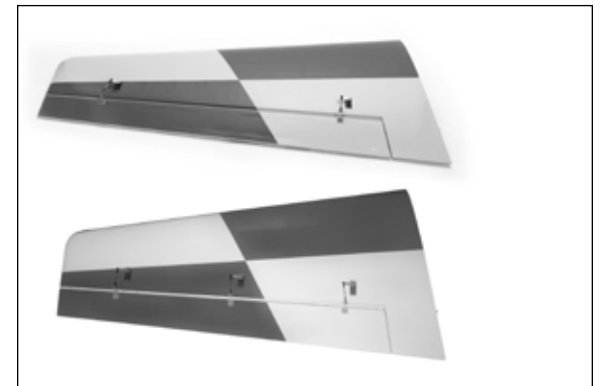

## Elevator Servos Installation

### Required Parts

Elevator panel	4-40 screws (8)
Locknuts (8)	Ball link (8)
Control horns (4) (3D elevator setup only)	
2 <sup>7</sup> / <sub>16</sub> -inch elevator pushrod (4)	

### Required Parts (not included)

JR 8911HV or similar digital servo (2) or (4)
JR 1.5-inch servo arm (2) or (4)
JR heavy-duty servo extension, 48-inch (2)

### Required Tools and Adhesives

Pin vise	Iron
Thin CA	Phillips screwdriver: #1
Drill bit: 1/16-inch	30-minute epoxy
String (Dental floss)	Masking tape
Adhesive-backed hook and loop	
3/32-inch ball driver	Hobby knife
2.5mm ball driver	

Note: Elevators will be set up for both precision and 3D flying. Due to extra demand in power and deflection of 3D flying, two servos will be used for that style.

## Precision Setup

1. For precision setup one servo per elevator is used. Prepare the servo by installing the rubber grommets and brass eyelets.



Servo needs to be installed in such way that output shaft is  
*Hangar 9 3.1m Sukhoi SU-26MM ARF Assembly Manual*

towards the leading edge of the stab. The servo arm needs to be 1.25 inch; if in case of using a JR aluminum servo arm, this would be the third outermost hole.

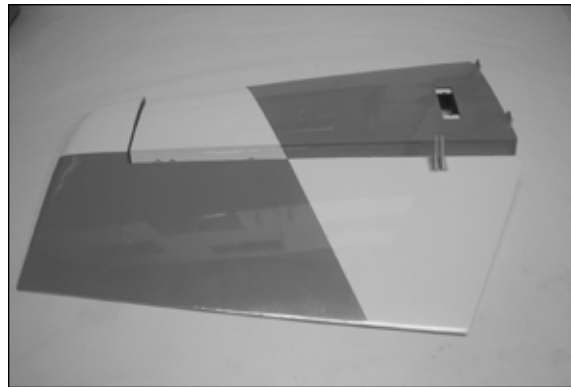

2. Mount the servo screws and back them out.

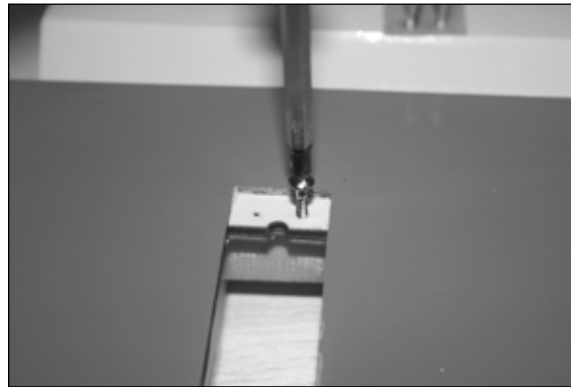

3. To harden the servo mounting holes in the bay apply some thin CA in the hole. Wait until CA is dry before installing the servo.

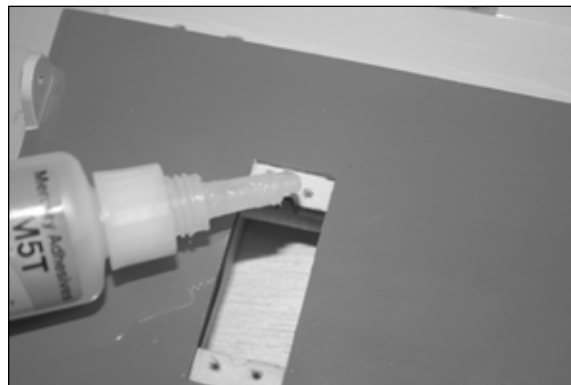

4. Mount the servo so the output shaft is towards the leading edge of the stab.



5. Prepare the ball link and pushrod. Attach the ball link to the control horn using a 2.5mm ball driver and hold the locknut with help of a vise grip or nut driver.



6. Connect the ball link to the 1.25-inch hole on a JR aluminum servo arm. This would be the third outermost hole from the center of the arm. Mount the servo arm parallel to the elevator hinge line. Use threadlock on the center servo arm screw. Use a 48-inch JR Heavy-Duty extension from elevator to receiver.

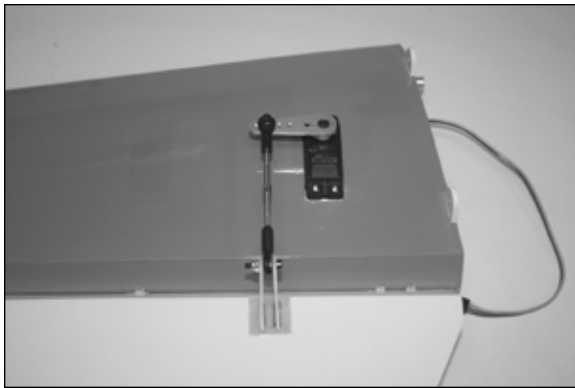

### 3D Elevator Setup

□□ 1. The second servo bay needs to be opened and control horns and plate need to be glued using 15- to 30-minute epoxy. This step is also very similar to Aileron Servo Installation in 3D section. Follow the same steps and make sure to line up the control horn pivot point to the elevator hinge line.



□□ 2. Mount the servo screws and back them out. Apply some CA to harden the wood. This step is the same as steps 2 and 3 in the elevator precision setup section.

□□ 3. Mount the servo once the glue is dry.



□□ 4. Remove the covering to mount the control horns.

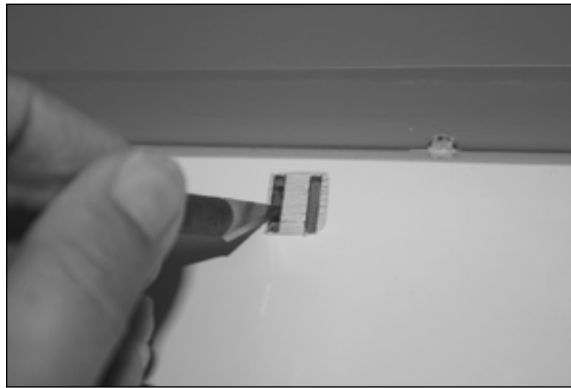

□□ 5. Mix 30-minute epoxy and fill the control horn slots.

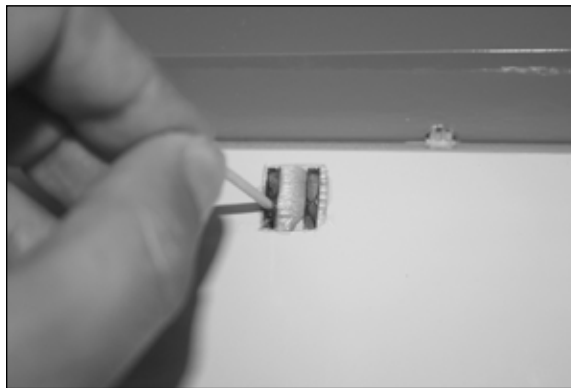

□□ 6. Install the control horns and plate, make sure to line up the control horns hole and elevator hinge line. Clean excess epoxy using alcohol swabs.

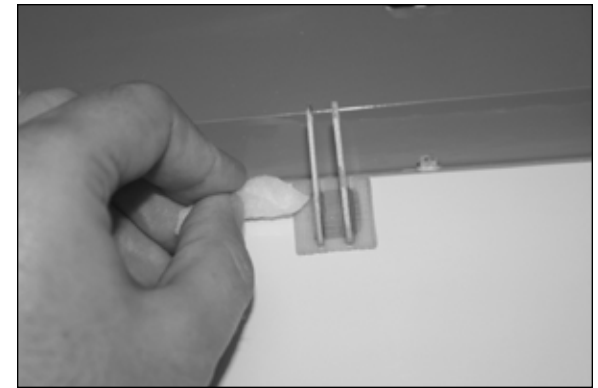

□□ 7. Prepare the ball link and pushrod for installation.

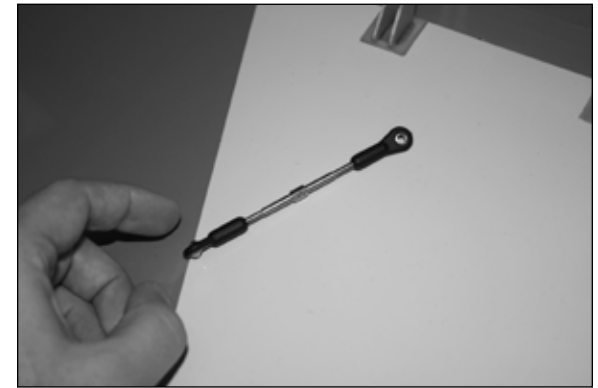

□□ 8. Install the ball links at the 1.5-inch hole on the arm. Use threadlock on the center servo arm screw.



□□ 9. MatchBox is installed in the stab root. Apply a piece of masking tape to the bottom of the MatchBox and using CA glue a piece of hook and loop to the MatchBox.



10. Glue opposite side of hook and loop to stab root with CA.



11. Mount the MatchBox. Use 48-inch extension from MatchBox to the receiver.

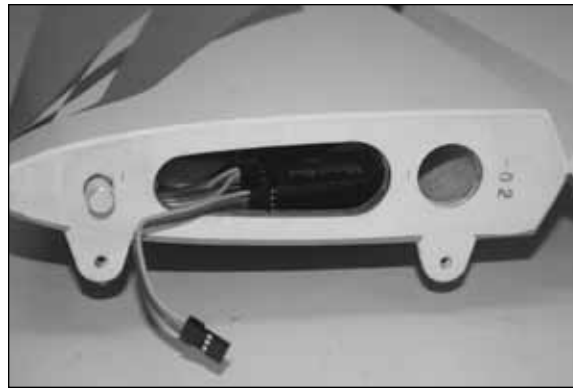

Note: Refer to MatchBox setup in the wing section.

## Rudder Installation

### Required Parts

Fuselage	Rudder
Hinge rod	

### Required Tools and Adhesives

Drill	Pliers
Petroleum Jelly/Industrial lubricant	

1. Apply some industrial lubricant to the rod. Pass the rod through the hinges in rudder and fuselage vertical fin separately. This helps remove any possible dirt in the hinges and makes for easier final assembly.



2. Mate the rudder and fuselage vertical stabilizer and carefully pass the rod through hinges. This can be accomplished by two ways. 1. Use a drill on slow speed and gently pass through the rod. If there is any resistance, back out and repeat. 2. Use a pair of pliers and push the rod through the hinges. Make sure not to buckle the rod. This is a rather slow process and needs attention.





□3. Cut excess rod long enough (1mm) that it is easy to grab and pull out when needed for transportation. The tail wheel bracket will stop the rod from backing out of the hinges.



The picture below shows the rod at top end of the vertical fin.



## Rudder Servos Installation

### Required Parts

Fuselage	4-40 screws (4)
Ball link (4)	Locknuts (4)
3 <sup>3</sup> / <sub>16</sub> -inch rudder pushrod (2)	

### Required Parts (not included)

JR 8911HV or similar digital servo (2)
JR 1.5-inch servo arm (2)
JR heavy-duty servo extension, 48-inch (2)

### Required Tools and Adhesives

Pin vise	Phillips screwdriver: #1
String (Dental floss)	Masking tape
3/32-inch ball driver	

Note: The fuselage is made to accept 4 rudder servos, however if the recommended servos are used, only two servos are needed even for the most extreme 3D flying. If using servos with lower torque, remove the covering from one or both of the additional servo bays and connect linkages as needed.

□ 1. Prepare the servo by attaching the 48-inch extension and securing the connector with a string and masking tape over it.



□ 2. Servo is mounted with output shaft facing aft. Mark the servo mounting lugs.



□ 3. Use a pin vise to drill the holes.



4. Mount the servo screws and remove.

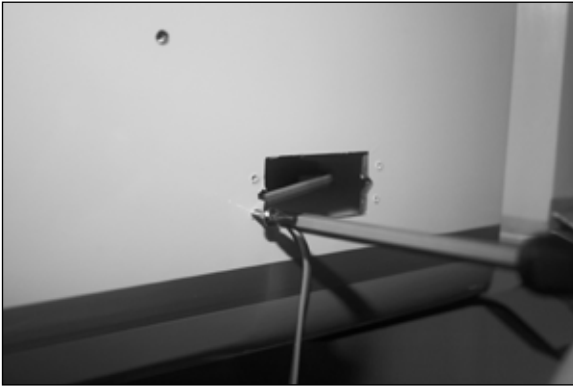

5. Apply some thin CA to harden the wood. Once glue is dry, mount the servo.



6. Prepare the servo arm by mounting the ball link and pushrod at 1.5-inch hole out.



7. Power up the servo and with sub-trim at 0, mount the  
*Hangar 9 3.1m Sukhoi SU-26MM ARF Assembly Manual*

servo arm so it is pointing to the bottom of the fuse and is parallel to the rudder hinge line. Use sub-trim if needed.



8. Apply threadlock on main mounting servo screw. Tighten the setscrews without use of threadlock.



9. Connect other side of pushrod to control horns.



10. Adjust the length of pushrod to achieve rudder center while the arm is parallel to the hinge line.

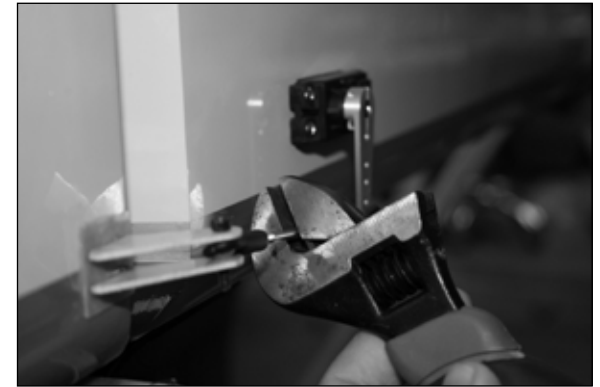

Note: Since there are two rudder servos used (one on each side), they can be matched in the radio using an Aux and P-Mix or using a MatchBox.

## Main Gear and Tail Gear Installation

### Required Parts

Landing gear	Landing gear hardware
Wheel pants	Wheels

### Required Tools and Adhesives

2.5mm ball driver	10mm wrench and socket
Crescent wrench	4.5mm ball driver
Threadlock	Felt-tipped pen
Thin CA	Pin vise

1. Locate all the hardware necessary to mount the wheels and wheel pants.

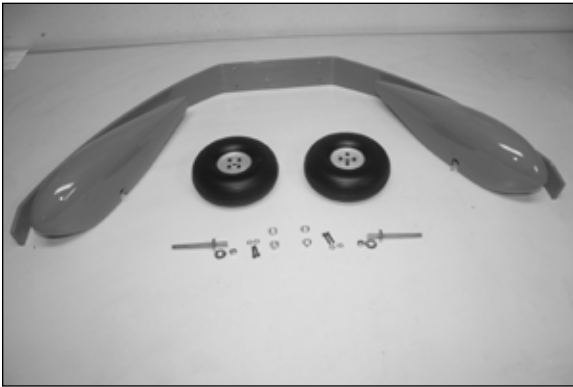

2. Mount the axles with locknut and washer provided in the kit using a crescent and a #10 wrench.



3. Install the wheel using the two wheel collars provided; apply threadlock to the setscrews and slightly tighten them.



4. Temporarily install the pant and center the wheel.



5. Once the wheel is centered, remove wheel pant and mark the axle where wheel collars sit and file a flat spot for each collar location. Note that the collar shoulder is facing the wheel hub.



6. Tighten the setscrews and wheel pant screws using a 1.5mm and 2.5mm ball driver respectively.

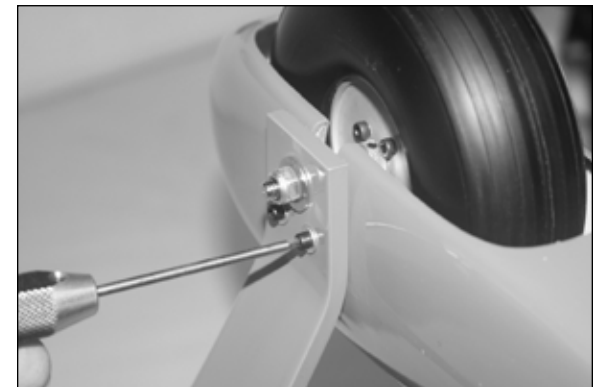

7. Mount the main gear using (4) 5mm bolts/washers and locknuts. Use threadlock on the bolts. Hold the nut either from inside the canister tunnel or from the top through the slots in the fuselage floor at the sides of the tank tray. Here the locknut is shown being held using a ratchet with a #10 socket from inside the canister tunnel. Gear needs to be installed with

angle slightly swept forward.

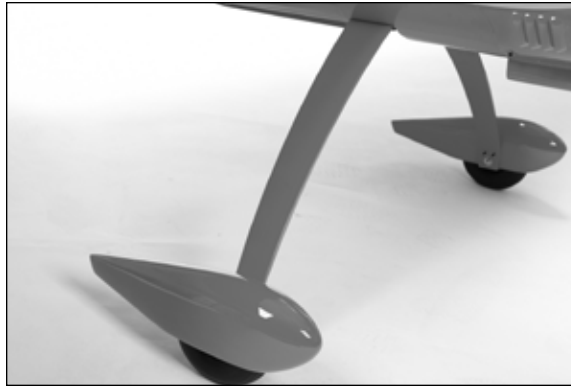
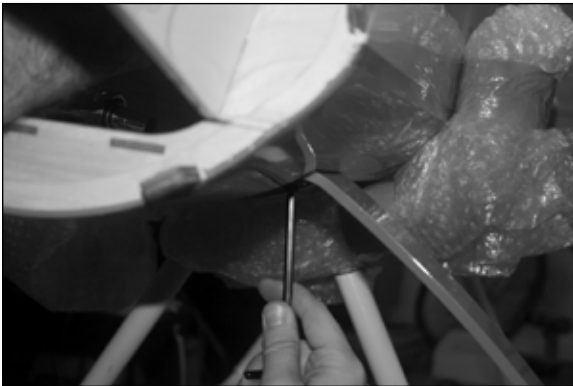
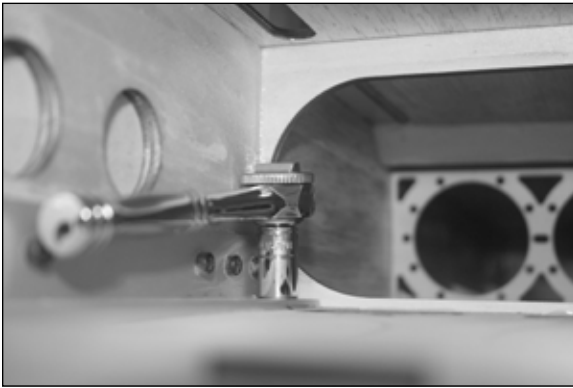

8. Tail gear is mounted using (3) 4-40 ½ inch screws and 3 washers included in the kit.



9. Mount the T-bracket and mark the holes.

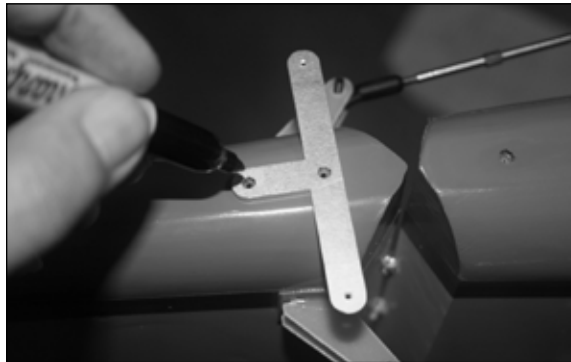

10. Drill a pilot hole using a pin vise, then mount the screws and remove them.

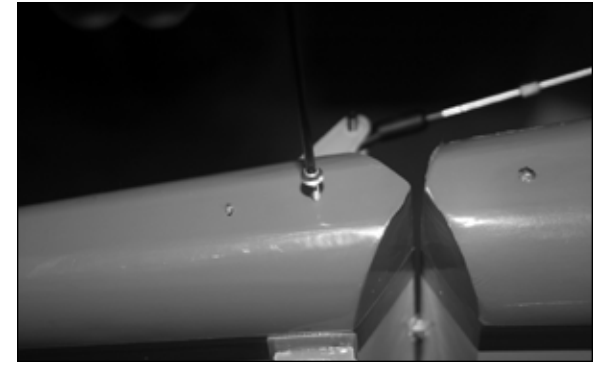

11. Apply thin CA in the holes and wait until it is dry, this will harden the wall.

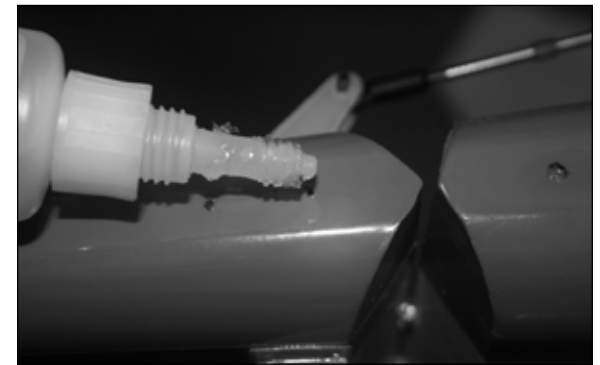

12. Mount the T-bracket using small wood screws and the tail gear using washers and screws; make sure to use threadlock on the bolts. Hook the springs from the tiller arm to the T-bracket and secure them.



## Pipes/Canisters Mount Installation and Assembly

### Required Parts

Pipe or canister mounts      Silicone tubing

### Required Parts (not included)

MTW RE3 Pipe                      MTW 110 Canister  
50mm drop header, 14-inch for RE3 tuned pipe setup  
50mm drop header, 8-9-inch for MTW 110 canister setup  
Couplers                              Clamps

### Required Tools and Adhesives

Hobby knife                          Felt-tipped pen  
5-and 30-minute epoxy              Clamps  
Vise grip                              Iron  
Rotary tool with cutter disk          Ruler  
Masking tape                          Industrial lubricant  
Acid brush                              Mixing cup and sticks

### Pipes Mount Installation

□ 1. Kit comes with 4 pipe mounts, 2 canister mounts and silicone tubing. Two support locations are selected for pipe installation. Pipe mounts need to be doubled up for increased glue surface area and strength. Scratch the surface of each mount with a hobby knife.

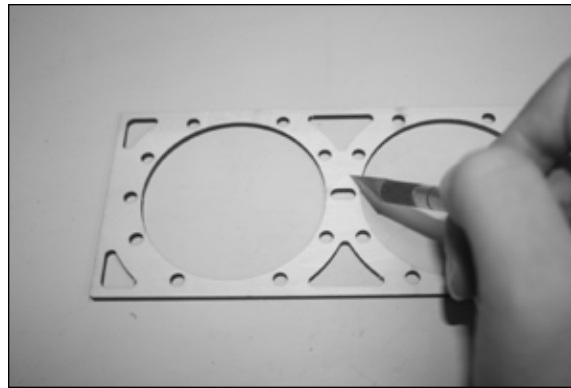

□ 2. Glue the layers using a thin layer of 5-minute epoxy. Clamp until glue cures.

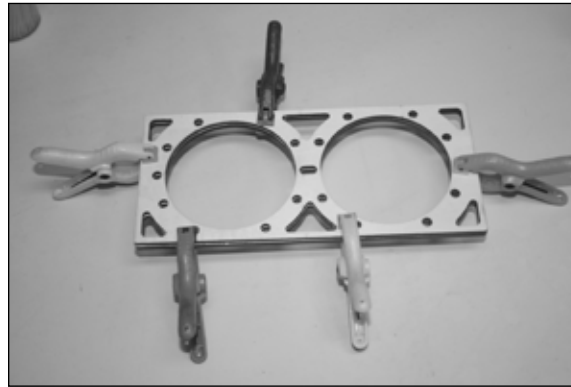

□ 3. Pass the silicone tubing through the middle hole and go through each hole in the circumference of the mount from the inside until you are back at the same middle hole that you started. Cut off the silicone tubing to prepare the next pipe mount.

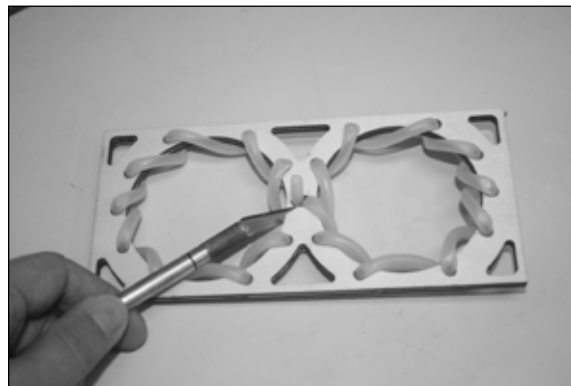

□ 4. Prepare the fuselage for pipe installation. Remove the covering as pictured and iron down the edges. Masking tape can be used to give good guidance when cutting.

Note: Final picture is shown below to give a good perspective as where to remove the covering.



The picture below is of the bay immediate aft of landing gear.





The picture below is of the tail end of the pipe tunnel.

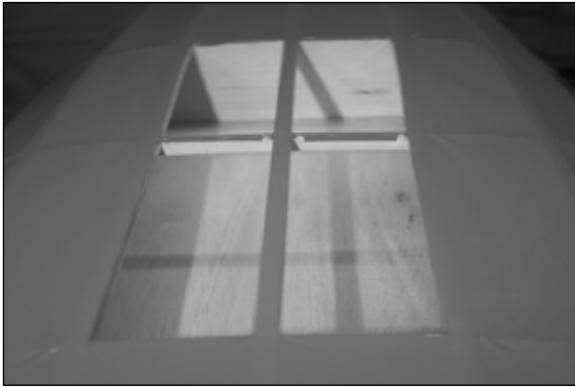

□ 5. Temporarily mount the pipe mounts and install pipes to center the mounts before they are glued. Use lubricant on the pipes for easier passage through the mounts when they are not glued yet. Pipe mounts will not touch the floor of the fuselage and need to be glued to the sides and bottom former.

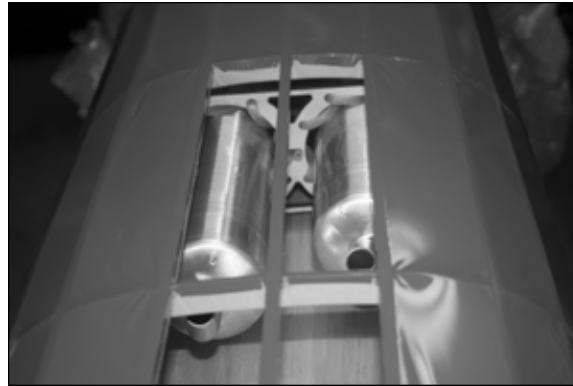

□ 6. Once mounts are centered mark the spot on the sides and formers.

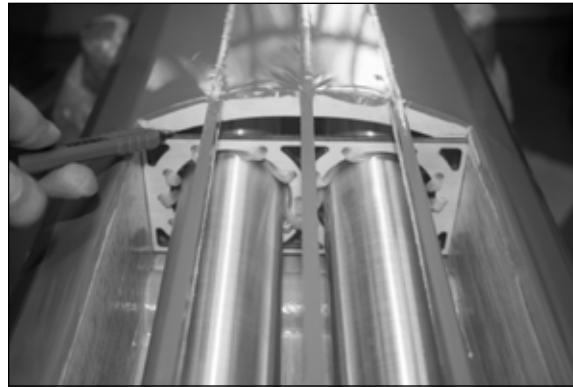

□ 7. Remove the pipes and use an acid brush to apply 30-minute epoxy to the sides of the mount and fuselage.

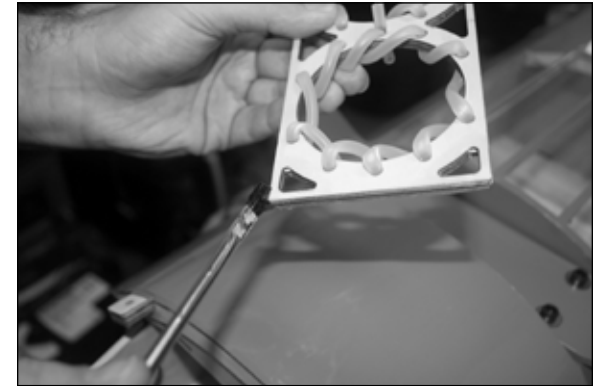

□ 8. Reinstall the mounts and allow time for epoxy to cure.



## Pipe Header Assembly

- 1. Recommended header length for MTW RE3 tuned pipe and DA-170 is 14 inches. Assemble the pipe/header using a vice-grip. Open the clamps and slide them over the header.

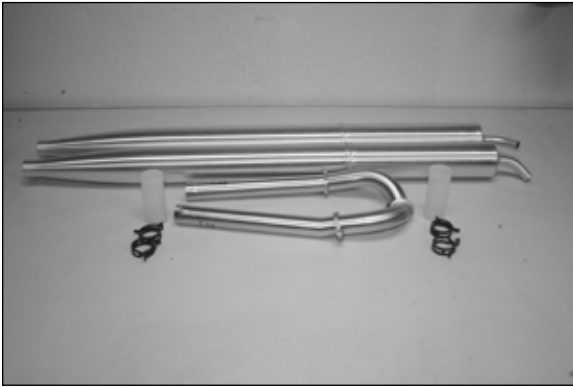

- 2. Insert the header and pipe into coupler, leave 1/8--1/4 inch gap between header and pipe. Slide the clamps on the

pipe and header, such that it is forward the bump on the header and over the grooves on the pipe/canister.

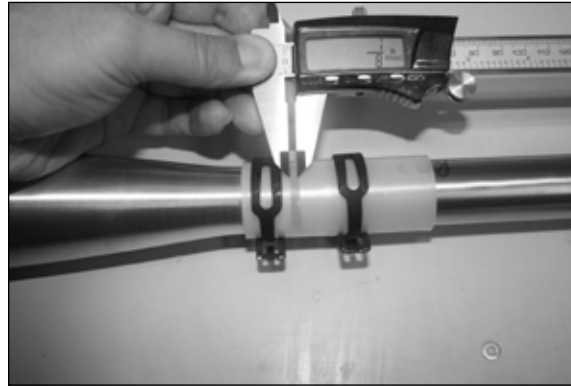

- 3. Once everything is assembled, heat the couplers where clamps are using a heat gun at high setting. Do this for a few minutes and allow some time for cooling. Repeat this one more time. This will create a good grip and reduces chance of pipe/header slipping out in flight. It is also recommended to do this before the first flight. Let engine idle for 3 to 4 minutes to warm up the couplers, gradually increasing the throttle to half to get the engine hot and then allow a cool-down period before the first flight. This should not need repeating and when done right, header/pipe will not slip out.

## Canisters Mount Installation

- 1. Kit comes with 2 canister mounts and silicone tubing. There is only one support location for the canister mount that is under the landing gear area. Scratch the surface of each mount with a hobby knife and glue the layers using a thin layer of 5 to 15-minute epoxy. Clamp until glue is cured. Pass the silicone tubing through the mount start with top middle hole and end at bottom middle hole as shown in Pipes Mount Installation section.



- 2. Prepare the fuselage for canister installation. Remove the covering as pictured in first bay, under the landing gear and iron down the edges.

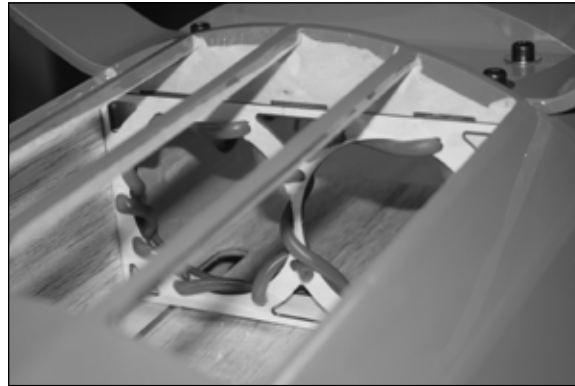
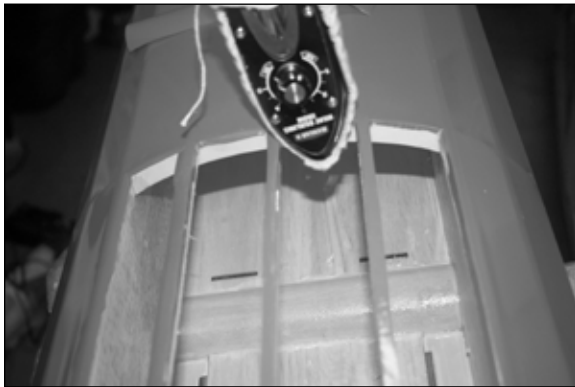
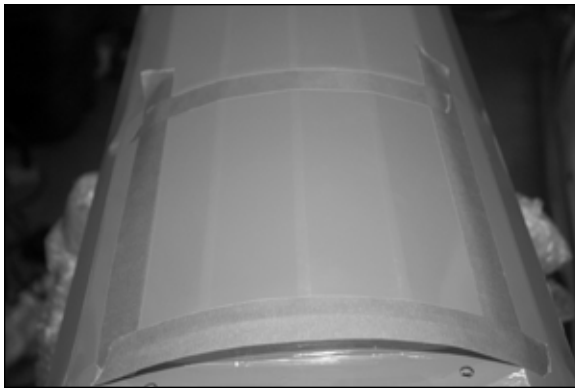

## Canister/Header Assembly

□ 1. Recommended header length for MTW TD110 canister and DA-170 is 8--9-inches. Cut 1 inch off the stock header. Assemble the canister/header using a vice-grip to open the clamps and slide them over the header first then insert the header and canister into coupler. Leave 1/8--1/4 inch gap between header and pipe. Since the bump on the header has to be cut for optimum performance, tap a button head 4-40 screw on the header and slide the slot of the clamp over the button head screw and coupler to avoid slippage.



□ 3. Temporarily mount the canister mounts and install canisters to center the mount. Use lubricant on the canisters for easier passage through the mounts before they are glued. The canister mount touches the floor of the fuse and needs to be glued to the sides and bottom former. Once mount is centered, mark the spot on the sides and formers. Remove the canisters and apply glue to the sides of the mount and fuselage where they contact using 30-minute epoxy to enough have time for adjustment.

## Cowl Mounting

### Required Parts

Cowl mounting ring                      Gussets  
Lower cowl  
Lower cowl mounting hardware

### Required Tools and Adhesives

30-minute epoxy                      Hobby knife  
Iron                                        3/32-inch ball driver

1. The pictures below show the cowl mounting ring and 3 gussets. They assemble as pictured. Mount the cowl mounting ring and open the slots where the gussets sit on and around the engine box.

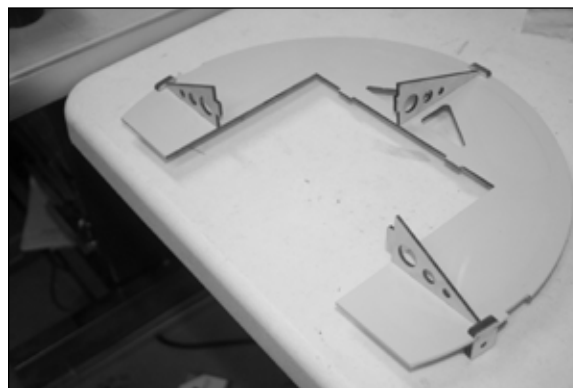
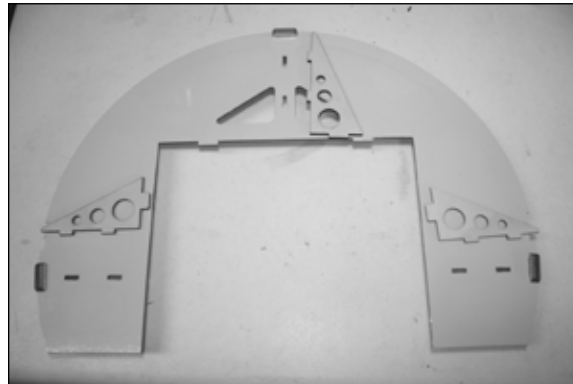
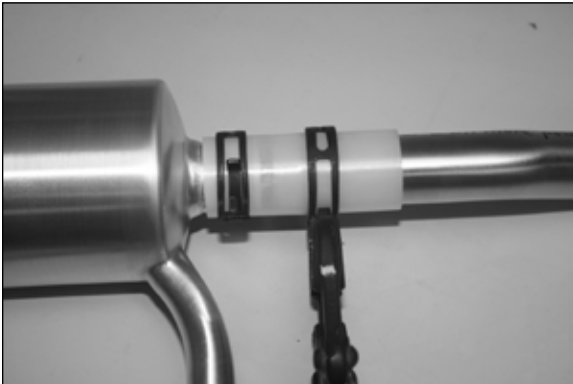
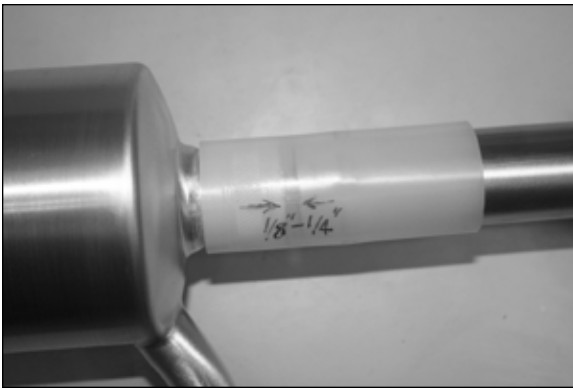

2. Dry fit everything and temporarily mount the bottom cowl to ensure correct alignment. Adjust if necessary.

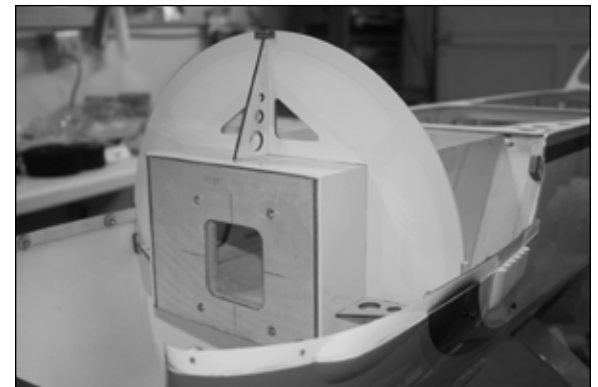
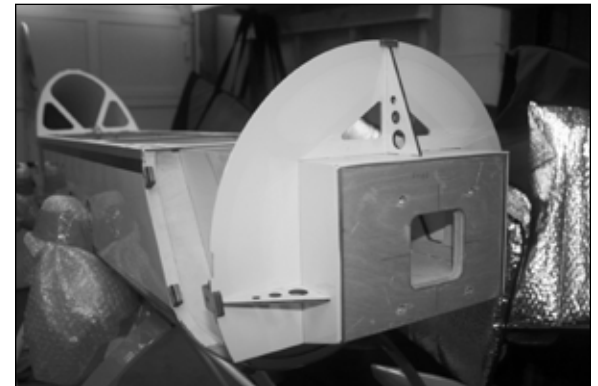

□ 3. Mark where the cowl mounting ring and gussets touch the engine box and remove the covering before applying epoxy. The picture below shows where the gusset attaches to the cowl mounting ring and engine box.

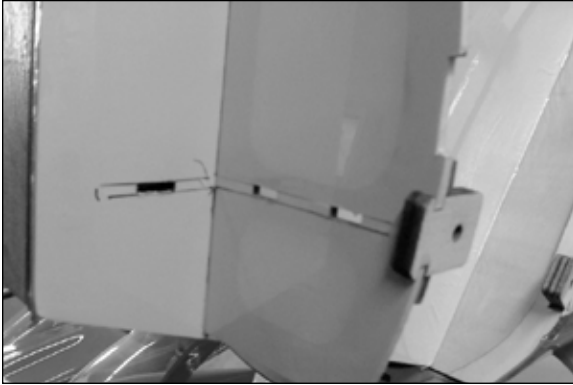

□ 4. Mix 30-minute epoxy and apply glue to the gussets and cowl mount ring, also rub some epoxy in the slots where the gusset tabs interlock, then glue the mounts in place. Attach bottom cowl and wait until epoxy is set before removing the cowl. This ensures the cowl mount ring and gussets are glued and aligned properly. Clean excess epoxy with alcohol swabs.

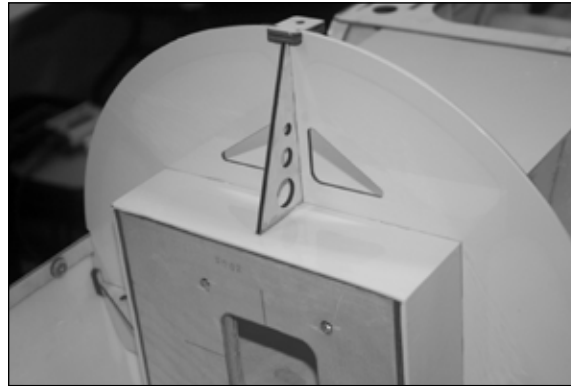
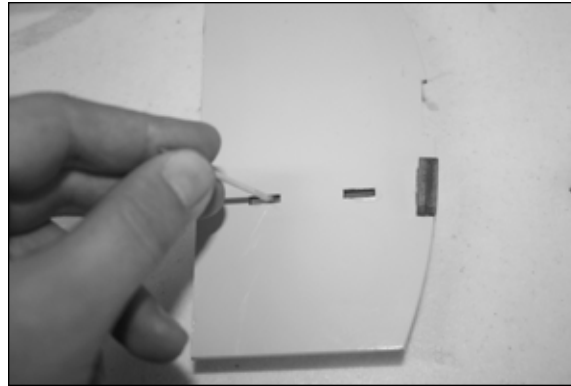
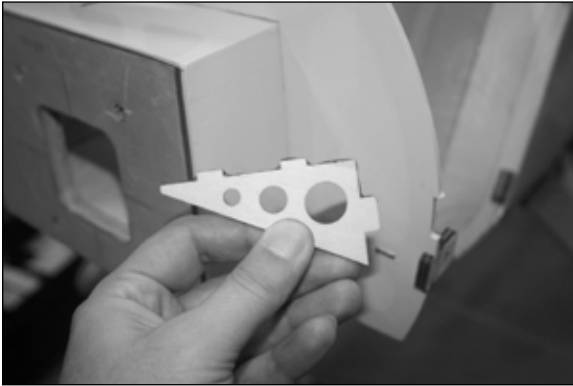

□ 5. Mount the lower half cowl.

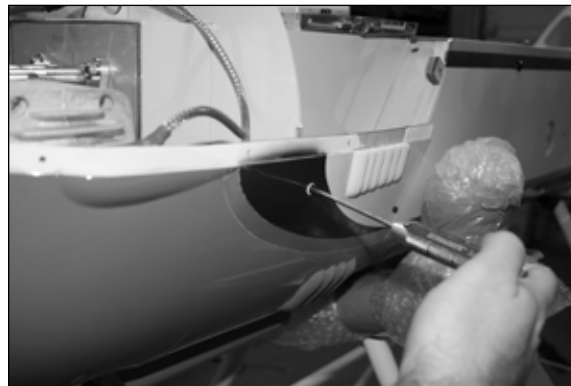

□ 6. Mount the upper half cowl. At the mid-point that both lower and upper half meet, use colored washers and 1/4 inch 4-40 screws.





## Engine, Throttle Servo and DA Muffler Installation

### Required Parts

1/4-20 1-inch bolts (4)

### Required Parts (not included)

DA-170 Engine  
JR-537 servo (1)  
JR 24-inch servo extension

### Required Tools and Adhesives

Threadlock  
Hobby knife with #11 blade  
Pin vise  
Rotary tool with sanding drum  
4.5mm hex wrench  
Felt-tipped pen  
Phillips screwdriver

□ 1. Mount the engine using 1-inch 1/4-20 bolts provided and make sure to apply threadlock to all the bolts.



□ 2. Mount the throttle servo so that the servo output shaft is closer to the front of the engine. DA-170 comes with a 4-40 ball link attached to the throttle lever. Screw the 6 1/2-inch 4-40 rod into DA ball link and ball link provided with the kit. Apply threadlock to the servo arm screw. Throttle servo needs 24-inch extension.

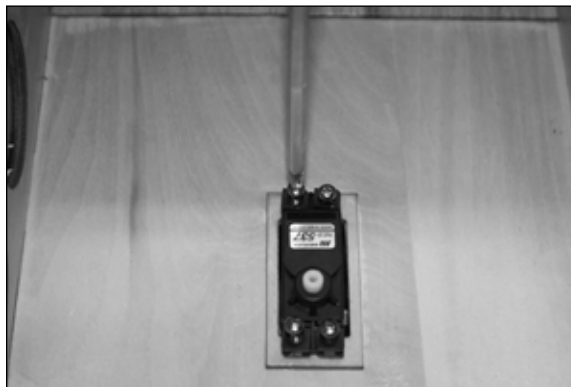

□ 3. Install the mufflers so DA logo on the muffler is pointed towards the front and smoke nipples are facing outboard of the plane on both sides. Use gasket provided or high-temperature RTV and apply threadlock to the muffler bolts.



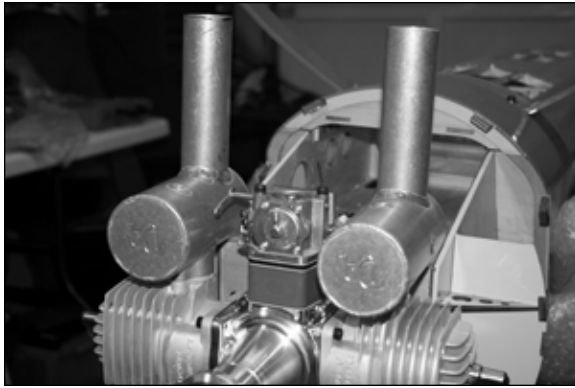

4. Use cutting disk, drum sander and a rotary tool to cut the cowl. Holes need to be at least 1/4 inch larger than muffler stack diameter.

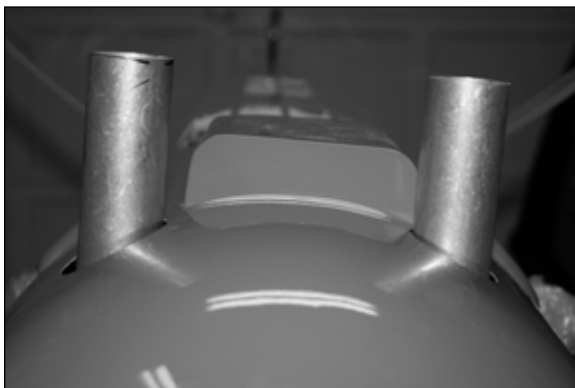
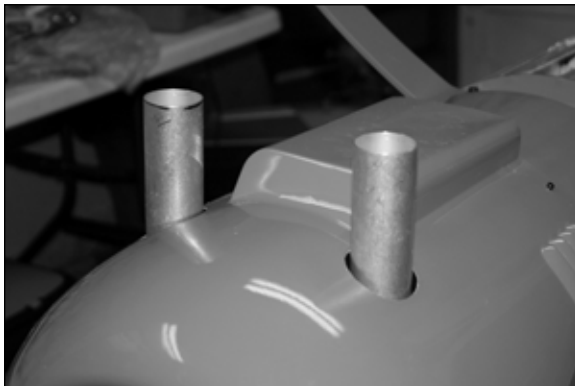

## Fuel Tank, Fill and Over Flow Installation

### Required Parts

Fuselage

Fuel tank

### Required Parts (not included)

Hangar 9 Fuel filler and T

### Required Tools and Adhesives

Drill and bits (1/16-inch, 1/8-inch)

Zip tie

Hemostat

Double-sided tape or adhesive-backed hook and loop

Medium CA

Hook and loop straps

Rotary tool

Sanding Drum (3/8-inch)

1. Fuel tank comes assembled but not installed. It is recommended that lines be checked every 2-3 months and replace them if they have hardened.

2. Fill line is installed at the front left side of the fuselage using Hangar 9 fuel filler. Drill a small hole; then using a rotary tool and 3/8-inch diameter sanding drum or grinding bit, open the side of the fuselage for the fuel filler.

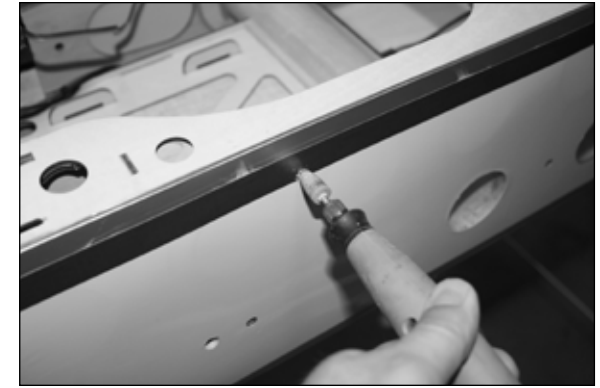

3. Tank fill line goes to a T. Use the straight path outlet to connect to carb and other to fuel filler. Wrap safety wires around the lines.



□ 4. To secure the fuel tank from forward/aft motion, double-sided or servo tape should be applied to the bottom of the tank. There is no foaming issue with hard-mounted tanks in gas engines.

For removable setup, apply a couple of pieces of masking tape to the bottom of the tank.

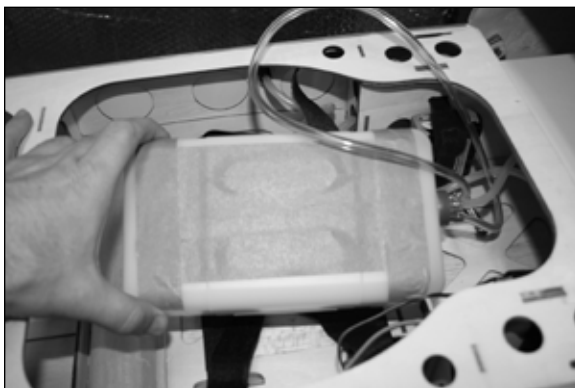

□ 5. Glue a piece of hook and loop to the masking tape using medium CA.

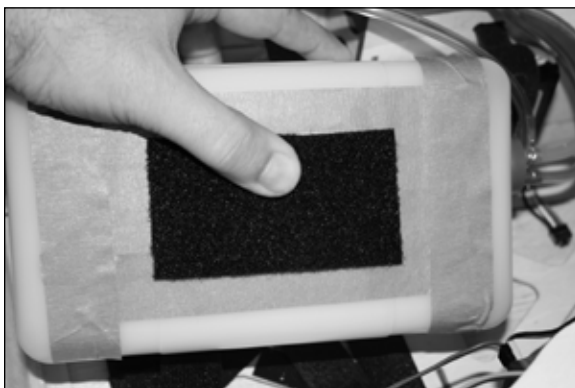

□ 6. Glue two pieces of hook and loop to the tank tray using medium CA.



□ 7. Strap the tank with hook and loop strips provided. Loop the overflow line around the tank.



□ 8. Overflow line goes through the fuselage floor opening to the lower bottom cowl.



□ 9. Mount the lower cowl and mark behind the bottom left louver. Use rotary tool to open the lower cowl, big enough to pass the overflow line.

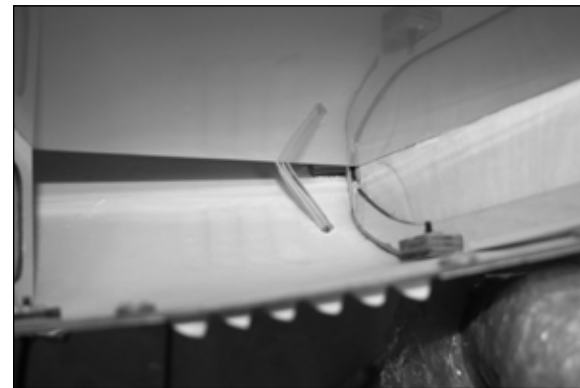
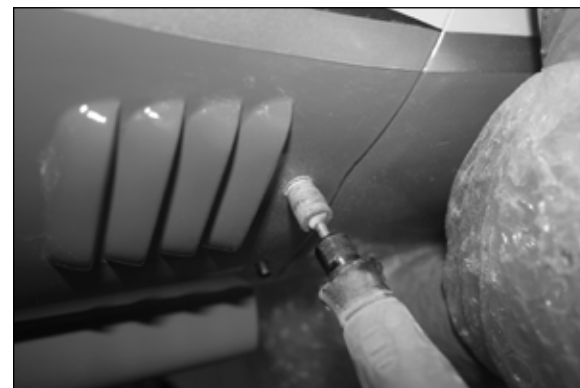

□ 10. Cut 1/4-inch fuel line.

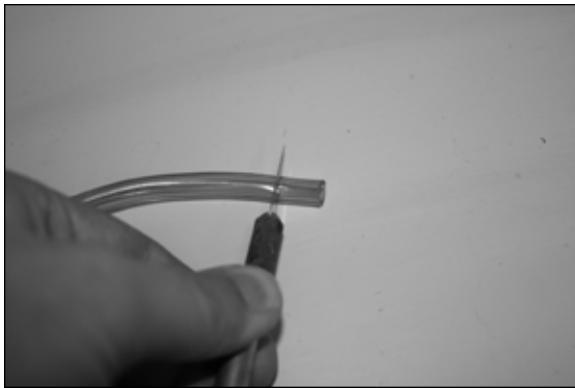

11. To help prevent the line from going back inside the cowl, open up the fuel line with use of hemostat and pull over the overflow line.

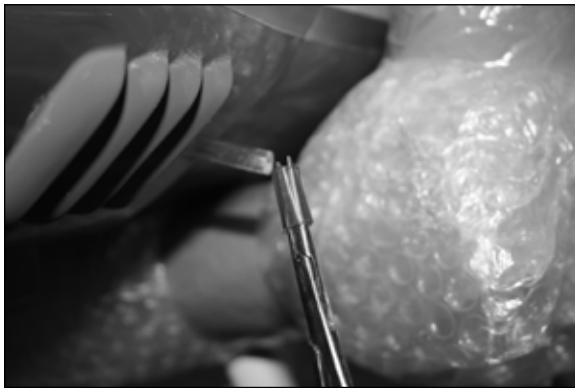

## Ignition Module, Battery, Regulator and Switch Installation

### Required Parts

Fuselage

### Required Parts (not included)

JR 5203 regulator                      Ignition Module  
 Ignition Battery, 2000 2-cell Spektrum  
 JR heavy-duty switch or similar  
 JR heavy-duty 6-inch extension

### Required Tools and Adhesives

Hobby knife                              Iron  
 Masking tape                            Medium CA  
 Hook and loop                           Double-sided tape

1. Locate the ignition switch cut out in the right front of the fuselage and remove the covering. Mount the ignition switch.

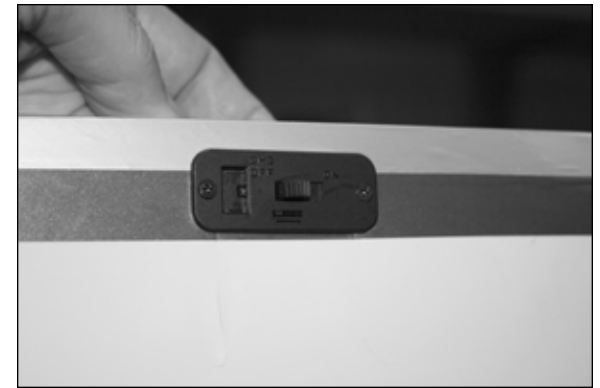

2. Locate the slots for the ignition module behind the cowl mounting ring and remove the covering.

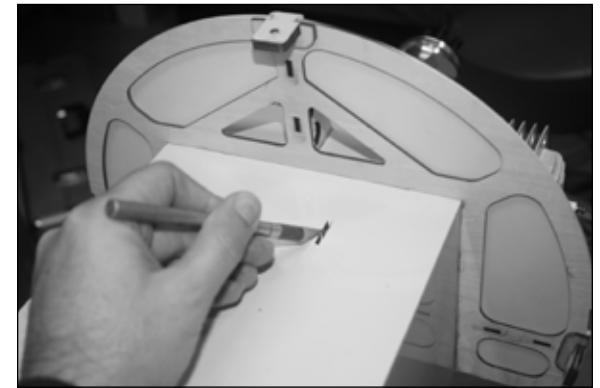

3. Iron down the edges and the covering on the engine box.



4. The ignition module and battery will be installed as one piece, on top of each other. Apply masking tape to both sides of battery and bottom side of ignition module.



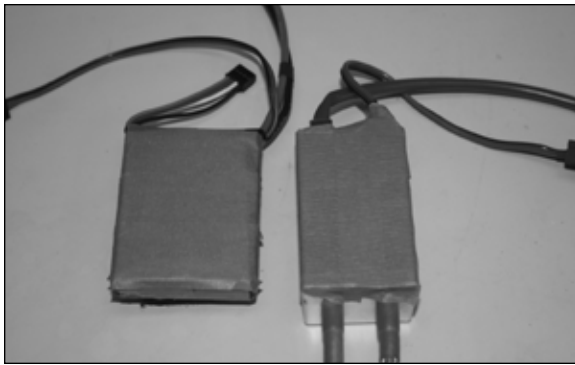

□ 5. Apply servo/double-sided tape between battery and ignition module.

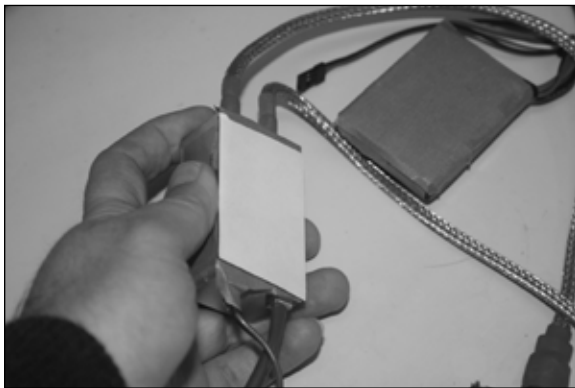

□ 6. Glue ¼-inch thick DuBro foam to the bottom of the battery using CA. Glue a piece of hook and loop to the foam.

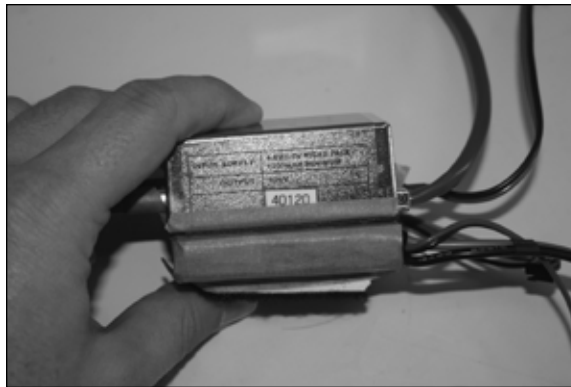

□ 7. Apply opposite side of adhesive-backed hook and loop to the engine box.



□ 8. Mount the ignition and battery as one piece and strap it with hook and loop straps. Provide an overlap of 2 inches for the strap to wrap around the battery and ignition module through the slots.

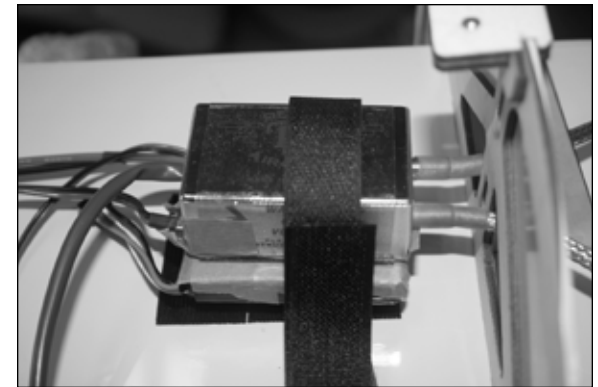

□ 9. Ignition will be mounted next to ignition module and battery. Glue a piece of hook and loop next to ignition module and battery.



□ 10. Apply a piece of masking tape to the bottom of regulator and glue opposite side of hook and loop using CA.



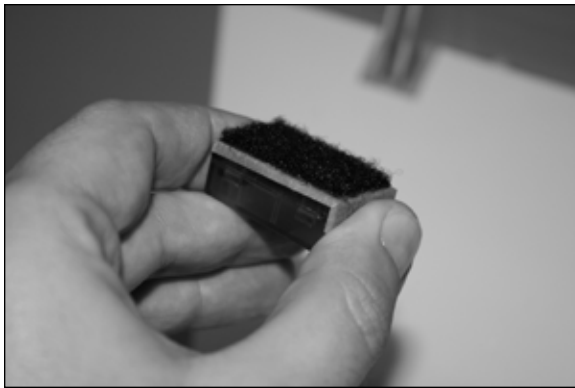

- 11. Mount the regulator.

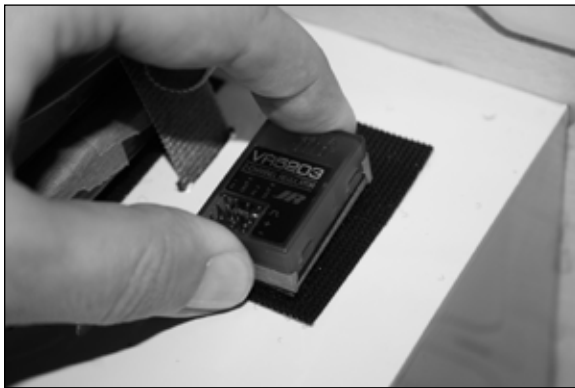

- 12. Use the excess strap from the ignition module and pull it over the ignition.

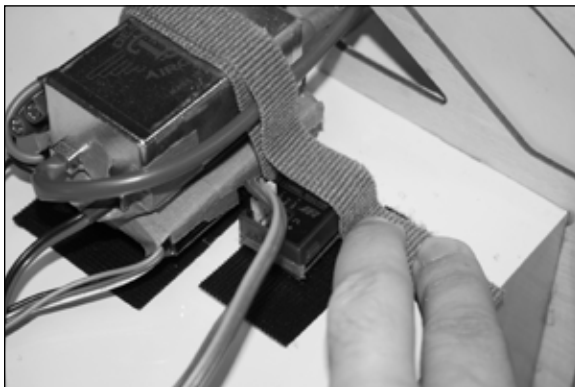

Note: Connect battery to switch, output of the switch to regulator (6-inch extension is needed) and regulator output to ignition. With this method, battery can be charged directly through the switch charge port.

## **Receiver Mount and Throttle Servo Regulator Installation**

### **Required Parts**

Receiver tray and stands      Fuselage

### **Required Parts (not included)**

JR 5203 regulator      Receiver

### **Required Tools and Adhesives**

Masking tape      CA thin and medium  
 CA accelerator      5-minute epoxy  
 Dubro 1/4-inch foam      Hook and loop  
 Hook and loop

- 1. Prepare the receiver to mount on the tray, similar to the ignition battery preparation in the previous section. Put two rounds of masking tape at the bottom of the receiver. Using CA glue 1/4-inch DuBro foam to the masking tape and glue a piece of hook and loop to the foam.



- 2. Glue opposite side of the hook and loop to the tray and mount the receiver.

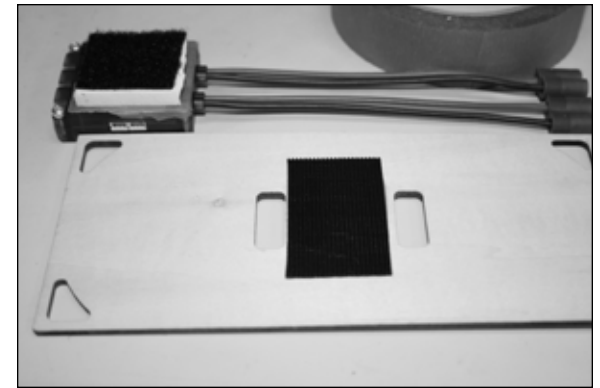

- 3. Throttle servo regulator is mounted next to the receiver using two pieces of hook and loop similar to step 1.

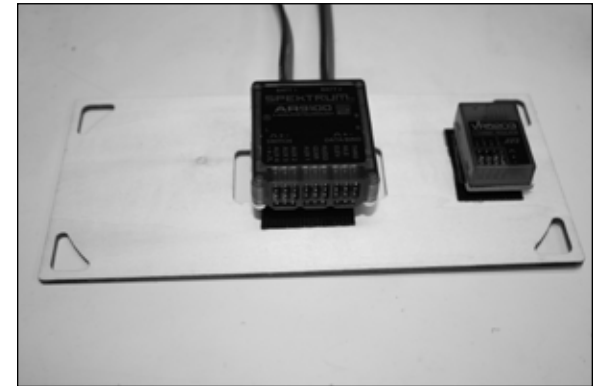

- 4. Glue balsa sticks using thin CA to the floor of the fuselage.





5. Glue the tray on the balsa stick using either Medium CA or 5-minute epoxy. Hold pressure on the tray until glue dries or epoxy sets.

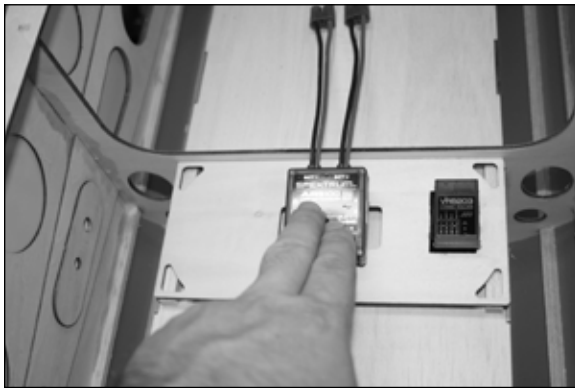

6. Strap the receiver using hook and loop.

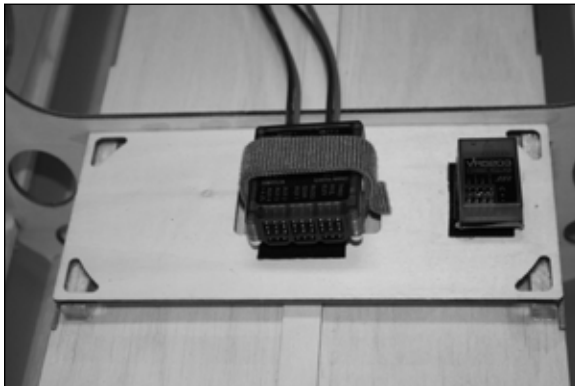

## Receiver Battery Installation

### Required Parts

Fuselage

### Required Parts (not included)

(2) Spektrum 4000 2-cell LiPo

(2) 12-inch EC3™ extensions

### Required Tools and Adhesives

Medium CA

Masking tape

Hook and loop

Hook and loop straps

1. Apply masking tape to the bottom of the batteries. Glue hook and loop using CA to the masking tape. Applying CA in addition to the adhesive already on the hook and loop ensures glue does not come undone on hot days.



2. Glue using CA opposite side of hook and loop to the sides of the fuselage as shown below.



3. Overlap 2 inches of hook and loop straps provided in

the kit and secure the batteries by passing the strips through the top and bottom slots.



The picture below shows the right battery setup.

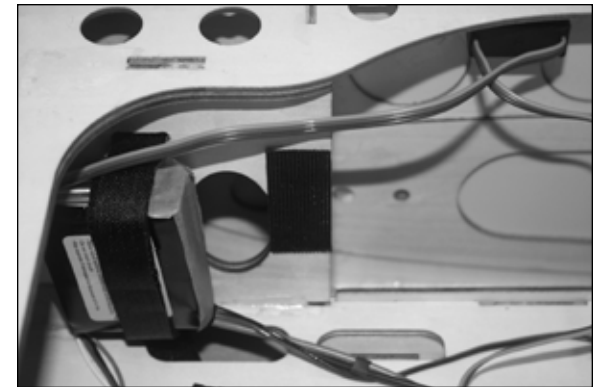

The picture below shows the left battery setup.



## Satellite Receiver and Receiver Switch Installation

### Required Parts

Fuselage

### Required Parts (not included)

(3 to 4) Satellite receivers

Receiver switch

### Required Tools and Adhesives

Double-sided tape

Masking tape

Hook and loop

Threadlock

Medium CA

Note: It is best to use 4 satellite receivers as this is a large model, however, with proper placement of the satellite receivers, 3 would be adequate. A Flight Log can help with correct placement of the satellite receivers. Check the health of the system before first flight.

1. Remove the covering from the right side of the fuselage and mount the receiver switch. Apply a small amount of threadlock to the screws.



2. There are two ways to mount the satellite receivers. One way is to simply apply a piece of double-sided/servo tape to the back of the satellite receiver and attach to the fuselage. See step 3 for the alternative method.

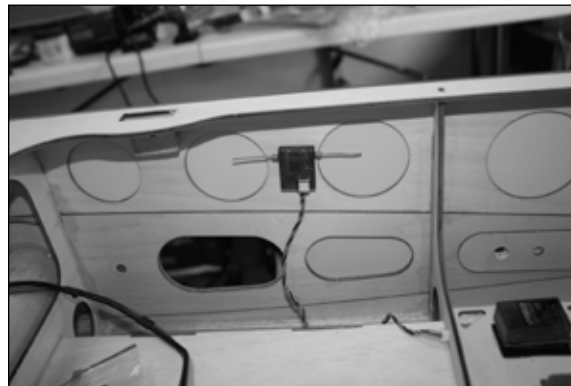
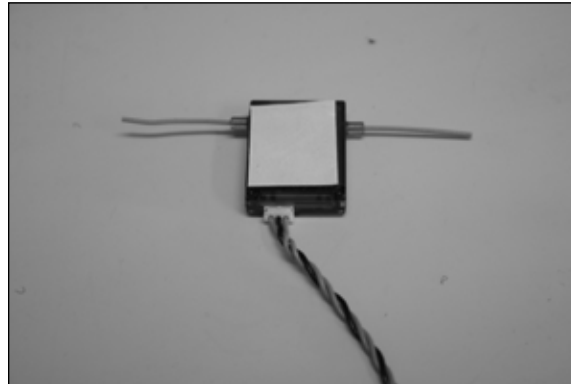
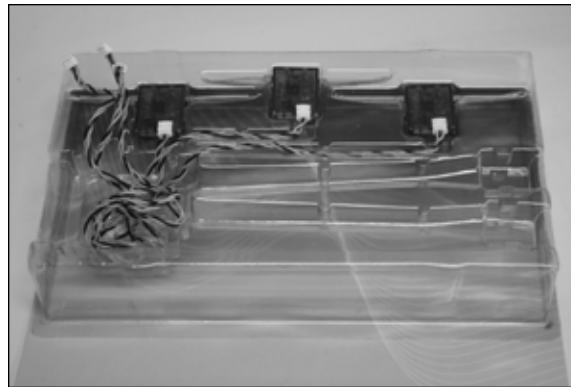

3. Attach a piece of masking tape to the back of the satellite receiver; apply a couple of drops of CA to the masking tape and stick a piece of hook and loop to the masking tape. Note that even if the hook and loop is adhesive-backed, CA helps hold the hook and loop to the masking tape in high temperatures.

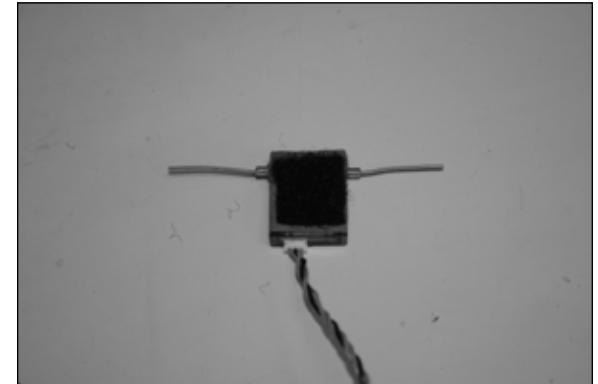

4. Using the same method glue the opposite side of the hook and loop to those parts of the fuselage where the satellite receivers will attach. Note the recommended locations in the following pictures.





## Pilot/Panel Assembly and Installation

### Required Parts

Pilot Pilot hardware

### Required Tools and Adhesives

3/32-inch ball driver Threadlock  
 Music wire, .050-inch (not included)  
 Flexible adhesive (Shoo Goo or Zap-A-Dap-A-Goo)  
 Foam-Safe CA

1. Pilot head comes in two pieces with two screws and washers. Apply threadlock to bolts and pass them through the lower body of the pilot through the head.



2. Glue the pilot using Shoo Goo to the place allocated in the canopy.



3. Locate the foam pilot panel and pilot panel decal.



## Center of Gravity

An important part of preparing the aircraft for flight is properly balancing the model.

**Caution: Do not inadvertently skip this step!**

The recommended Center of Gravity (CG) location for your model is 10.5 inches forward from the trailing edge of the wing tip as shown. Mark the location of the CG on the top of the wing with a felt-tipped pen.

Use help to lift the plane from the marked position.

For 3D flying 10 inches forward of trailing edge is recommended; however, the 10.5 inches is the best overall CG for both precision and 3D flying.

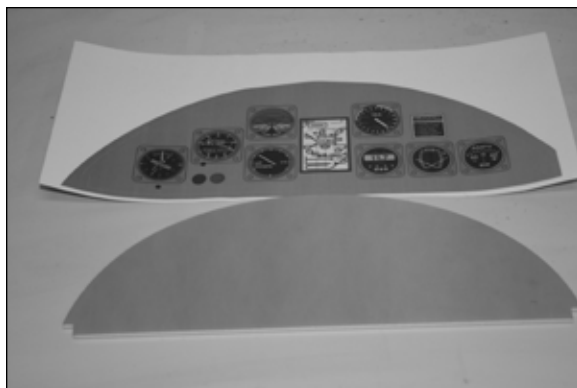

3. Peel the decal and stick to the foam pilot panel.



4. Glue the foam panel using foam-safe CA to the canopy.



5. Canopy bolts to the fuselage using 4 (4mm) screws provided.



After the first flights, the CG position can be adjusted for your personal preference.



## Applying Decals

Kit comes with decal sets and all decals are die-cut. All large decals should be applied wet so the bubbles can be worked out by squeegee. Allow 24 hours for decals to dry and adhesive to set.

It is important to take all the wrinkles in the covering out and would be best to apply the decals after the plane has been taken to a flying field a couple of times and all the wrinkles have been removed. The following pictures show the location of decals.



Wing Decal Close-up



## Applying Decals

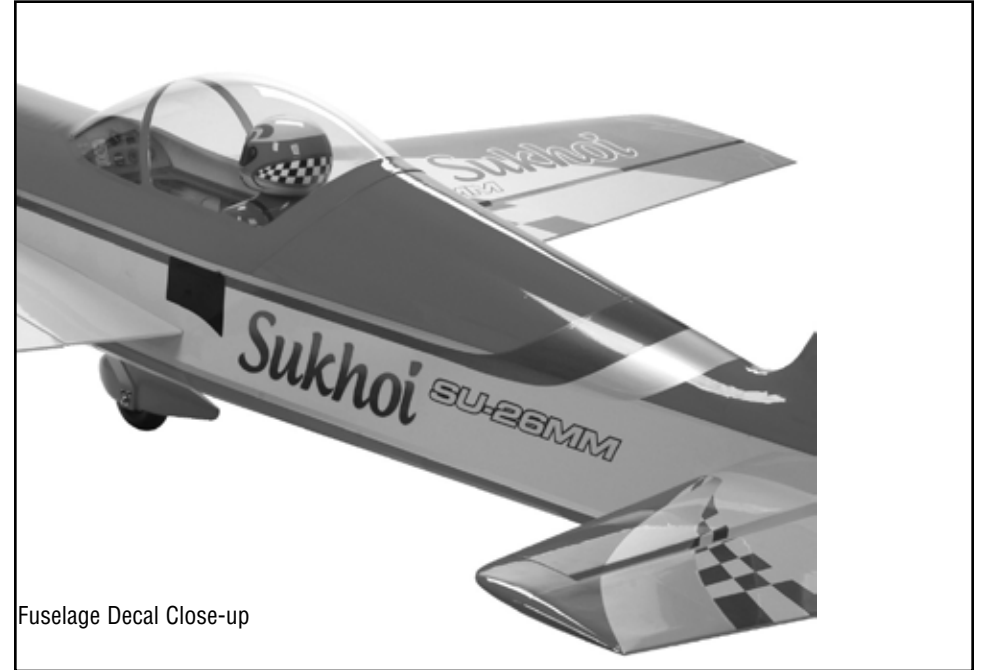
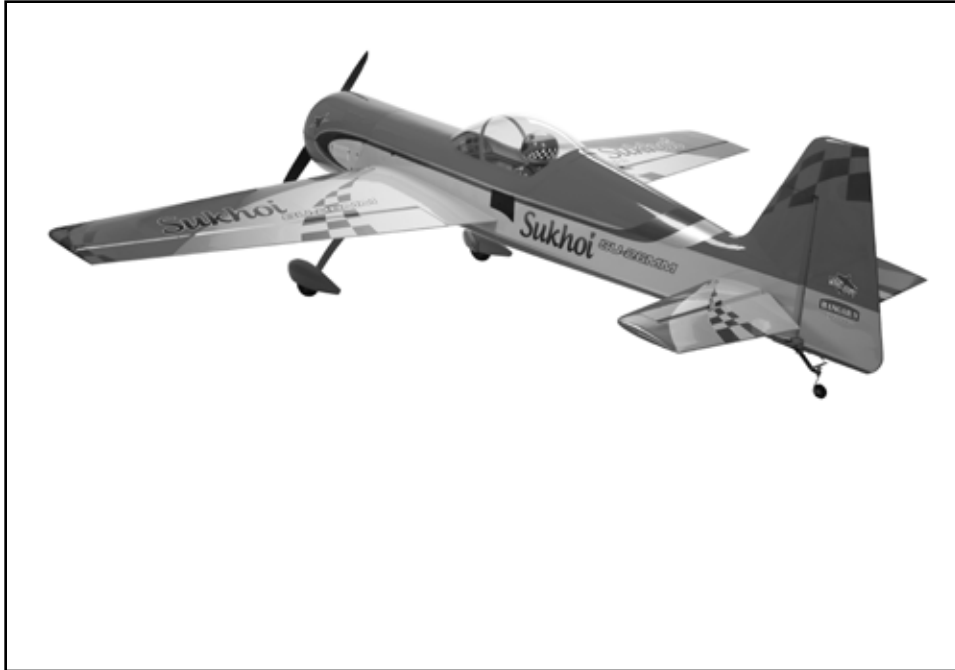

Fuselage Decal Close-up

## Control Throws

1. Turn on the transmitter and receiver of your model. Check the movement of the rudder using the transmitter. When the stick is moved right, the rudder should also move right. Reverse the direction of the servo at the transmitter if necessary.

2. Check the movement of the elevator with the radio system. Moving the elevator stick toward the bottom of the transmitter will make the airplane elevator move up.

3. Check the movement of the ailerons with the radio system. Moving the aileron stick right will make the right aileron move up and the left aileron move down.

4. Use a throw meter to adjust the throw of the elevator, ailerons and rudder.

Mike McConville has three flight modes as follows:

1. Normal: This flight mode is used for most precision maneuvers.

2. Roller: This flight mode is used for spins, hammer head and rolling circles. It has more rudder and elevator compared to Normal flight mode.

3. High (3D): All surfaces at full deflection for 3D flying.

Mike's plane uses 1% down elevator mix to throttle for down lines and 5% up elevator to eliminate the pitch coupling in knife edge. Please note this is very C.G dependant.

See Pro-Tips section for more details.

### Elevator:

<i>High Rate:</i>	<i>Expo</i>
Up: 43 degrees	70%
Down: 43 degrees	70%

<i>Roller:</i>	<i>Expo</i>	
Up: 14.5 degrees	42%	See Pro-Tips
Down: 14.5 degrees	42%	

<i>Normal:</i>	<i>Expo</i>
Up: 10.5 degrees	42%
Down: 10.5 degrees	42%

### Aileron:

<i>High Rate:</i>	<i>Expo</i>
Up: 34 degrees	45%
Down: 33 degrees	45%

<i>Roller Rate:</i>	<i>Expo</i>
Up: 25.5 degrees	46%
Down: 25 degrees	46%

<i>Normal Rate:</i>	<i>Expo</i>
Up: 28.5 degrees	45%
Down: 28 degrees	45%

### Rudder:

<i>High and Roller Rate:</i>	<i>Expo</i>
Right: 40 degrees	56%
Left: 40 degrees	56%

<i>Normal Rate:</i>	
Right: 23 degrees	45%
Left: 23 degrees	45%

These are general guidelines measured from our own flight tests. You can experiment with higher rates to match your preferred style of flying.

**Note:** Travel Adjust, Sub-Trim and Dual Rates are not listed and should be adjusted according to each individual model and preference.

## Pro-Tips

Important mixes that should be done correctly for precision flying are as follows; this is besides the pitch coupling mixes.

1. Downline Mix: Mike McConville's plane needs only 1% of down elevator that comes on at low end of idle. It is important that this is done correctly to avoid inadvertent down elevator when it is not needed.



2. For roller flight mode, Mike uses an elevator to elevator mix that allows the elevator feel around center stick to be the same as normal flight mode and increases elevator throw at the extreme stick movement for spins and other maneuvers that need extra elevator deflection. This is without compromising the precision feel of the elevator.



## ***Preflight***

---

### **Check Your Radio**

Before going to the field, be sure your batteries are fully charged per your radio's instructions. Charge the transmitter and motor battery for your airplane. Use the recommended charger supplied with your particular radio system, following the instructions provided with the radio. In most cases, the radio should be charged the night before going out flying.

Before each flying session, be sure to range check your radio. See your radio manual for the recommended range and instructions for your radio system. Each radio manufacturer specifies different procedures for their radio systems. Next, run the motor. With the model securely anchored, check the range again. The range test should not be significantly affected. If it is, don't attempt to fly! Have your radio equipment checked out by the manufacturer.

Double-check that all controls (aileron, elevator, rudder and throttle) move in the correct direction.

Check the radio installation and make sure all the control surfaces are moving correctly (i.e., the correct direction and with the recommended throws).

Check all the control horns, servo horns, and clevises to make sure they are secure and in good condition.

### ***Range Test Your Radio***

---

Before each flying session, and especially with a new model, it is important to perform a range check. It is helpful to have another person available to assist during the range check. If you are using a Spektrum transmitter, please refer to your transmitter's manual for detailed instructions on the range check process.

## ***Safety Do's and Don'ts for Pilots***

---

- Consult local laws and ordinances before choosing a location to fly your aircraft.
- Check all control surfaces prior to each takeoff.
- Do not fly your model near spectators, parking areas or any other area that could result in injury to people or damage of property.
- Do not fly during adverse weather conditions. Poor visibility can cause disorientation and loss of control of your aircraft. Strong winds can cause similar problems.
- Do not take chances. If at any time during flight you observe any erratic or abnormal operation, land immediately and do not resume flight until the cause of the problem has been ascertained and corrected. Safety can never be taken lightly.
- Do not fly near power lines.

### ***Daily Flight Checks***

---

1. Check the battery voltage of the transmitter battery. Do not fly below the manufacturer's recommended voltage. To do so can crash your aircraft.

**When you check these batteries, ensure you have the polarities correct on your expanded scale voltmeter.**

2. Check all hardware (linkages, screws, nuts, and bolts) prior to each day's flight. Be sure that binding does not occur and that all parts are properly secured.
3. Ensure all surfaces are moving in the proper manner.
4. Perform a ground range check before each day's flying session.
5. Prior to starting your aircraft, turn off your transmitter, then turn it back on. Do this each time you start your aircraft. If any critical switches are on without your knowledge, the transmitter alarm will sound a warning at this time.
6. Check that all trim levers are in the proper location.
7. All servo pigtailed and switch harness plugs should be secured in the receiver. Make sure the switch harness moves freely in both directions.

## Warranty and Repair Policy

### WARRANTY PERIOD

Exclusive Warranty- Horizon Hobby, Inc., (Horizon) warrants that the Products purchased (the "Product") will be free from defects in materials and workmanship at the date of purchase by the Purchaser.

### LIMITED WARRANTY

**Horizon reserves the right to change or modify this warranty without notice and disclaims all other warranties, express or implied.**

(a) This warranty is limited to the original Purchaser ("Purchaser") and is not transferable. REPAIR OR REPLACEMENT AS PROVIDED UNDER THIS WARRANTY IS THE EXCLUSIVE REMEDY OF THE PURCHASER. This warranty covers only those Products purchased from an authorized Horizon dealer. Third party transactions are not covered by this warranty. Proof of purchase is required for all warranty claims.

(b) Limitations- HORIZON MAKES NO WARRANTY OR REPRESENTATION, EXPRESS OR IMPLIED, ABOUT NON-INFRINGEMENT, MERCHANTABILITY OR FITNESS FOR A PARTICULAR PURPOSE OF THE PRODUCT. THE PURCHASER ACKNOWLEDGES THAT THEY ALONE HAVE DETERMINED THAT THE PRODUCT WILL SUITABLY MEET THE REQUIREMENTS OF THE PURCHASER'S INTENDED USE.

(c) Purchaser Remedy- Horizon's sole obligation hereunder shall be that Horizon will, at its option, (i) repair or (ii) replace, any Product determined by Horizon to be defective. In the event of a defect, these are the Purchaser's exclusive remedies. Horizon reserves the right to inspect any and all equipment involved in a warranty claim. Repair or replacement decisions are at the sole discretion of Horizon. This warranty does not cover cosmetic damage or damage due to acts of God, accident, misuse, abuse, negligence, commercial use, or modification of or to any part of the Product. This warranty does not cover damage due to improper installation, operation, maintenance, or attempted repair by anyone other than Horizon. Return of any Product by Purchaser must be approved in writing by Horizon before shipment.

### DAMAGE LIMITS

HORIZON SHALL NOT BE LIABLE FOR SPECIAL, INDIRECT OR CONSEQUENTIAL DAMAGES, LOSS OF PROFITS OR PRODUCTION OR COMMERCIAL LOSS IN ANY WAY CONNECTED WITH THE PRODUCT, WHETHER SUCH CLAIM IS BASED IN CONTRACT, WARRANTY, NEGLIGENCE, OR STRICT LIABILITY. Further, in no event shall the liability of Horizon exceed the individual price of the Product on which liability is asserted. As Horizon has no control over use, setup, final assembly, modification or misuse, no liability shall be assumed nor accepted for any resulting damage or injury. By the act of use, setup or assembly, the user accepts all resulting liability.

If you as the Purchaser or user are not prepared to accept the liability associated with the use of this Product, you are advised to return this Product immediately in new and unused condition to the place of purchase.

Law: These Terms are governed by Illinois law (without regard to conflict of law principals).

## Warranty Services

### QUESTIONS, ASSISTANCE, AND REPAIRS

Your local hobby store and/or place of purchase cannot provide warranty support or repair. Once assembly, setup or use of the Product has been started, you must contact Horizon directly. This will enable Horizon to better answer your questions and service you in the event that you may need any assistance. For questions or assistance, please direct your email to [productsupport@horizonhobby.com](mailto:productsupport@horizonhobby.com), or call 877.504.0233 toll free to speak to a Product Support representative. You may also find information on our website at [www.horizonhobby.com](http://www.horizonhobby.com).

### INSPECTION OR REPAIRS

If this Product needs to be inspected or repaired, please use the Horizon Online Repair Request submission process found on our website or call Horizon to obtain a Return Merchandise Authorization (RMA) number. Pack the Product securely using a shipping carton. Please note that original boxes may be included, but are not designed to withstand the rigors of shipping without additional protection. Ship via a carrier that provides tracking and insurance for lost or damaged parcels, as Horizon is not responsible for merchandise until it arrives and is accepted at our facility. An Online Repair Request is available at <http://www.horizonhobby.com> under the Repairs tab. If you do not have internet access, please contact Horizon Product Support to obtain a RMA number along with instructions for submitting your product for repair. When calling Horizon, you will be asked to provide your complete name, street address, email address and phone number where you can be reached during business hours. When sending product into Horizon, please include your RMA number, a list of the included items, and a brief summary of the problem. A copy of your original sales receipt must be included for warranty consideration. Be sure your name, address, and RMA number are clearly written on the outside of the shipping carton.

**Notice: Do not ship batteries to Horizon. If you have any issue with a battery, please contact the appropriate Horizon Product Support office.**



## **WARRANTY INSPECTION AND REPAIRS**

To receive warranty service, you must include your original sales receipt verifying the proof-of-purchase date. Provided warranty conditions have been met, your Product will be repaired or replaced free of charge. Repair or replacement decisions are at the sole discretion of Horizon.

## **NON-WARRANTY REPAIRS**

Should your repair not be covered by warranty the repair will be completed and payment will be required without notification or estimate of the expense unless the expense exceeds 50% of the retail purchase cost. By submitting the item for repair you are agreeing to payment of the repair without notification. Repair estimates are available upon request. You must include this request with your repair. Non-warranty repair estimates will be billed a minimum of ½ hour of labor. In addition you will be billed for return freight. Horizon accepts money orders and cashiers checks, as well as Visa, MasterCard, American Express, and Discover cards. By submitting any item to Horizon for inspection or repair, you are agreeing to Horizon's Terms and Conditions found on our website under the Repairs tab.

Please note: non-warranty repair is only available on electronics and model engines.

### **United States:**

Electronics and engines requiring inspection or repair should be shipped to the following address:

Horizon Service Center  
4105 Fieldstone Road  
Champaign, Illinois 61822  
USA

All other Products requiring warranty inspection or repair should be shipped to the following address:

Horizon Product Support  
4105 Fieldstone Road  
Champaign, Illinois 61822  
USA

Please call 877-504-0233 or e-mail us at [productsupport@horizonhobby.com](mailto:productsupport@horizonhobby.com) with any questions or concerns regarding this product or warranty.

### **United Kingdom:**

Electronics and engines requiring inspection or repair should be shipped to the following address:

Horizon Hobby Limited  
Units 1-4 Ployters Rd  
Staple Tye  
Harlow, Essex  
CM18 7NS  
United Kingdom

Please call +44 (0) 1279 641 097 or e-mail us at [sales@horizonhobby.co.uk](mailto:sales@horizonhobby.co.uk) with any questions or concerns regarding this product or warranty.

### **Germany:**

Electronics and engines requiring inspection or repair should be shipped to the following address:

Horizon Technischer Service  
Hamburger Strasse 10  
25335 Elmshorn  
Germany

Please call +49 4121 46199 66 or e-mail us at [service@horizonhobby.de](mailto:service@horizonhobby.de) with any questions or concerns regarding this product or warranty.

### **France:**

Horizon Hobby SAS  
14 Rue Gustave Eiffel  
Zone d'Activité du  
Réveil Matin  
91230 Montgeron

Please call +33 (0) 1 60 47 44 70 with any questions or concerns regarding this product or warranty.

## **Compliance Information for the European Union**



### **INSTRUCTIONS FOR DISPOSAL OF WEEE BY USERS IN THE EUROPEAN UNION**

This product must not be disposed of with other waste. Instead, it is the user's responsibility to dispose of their waste equipment by handing it over to a designated collection point for the recycling of waste electrical and electronic equipment. The separate collection and recycling of your waste equipment at the time of disposal will help to conserve natural resources and ensure that it is recycled in a manner that protects human health and the environment. For more information about where you can drop off your waste equipment for recycling, please contact your local city office, your household waste disposal service or where you purchased the product.

# 2010 Official Academy of Model Aeronautics Safety Code

## GENERAL

1. A model aircraft shall be defined as a non-human-carrying device capable of sustained flight in the atmosphere. It shall not exceed limitations established in this code and is intended to be used exclusively for recreational or competition activity.
2. The maximum takeoff weight of a model aircraft, including fuel, is 55 pounds, except for those flown under the AMA Experimental Aircraft Rules.
3. I will abide by this Safety Code and all rules established for the flying site I use. I will not willfully fly my model aircraft in a reckless and/or dangerous manner.
4. I will not fly my model aircraft in sanctioned events, air shows, or model demonstrations until it has been proven airworthy.
5. I will not fly my model aircraft higher than approximately 400 feet above ground level, when within three (3) miles of an airport without notifying the airport operator. I will yield the right-of-way and avoid flying in the proximity of full-scale aircraft, utilizing a spotter when appropriate.
6. I will not fly my model aircraft unless it is identified with my name and address, or AMA number, inside or affixed to the outside of the model aircraft. This does not apply to model aircraft flown indoors.
7. I will not operate model aircraft with metal-blade propellers or with gaseous boosts (other than air), nor will I operate model aircraft with fuels containing tetranitromethane or hydrazine.

8. I will not operate model aircraft carrying pyrotechnic devices which explode burn, or propel a projectile of any kind. Exceptions include Free Flight fuses or devices that burn producing smoke and are securely attached to the model aircraft during flight. Rocket motors up to a G-series size may be used, provided they remain firmly attached to the model aircraft during flight. Model rockets may be flown in accordance with the National Model Rocketry Safety Code; however, they may not be launched from model aircraft. Officially designated AMA Air Show Teams (AST) are authorized to use devices and practices as defined within the Air Show Advisory Committee Document.
9. I will not operate my model aircraft while under the influence of alcohol or within eight (8) hours of having consumed alcohol.
10. I will not operate my model aircraft while using any drug which could adversely affect my ability to safely control my model aircraft.
11. Children under six (6) years old are only allowed on a flightline or in a flight area as a pilot or while under flight instruction.
12. When and where required by rule, helmets must be properly worn and fastened. They must be OSHA, DOT, ANSI, SNELL or NOCSAE approved or comply with comparable standards.

## RADIO CONTROL

1. All model flying shall be conducted in a manner to avoid over flight of unprotected people.
2. I will have completed a successful radio equipment ground-range check before the first flight of a new or repaired model aircraft.
3. I will not fly my model aircraft in the presence of spectators until I become a proficient flier, unless I am assisted by an experienced pilot.
4. At all flying sites a line must be established, in front of which all flying takes place. Only personnel associated with flying the model aircraft are allowed at or in front of the line. In the case of airshows demonstrations straight line must be established. An area away from the line must be maintained for spectators. Intentional flying behind the line is prohibited.

5. I will operate my model aircraft using only radio-control frequencies currently allowed by the Federal Communications Commission (FCC). Only individuals properly licensed by the FCC are authorized to operate equipment on Amateur Band frequencies.
6. I will not knowingly operate my model aircraft within three (3) miles of any preexisting flying site without a frequency-management agreement. A frequency management agreement may be an allocation of frequencies for each site, a day-use agreement between sites, or testing which determines that no interference exists. A frequency-management agreement may exist between two or more AMA chartered clubs, AMA clubs and individual AMA members, or individual AMA members. Frequency-management agreements, including an interference test report if the agreement indicates no interference exists, will be signed by all parties and copies provided to AMA Headquarters.
7. With the exception of events flown under official AMA rules, no powered model may be flown outdoors closer than 25 feet to any individual, except for the pilot and located at the flightline.
8. Under no circumstances may a pilot or other person touch a model aircraft in flight while it is still under power, except to divert it from striking an individual.
9. Radio-controlled night flying is limited to low-performance model aircraft (less than 100 mph). The model aircraft must be equipped with a lighting system which clearly defines the aircraft's attitude and direction at all times.
10. The operator of a radio-controlled model aircraft shall control it during the entire flight, maintaining visual contact without enhancement other than by corrective lenses that are prescribed for the pilot. No model aircraft shall be equipped with devices which allow it to be flown to a selected location which is beyond the visual range of the pilot.



*Fly First Class™*



© 2011 Horizon Hobby, Inc.  
horizonhobby.com  
Hangar9.com