

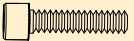

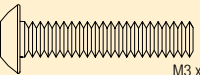





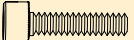
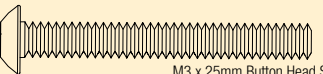
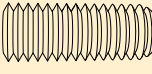

FASTENERS // VERBINDUNGSELEMENTE // VISSERIES // ELEMENTI DI FISSAGGIO //////////////////////////////////////

 <p>x 8 M2 x 10mm Cap Head Screw M2 x 10mm Innensechskantschrauben Vis à tête creuse M2 x 10mm Viti a testa bombata M2 x 10mm VTR235005</p>	 <p>x 12 M3 x 14mm Button Head Screw M3 x 14mm Halbrundsrauben Vis à tête bombée M3 x 14mm Viti testa tonda M3 x 14mm VTR235109</p>	 <p>x 2 M3 x 3mm Cup Point Set Screw M3 x 3mm Ringschneide Gewindestift Vis Imbus à bout cuvette M3 x 3mm Tazza punto grani M3 x 3mm VTR235320</p>	 <p>x 2 3.2mm x 7mm x .5mm Washer 3,2mm x 7mm x ,5mm Unterlegscheiben Rondelle 3,2mm x 7mm x ,5mm Rondella 3,2mm x 7mm x ,5mm VTR236076</p>
 <p>x 1 M2.5 x 10mm Cap Head Screw M2.5 x 10mm Innensechskantschrauben Vis à tête creuse M2,5 x 10mm Viti a testa bombata M2,5 x 10mm VTR235014</p>	 <p>x 2 M3 x 25mm Button Head Screw M3 x 25mm Halbrundsrauben Vis à tête bombée M3 x 25mm Viti testa tonda M3 x 25mm VTR235113</p>	 <p>x 4 M4 x 10mm Cup Point Set Screw M4 x 10mm Ringschneide Gewindestift Vis Imbus à bout cuvette M4 x 10mm Tazza punto grani M4 x 10mm VTR235347</p>	 <p>x 10 5mm x 10mm x 4mm Ball Bearing 5mm x 10mm x 4mm Kugellager Roulement 5mm x 10mm x 4mm Cuscinetto a sfere 5mm x 10mm x 4mm VTR237004</p>
 <p>x 10 M2.8 x 10mm Cap Head Screw M2,8 x 10mm Innensechskantschrauben Vis à tête creuse M2,8 x 10mm Viti a testa bombata M2,8 x 10mm VTR235222</p>	 <p>x 10 M2.5 x 4mm Button Head Screw M2,5 x 4mm Halbrundsrauben Vis à tête bombée M2,5 x 4mm Viti testa tonda M2,5 x 4mm VTR235095</p>	 <p>x 4 M3 Nylock Nut M3 Mutter Nylock Écrou Nylock M3 Dado Nylock M3 VTR236014</p>	 <p>x 10 8mm x 12mm x 3.5mm Ball Bearing 8mm x 12mm x 3,5mm Kugellager Roulement 8mm x 12mm x 4mm Cuscinetto a sfere 5mm x 10mm x 4mm VTR237019</p>
 <p>x 2 M3 x 8mm Cap Head Screw M3 x 8mm Innensechskantschrauben Vis à tête creuse M3 x 8mm Viti a testa bombata M3 x 8mm VTR235025</p>	 <p>x 29 M3 x 10mm Flat Head Screw M3 x 10mm Flachkopfschrauben Vis à tête fraisée M3 x 10mm Viti a testa piatta M3 x 10mm VTR235176</p>	 <p>x 4 M4 Nylock Flanged Nut M4 Mutter Nylock angeflanscht Écrou Nylock bride M4 Dado Nylock flangiato M4 VTR236025</p>	 <p>x 4 12mm x 18mm x 4mm Ball Bearing 12mm x 18mm x 4mm Kugellager Roulement 12mm x 18mm x 4mm Cuscinetto a sfere 12mm x 18mm x 4mm VTR237029</p>
 <p>x 4 M3 x 10mm Cap Head Screw M3 x 10mm Innensechskantschrauben Vis à tête creuse M3 x 10mm Viti a testa bombata M3 x 10mm VTR235107</p>	 <p>x 26 M3 x 14mm Flat Head Screw M3 x 14mm Flachkopfschrauben Vis à tête fraisée M3 x 14mm Viti a testa piatta M3 x 14mm VTR235178</p>		

REPLACEMENT PARTS // ERSATZTEILE // PIÈCES DE RECHANGE // PEZZI DI RICAMBIO //

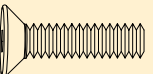
Part # Nummer Numéro Codice	Description	Beschreibung	Description	Descrizione
DYN1050EC	Speedpack™ 1800mAh 6-Cell Flat with EC3™ Connector	Dynamite Speedpack 1800mAh NiMH 6-Zellen Flat mit EC3 Stecker	Batterie Ni-Mh Speedpack 7.2V 1800mA avec prise EC3	Speedpack 1800mAh 6-celle piatto con connettore EC3
DYN1172	Dynamite 15-Turn Brushed Motor	Dynamite 15-Turn Bürstenmotor	Moteur Dynamite 15T à balais	Dynamite 15-spire motore con spazzole
DYN4113	2A Ni-MH AC Charger	Dynamite 2A NiMH AC Peak Ladegerät - EU	Chargeur AC rapide 2A	Caricatore 2A Ni-MH AC
DYNS2210	Dynamite 12T ESC	Dynamite 12T ESC	Dynamite 12T ESC	Dynamite 12T ESC
SPM2322	DX2E 2-Channel DSM Surface Radio	Spektrum DX2E Set Sender mit Empfänger	Radio 2 voies DX2E DSM	Radio per auto DX2E 2-canali DSM
SPMSR200WP	SR200WP 2 Channel Waterproof Receiver	Spektrum SR200WP 2K DSM Sport Empfänger Wassergeschützt	Récepteur 2 voies étanche SR200WP DSM	Ricevitore impermeabile SR200WP 2 canali
SPMSS6170	S6170 Std. Digital Servo	S6170 Std. Digital Servo	S6170 Std. Servo digital	S6170 Std. Servo digitale

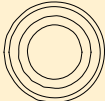
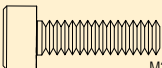
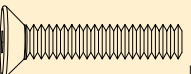
SHOCK ASSEMBLY // STOSSDÄMPFER // ASSEMBLAGE DES AMORTISSEURS // GRUPPO AMMORTIZZATORI //

Part # Nummer Numéro Codice	Description	Beschreibung	Description	Descrizione
VTR233007	Shock Body Set	Dämpfergehäuseset	Jeu de corps d'amortisseurs	Set corpo ammortizzatore
VTR233009	Shock Spring Medium Silver	Feder Silber/Mittel	Ressort d'amortisseur moyen, argent (2)	Molla ammortizzatore media argento



FRONT BUMPER // FRONTSTOSSSTANGE // PARE-CHOC AVANT // PARAUTI ANTERIORE //////////////////////////////////////

Part # Nummer Numéro Codice	Description	Beschreibung	Description	Descrizione
VTR230006	Body Post Set	Karosseriehalter Set	Set de supports de carrosserie	Set supporti carrozzeria
VTR231012	Bumper Set Front	Stoßfängerset Vorne	Pare-choc avant	Set paraurti anteriore

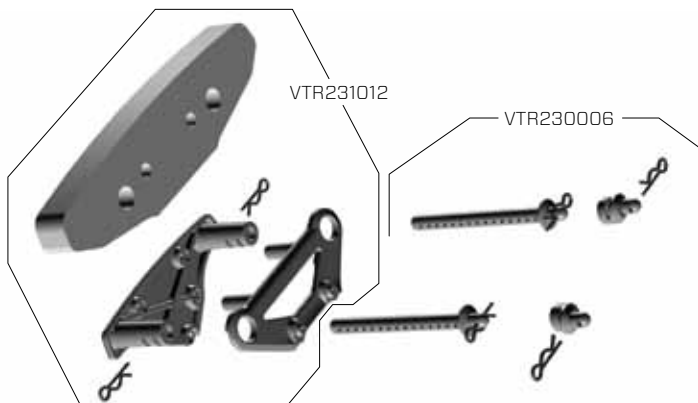

MOTOR PLATE // MOTORMONTAGEPLATTE // SUPPORT MOTEUR // PIASTRA MOTORE //////////////////////////////////////

Part # Nummer Numéro Codice	Description	Beschreibung	Description	Descrizione
VTR232044	Spur Gear, 77T, 48P	Hauptzahnrad 77Z 48P	Couronne 77T, 48P	Corona, 77T, 48P
VTR232050	Gear Cover Motor Plate Heat Shield Set	Getriebebeschutzhülse und Motormontageplatte	Set de protection de transmission et de refroidisseur moteur	Piastra motore copertura ingranaggi e protezione calore



FRONT SUSPENSION // FRONT AUFHÄNGUNG // SUSPENSION AVANT // SOSPENSIONE ANTERIORE //////////////////////////////////////

Part # Nummer Numéro Codice	Description	Beschreibung	Description	Descrizione
VTR43003	Wheel FR Deep Mesh 54x26mm Chrome/Blk (2)	Felge Vorne Deep Mesh 54x26mm Schwarz/Chrom 2st.	Jante nid d'abeille à déport AV 54x26mm, chrome foncé (2)	Cerchio ruota FR 54x26mm Nero cromato (2)
VTR43011	Tire 67x26mm V1 Performance S Compound (2)	Reifen 67x26mm V1 Performance Weich (2)	Pneu V1 performance S Compound 67x26mm (2)	Gomma 67x26mm V1 Performance S Compound (2)
VTR232042	Axle Shaft Set FR/RR (2)	Radachsen Set Vorne/Hinten	Jeu d'axes de roues AV/ARR (2)	Set albero asse FR/RR (2)
VTR232051	Wheel Hex Brake Rotor & Caliper FR/RR Set	Scheibenbremse mit Bremsattel Vorne/Hinten	Jeu d'hexagones de roues avec disque et étrier de frein AV/ARR	Set pinza e disco freno FR/RR
VTR234014	Suspension Arm Set FR/RR Upper & Lower	Querlenker set Vorne/Hinten	Jeu de bras de suspension inférieur et supérieur AV/ARR	Set bracci sospensioni FR/RR super. infer.
VTR234015	Front Upright Set LH/RH	Achsschenkel set Vorne L/R	Jeu de fusées avant	Set anteriore superiore LH/RH



REAR SUSPENSION // HECK AUFHÄNGUNG // SUSPENSION ARRIÈRE // SOSPENSIONE POSTERIORE //////////////////////////////////////

Part # Nummer Numéro Codice	Description	Beschreibung	Description	Descrizione
VTR43004	Wheel RR Deep Mesh 54x30mm Chrome/Bik (2)	Felge Hinten Deep Mesh 54x30mm Schwarz/Chrom 2st.	Jante nid d'abeille à déport ARR 54x30mm, chrome foncé (2)	Cerchio ruota RR 54x30mm Nero cromato (2)
VTR43012	Tire 67x30mm V1 Performance S Compound (2)	Reifen 67x30mm V1 Performance Weich (2)	Pneu V1 performance S Compound 67x30mm (2)	Gomme 67x30mm V1 Performance S Compound (2)
VTR232042	Axle Shaft Set FR/RR (2)	Radachsen Set Vorne/Hinten	Jeu d'axes de roues AV/ARR (2)	Set alberino asse FR/RR (2)
VTR234014	Suspension Arm Set FR/RR Upper & Lower	Querlenker Set Vorne/Hinten	Jeu de bras de suspension inférieur et supérieur AV/ARR	Set bracci sospensioni FR/RR super. infer.
VTR234015	Front Upright Set LH/RH	Achsschenkelset Vorne L/R	Jeu de fusées arrières	Set anteriore superiore LH/RH
VTR235226	M3 x 28mm Button Head Outer Hinge Pin Screw	Rundkopfstiftschraube Hinge Pin Außen M3x28mm	Vis/axe de suspension extérieur M3x28mm	M3 x 28mm Vite a testa bombata



FRONT CLIP // FRONTCLIP // CELLULE AVANT // CLIP ANTERIORE

Part # Nummer Numéro Codice	Description	Beschreibung	Description	Descrizione
VTR231007	Steering Servo Saver Set & Servo Mounts	Servosaver und Servobefestigung	Sauve servo et supports de servo	Set salva servo sterzo & supporti servo
VTR231008	Steering Bell Crank Set	Umlenkset für Lenkung	Jeu de renvois de direction	Set squadrette sterzo
VTR232040	Gear Box Upper Lower Set	Getriebekasten Set	Carter de transmission supérieur et inférieur	Set scatola riduttore sup. infer.
VTR232042	Axle Shaft Set FR/RR (2)	Radachsen Set Vorne/Hinteten	Jeu d'axes de roues AV/ARR (2)	Set alberino asse FR/RR (2)
VTR232047	Diff Outdrive Cup Set FR/RR	Antriebsklauenset Vorne/Hinten	Jeu de noix de sortie de différentiel AV/ARR	Set trascinatori diff. FR/RR
VTR232049	Complete Differential Set FR/RR	Diff Komplettsset Vorne/Hinten	Différentiel complet AV/ARR	Set differenziale completo FR/RR
VTR234013	Suspension Pivot Balls & Washer Set	Pivotkugel und Scheibenset	Jeu de rondelles et de rotules de suspension	Set rondelle a attacchi a sfera sospensioni
VTR234017	Upper Suspension Arm Mount FR/RR	Querlenkerhalter Vorne/Hinten	Support de bras de suspension supérieurs AV/ARR	Supporto braccio super. sospensioni FR/RR
VTR234018	Shock Tower Set FR/RR	Dämpferbrücke	Jeu de supports d'amortisseurs AV/ARR	Set torre ammortizzatori FR/RR
VTR235225	M3 x38mm Button Head Inner Hinge Pin Screw	Rundkopfstiftschraube Hinge Pin Innen M3x38mm	Vis/axe de suspension intérieur M3x38mm	M3 x38mm Vite a testa bombata

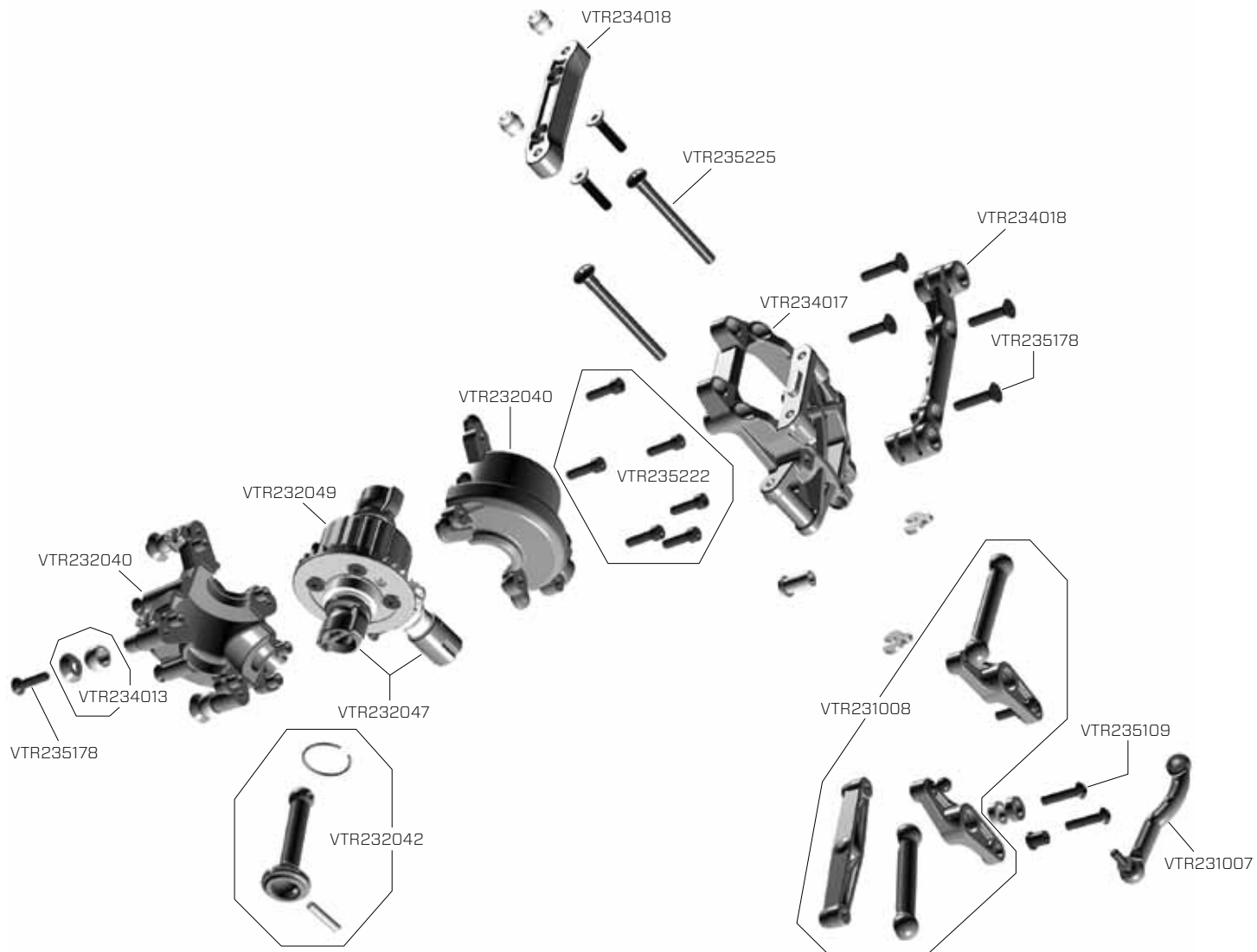

REAR CLIP // HECKCLIP // CELLULE ARRIERE // CLIP POSTERIORE //////////////////////////////////////

Part # Nummer Numéro Codice	Description	Beschreibung	Description	Descrizione
VTR230006	Body Post Set	Karosseriehalter	Set de supports de carrosserie	Set supporti carrozzeria
VTR232040	Gear Box Upper Lower Set	Getriebekasten Set	Carter de transmission supérieur et inférieur	Set scatola riduttore sup. infer.
VTR232042	Axle Shaft Set FR/RR (2)	Radachsen Set Vorne/Hinten	Jeu d'axes de roues AV/ARR (2)	Set albero asse FR/RR (2)
VTR232043	Diff Ring/Pinion 32T/12T FR/RR	Kegelrad und Triebbling 32Z/12Z Vorne/Hinten	Pignon 12T et couronne 32T de différentiel AV/ARR	Anello differenziale/Pignone 32T/12T FR/RR
VTR232049	Complete Differential Set FR/RR	Diff Komplettsset Vorne/Hinten	Différentiel complet AV/ARR	Set differenziale completo FR/RR
VTR234013	Suspension Pivot Balls & Washer Set	Pivotkugel und Scheibenset	Jeu de rondelles et de rotules de suspension	Set rondelle e attacchi a sfera sospensioni
VTR234014	Suspension Arm Set FR/RR Upper & Lower	Querlenkerset Vorne/Hinten	Jeu de bras de suspension inférieur et supérieur AV/ARR	Set bracci sospensioni FR/RR super. infer.
VTR234017	Upper Suspension Arm Mount FR/RR	Querlenkerhalter Vorne/Hinten	Support de bras de suspension supérieurs AV/ARR	Supporto braccio super. sospensioni FR/RR
VTR234018	Shock Tower Set FR/RR	Dämpferbrücke	Jeu de supports d'amortisseurs AV/ARR	Set torre ammortizzatori FR/RR
VTR235225	M3 x38mm Button Head Inner Hinge Pin Screw	Rundkopfstiftschraube Hinge Pin Innen M3x38mm	Vis/axe de suspension intérieur M3x38mm	M3 x38mm Vite a testa bombata

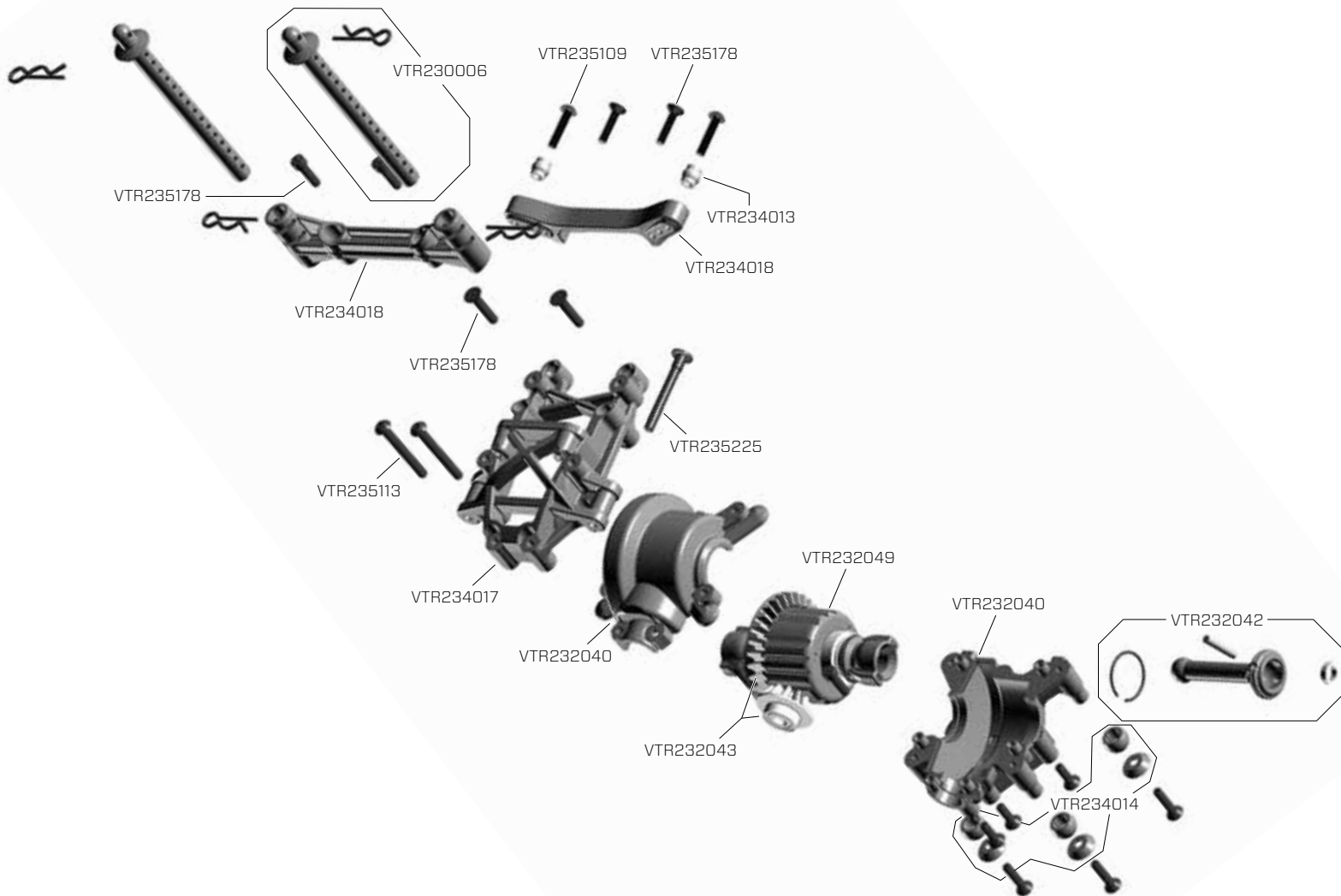

DIFFERENTIAL // DIFFERENTIAL // DIFFÉRENTIEL // DIFFERENZIALE //////////////////////////////////////

Part # Nummer Numéro Codice	Description	Beschreibung	Description	Descrizione
VTR232043	Diff Ring/Pinion 32T/12T FR/RR	Kegelrad und Triebbling 32Z/12Z Vorne/Hinten	Pignon 12T et couronne 32T de différentiel AV/ARR	Anello diff./pignone 32T/12T FR/RR
VTR232046	Bevel Gear Shaft FR/RR & Pins	Kegelradsatz mit Wellen	Axe de pignon d'attaque AV/ARR avec goupilles	Albero coppia conica FR/RR & perni
VTR232047	Diff Outdrive Cup Set FR/RR	Antriebsklauenset Vorne/Hinten	Jeu de noix de sortie de différentiel AV/ARR	Set trascinatori diff. FR/RR
VTR232048	Diff Housing and Spacers	Diffgehäuse inkl. Shimscheiben	Corps de différentiel avec cales	Scatola diff. e distanziali
VTR232049	Complete Differential Set FR/RR	Diff Komplettset Vorne/Hinten	Différentiel complet AV/ARR	Set completo differenziale FR/RR
VTR242006	Differential Internals	Diff Kegelradset	Éléments internes de différentiel	Interni differenziale
VTR246001	Screw Pin, Clip Post	Stiftschraube (10)	Noix de sortie avec goupille	Perno vite, clip post

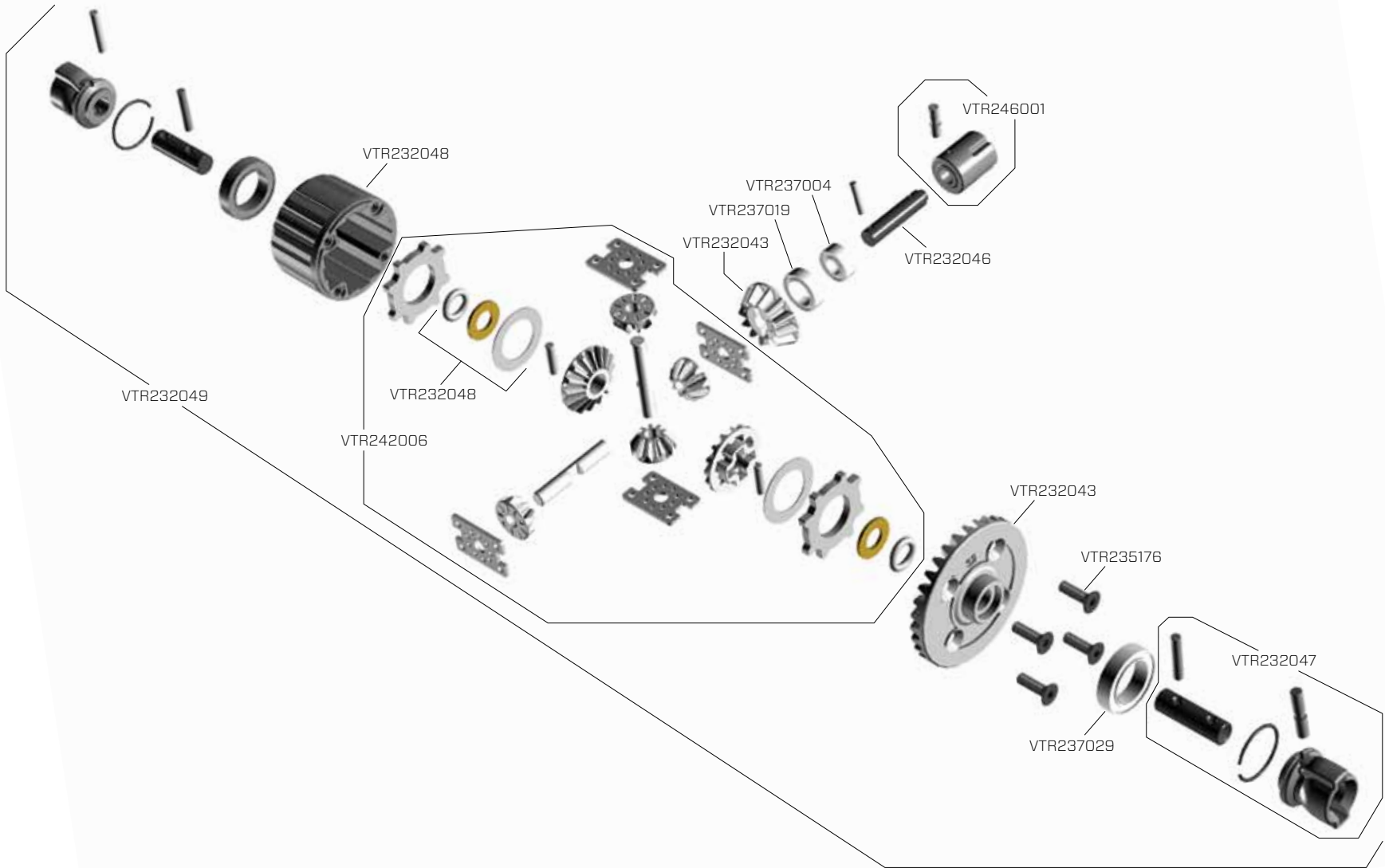

CHASSIS // CHASSIS // CHÂSSIS // TELAIO //////////////////////////////////////

Part # Nummer Numéro Codice	Description	Beschreibung	Description	Descrizione
DYN1172	Dynamite 15-Turn Brushed Motor	Dynamite 15-Turn Bürstenmotor	Moteur Dynamite 15T à balais	Dynamite 15-spire motore c/spazzole
DYN2210	Dynamite 12T ESC	Dynamite 12T ESC	Dynamite 12T ESC	Dynamite 12T ESC
SPMSS6170	S6170 Std. Digital Servo	S6170 Std. Digital Servo	S6170 Std. Servo Digital	S6170 Std. Servo Digitale
VTR230030	1969 Chevrolet Corvette Body Set Painted	Vaterra 1969 Chevrolet Corvette Karosserie lackiert	Carrosserie peinte Chevrolet Corvette 69	Set carrozzeria verniciata per 1969 Chevrolet Corvette
VTR230031	1969 Chevrolet Corvette Body Set Unpainted	Vaterra 1969 Chevrolet Corvette Karosserie transparent	Carrosserie transparente Chevrolet Corvette 67	Set carrozzeria non verniciata per 1969 Chevrolet Corvette
VTR231007	Steering Servo Saver Set & Servo Mounts	Servosaver und Servobefestigung	Sauve servo et supports de servo	Set salva servo sterzo & supporti servo
VTR231010	Chassis Set	Chassis Set	Châssis avec renfort	Set telaio
VTR231011	Battery Strap & Mounts	Akku Montageset	Support de batterie	Fascetta batteria e supporti
VTR231013	Antenna Mount Set	Montageset Antenne	Support d'antenne	Set supporto antenna
VTR232041	Center Drive Shaft	Antriebswelle Mitte	Cardan central	Albero trasmissione centrale
VTR232045	Center Diff Joint & Screw pin	Antriebsklauen Mitteldiff & Stiftschraube	Noix de sortie de différentiel central avec vis de liaison	Giunto diff. centrale & perno vite
VTR232050	Gear Cover Motor Plate Heat Shield Set	Getriebeschutzkappe und Motormontageplatte	Set de protection de transmission et de refroidisseur moteur	Piastra motore copertura ingranaggi e protezione calore
VTR232045	Center Diff Joint & Screw pin	Antriebsklauen Mitteldiff & Stiftschraube	Noix de sortie de différentiel central avec vis de liaison	Giunto diff. centrale & perno vite
VTR232050	Gear Cover Motor Plate Heat Shield Set	Getriebeschutzkappe und Motormontageplatte	Set de protection de transmission et de refroidisseur moteur	Piastra motore copertura ingranaggi e protezione calore

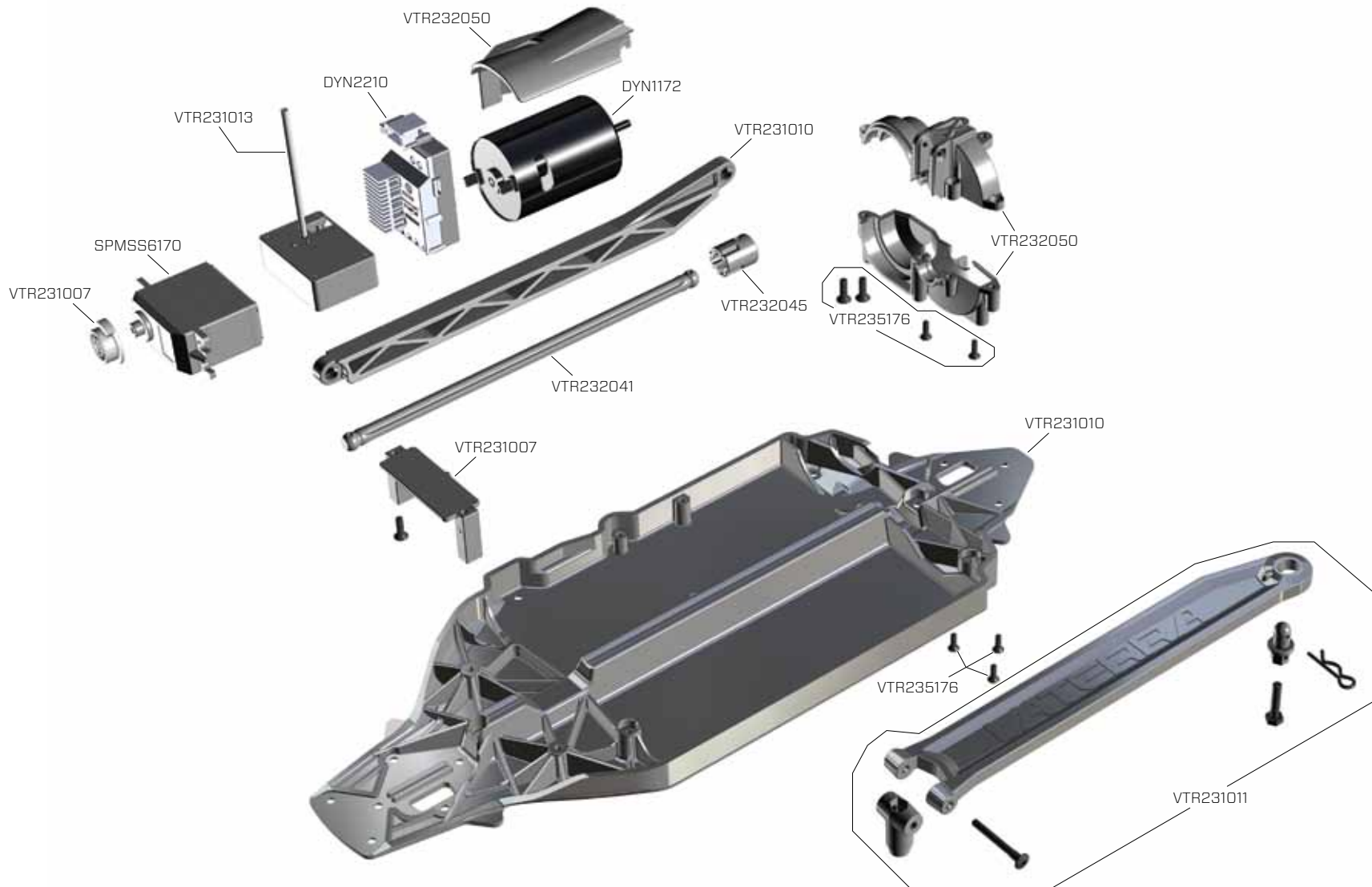

OPTIONAL PARTS // DIVERSE TEILE // PIÈCES OPTIONNELLES // COMPONENTI OPZIONALI //

Part # Nummer Numéro Codice	Description	Beschreibung	Description	Descrizione
VTR43002	Wheel FR/RR 54x26mm Mesh TC Black (2)	Felge Vorne/Hinten 54x26mm Mesh TC Schwarz 2St.	Jante nid d'abeille AV/ARR 54x26mm, noire (2)	Ruote FF/RR 54x26mm Mesh TC nere (2)
VTR43005	Wheel FR Deep Mesh 54x26mm Matte Gun Metal (2)	Felge Vorne Deep Mesh 54x26mm Gun Metal 2St.	Jante nid d'abeille à déport AV 54x26mm, grise acier matte (2)	Cerchio ruota FR 54x26mm canna di fucile (2)
VTR43006	Wheel Rr Deep Mesh 54X30mm Matte Gun Metal (2)	Felge Hinten Deep Mesh 54x30mm Gun Metal 2St.	Jante Nid D'abeille À Déport Arr 54X30mm, grise Acier Matte (2)	Cerchio ruota RR 54x30mm canna di fucile (2)
VTR43007	Wheel FR Deep Mesh 54x26mm Black Chrome (2)	Felge Vorne Deep Mesh 54x26mm Schwarz Chrom (2)	Jante AV Nid d'abeille 54x26mm Chrome noir (2)	Ruote FR 54x26mm Deep Mesh Nero/cromo (2)
VTR43008	Wheel RR Deep Mesh 54x30mm Black Chrome (2)	Felge Hinten Deep Mesh 54x30mm Schwarz Chrom (2)	Jante AR Nid d'abeille 54x30mm Chrome noir (2)	Ruote RR 54x30mm Deep Mesh Nero/cromo (2)
VTR43009	Wheel FR Nissan GTR 54x26mm Gun Metal (2)	Felge Vorne Nissan GTR 54x26mm Gun Metal 2st.	Jante AV Nissan GTR 54X26mm, grise acier (2)	Ruota Nissan FR GTR 54x26mm canna di fucile (2)
VTR43010	Wheel RR Nissan GTR 54x30mm Gun Metal (2)	Felge Hinten Nissan GTR 54x30mm Gun Metal 2st.	Jante ARR Nissan GTR 54X30mm, grise acier (2)	Ruota Nissan RR GTR 54x30mm canna di fucile (2)
VTR43011	Tire 67x26mm V1 Performance S Compound (2)	Reifen 67x26mm V1 Performance Weich(2)	Pneu V1 performance S Compound 67x26mm (2)	Gomme 67x26mm V1 Performance S Compound (2)
VTR43012	Tire 67x30mm V1 Performance S Compound (2)	Reifen 67x30mm V1 Performance Weich(2)	Pneu V1 performance S Compound 67x30mm (2)	Gomme 67x30mm V1 Performance S Compound (2)
VTR43013	Tire 67x26mm V1 Slick S compound (2)	Reifen 67x26mm V1 Slick Weich (2)	Pneu V1 Slick S Compound 67x26mm (2)	Gomme 67x26mm V1 Slick S compound (2)
VTR230002	2012 Chevrolet Camaro ZL-1 Body Set Unpainted	Chevrolet Camaro ZL-1 2012 Body Set unlackiert	Carrosserie à peindre Chevrolet Camaro ZL-1 2012	2012 Chevrolet Camaro ZL-1 Set carrozzeria non verniciata
VTR230003	2012 Nissan GTR Body Set Unpainted	Nissan GTR 2012 Body Set unlackiert	Carrosserie à peindre Nissan GTR 2012	Set carrozzeria 2012 Nissan GTR non verniciata
VTR230004	2012 Nissan GTR GT3 Body Set Unpainted	Nissan GTR GT3 2012 Body Set unlackiert	Carrosserie à peindre Nissan GTR GT3 2012	Set carrozzeria 2012 Nissan GTR GT3 non verniciata
VTR230005	1969 Chevrolet Camaro RS Body Set Unpainted	Chevrolet Camaro RS 1969 Body Set unlackiert	Carrosserie à peindre Chevrolet Camaro RS 1969	Set carrozzeria 1969 Chevrolet Camaro RS non verniciata
VTR230006	Body Post Set	Karosseriehalter Set	Set de supports de carrosserie	Set supporti carrozzeria
VTR230007	2012 Chevrolet Camaro ZL-1 Body Set Red	Chevrolet Camaro ZL-1 2012 Karosserie Rot	Carrosserie rouge Chevrolet Camaro ZL1 2012	2012 Chevrolet Camaro ZL-1 Set carrozzeria rossa

Part # Nummer Numéro Codice	Description	Beschreibung	Description	Descrizione
VTR230008	2012 Nissan GTR Body Set Black	Nissan GTR 2012 Karosserie Schwarz	Carrosserie noire Nissan GTR 2012	Set carrozzeria 2012 Nissan GTR nera
VTR230009	2012 Nissan GTR GT3 Body Set Factory Test Blue	Nissan GTR GT3 2012 Karosserie dunkel Blau	Carrosserie bleue foncée Nissan GTR GT3 2012	Set carrozzeria 2012 Nissan GTR GT3 blu scura
VTR230010	1969 Chevrolet Camaro RS Body Set Gun Metal	Chevrolet Camaro RS 1969 Karosserie Gun Metal	Carrosserie grise foncée Chevrolet Camaro RS 1969	Set carrozzeria 1969 Chevrolet Camaro RS grigio metallizzato
VTR231009	Bumper Rear	Vaterra Stoßfängerset Hinten	Pare-choc arrière	Paraurti posteriore
VTR233008	Shock Spring Soft Yellow (2)	Feder Gelb/Weich	Ressort d'amortisseur souple, jaune (2)	Molla ammortizz. morbida gialla (2)
VTR233009	Shock Spring Medium Silver (2)	Feder Silber/Mittel	Ressort d'amortisseur moyen, argent (2)	Molla ammortizz. media argento (2)
VTR233010	Shock Spring Firm Green (2)	Feder Hart/Grün	Ressort d'amortisseur dur, vert (2)	Molla ammortizz. dura verde (2)
VTR234016	Rear Upright Set LH/RH	Radträgerset Hinten L/R	Jeu de fusées arrière	Set superiore poster. LH/RH



VATERRA®

It is a shared passion for motorsports and radio control. Extreme performance and extreme places. Cars and trucks that look and drive just like the real thing. Most of all, it is about gathering friends, grabbing a vehicle and having the time of your life.

Adventure Driven.™

©2014 Horizon Hobby, LLC.

Vaterra, the Vaterra logo, Adventure Driven., Dynamite, DSM and Speedpack are trademarks or registered trademarks of Horizon Hobby, Inc.

The Spektrum trademarks is used with permission of Bachmann Industries, LLC.

Chevrolet, Corvette, all related Emblems, and vehicle body designs are General Motors Trademarks used under license to Horizon Hobby, Inc.

Created 2/14 42179