

Exploded View and Parts Listings

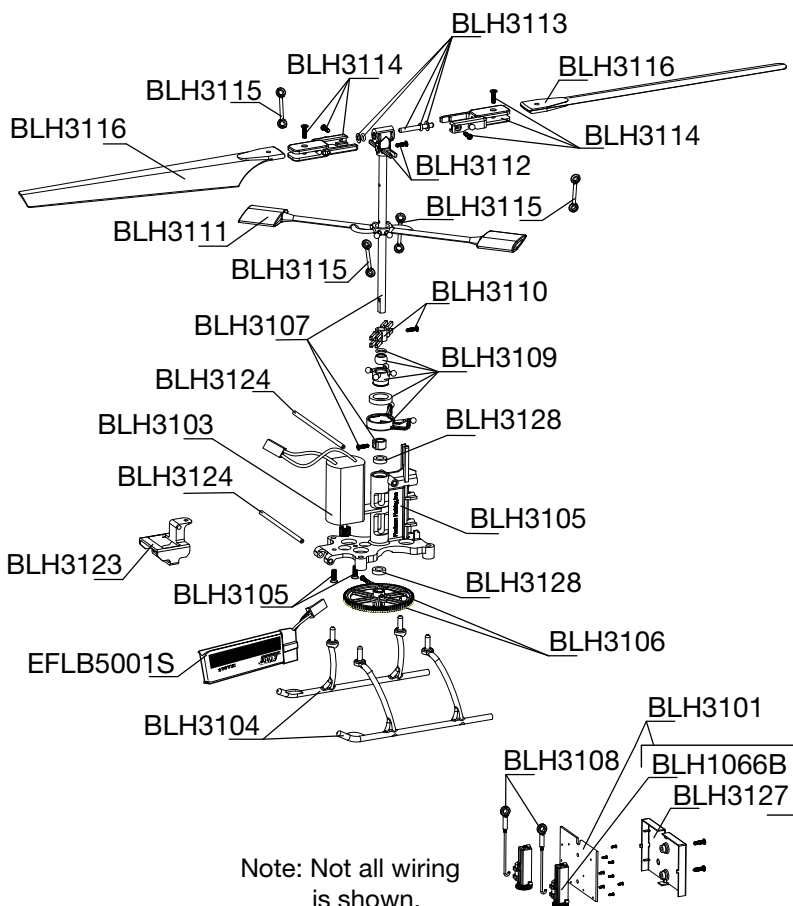

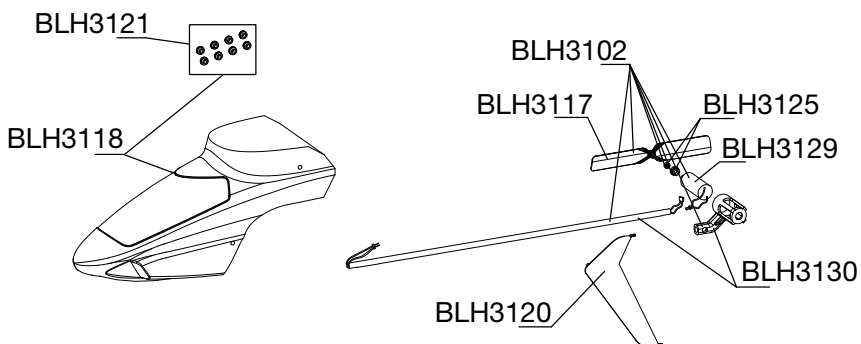







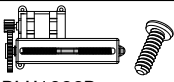

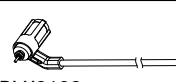

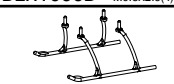
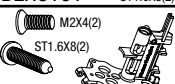
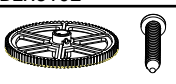
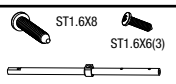

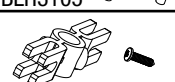
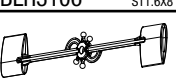
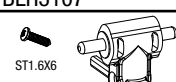
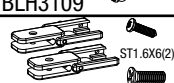
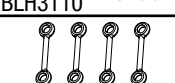

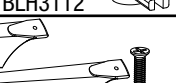

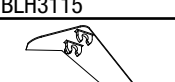
Note: Ball bearing (BLH3125) needs to face step on tail rotor (BLH3117).

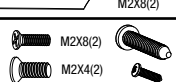

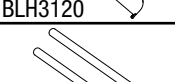
Replacement Parts

These parts are available at your local hobby shop or from Horizon Hobby (www.bladehelis.com). Please try your local hobby shop first. By supporting them, they will be there when you need them.

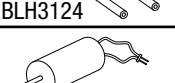
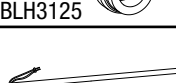
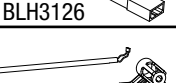
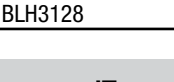
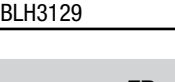
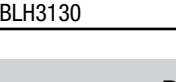
| Number | Description | Number | Description |
|----------|---|-----------|---|
| BLH1066B | Replacement Servo Mechanics | BLH3116 | Main Rotor Blade Set with Hardware |
| BLH3101 | 5-in-1 Control Unit/Servo/Receiver/ESC/Mixer/Gyro | BLH3117 | Tail Rotor (1) |
| BLH3102 | Tail Boom Assembly with Motor/Mount/Rotor | BLH3118 | Complete Canopy with Grommets |
| BLH3103 | Main Motor with Pinion | BLH3120 | Vertical Fin with Decal |
| BLH3104 | Landing Skid (Left/Right) | BLH3121 | Canopy Mounting Grommet (8) |
| BLH3105 | Mainframe with Hardware | BLH3122 | Hardware Set |
| BLH3106 | Main Gear | BLH3123 | Battery Mount |
| BLH3107 | Main Shaft with Hardware | BLH3124 | Front and Rear Carbon Fiber Body Mount |
| BLH3108 | Servo Pushrod Set with Ball Link (2) | BLH3125 | Tail Motor Protective Sleeve |
| BLH3109 | Complete Precision Swashplate | BLH3126 | JST-RCY to Ultra-Micro Battery Adapter Lead |
| BLH3110 | Anti-Rotation Collar with Hardware | BLH3127 | 5-in-1 Control Unit Cover: 120SR |
| BLH3111 | Mixing Flybar | BLH3128 | Main Shaft Bearing 4 x 7 x 2 |
| BLH3112 | Main Rotor Hub with Hardware | BLH3129 | Tail Motor |
| BLH3113 | Feathering Spindle with O-rings and Bushings | BLH3130 | Tail Boom and Mount Only |
| BLH3114 | Main Blade Grips with Hardware | EFLB5001S | 500mAh 1-Cell 3.7V 12C Li-Po |
| BLH3115 | Rotor Head Link Set (4) | | |

| | | | |
|---|--|---|--|
|  BLH1066B M0.8X2.5(4) |  BLH3101 ST1.6X8(2) |  BLH3102 |  BLH3103 |
|  BLH3104 |  BLH3105 M2X4(2) ST1.6X8(2) |  BLH3106 ST1.6X8 |  BLH3107 ST1.6X8 ST1.6X6(3) |
|  BLH3108 |  BLH3109 |  BLH3110 ST1.6X6 |  BLH3111 |
|  BLH3112 ST1.6X6(2) M2X8(2) |  BLH3113 0 1 1 0 |  BLH3114 |  BLH3115 |
|  BLH3116 M2X8(2) |  BLH3117 |  BLH3118 |  BLH3119 M2X4(2) ST1.6X8(3) ST1.6X6(5) M0.8X2.5(8) |
|  BLH3120 |  BLH3121 |  BLH3122 |  BLH3123 |
|  BLH3124 |  BLH3125 |  BLH3126 |  BLH3127 |
|  BLH3128 |  BLH3129 |  BLH3130 |  EFLB5001S |