

# Super Cub 25e ARF

Assembly Manual



PLATINUM  
SERIES

**E-flite**<sup>®</sup>  
ADVANCING ELECTRIC FLIGHT

## Notice

All instructions, warranties and other collateral documents are subject to change at the sole discretion of Horizon Hobby, Inc. For up-to-date product literature, visit <http://www.horizonhobby.com> and click on the support tab for this product.

## Meaning of Special Language

The following terms are used throughout the product literature to indicate various levels of potential harm when operating this product:

**NOTICE:** Procedures, which if not properly followed, create a possibility of physical property damage AND a little or no possibility of injury.

**CAUTION:** Procedures, which if not properly followed, create the probability of physical property damage AND a possibility of serious injury.

**WARNING:** Procedures, which if not properly followed, create the probability of property damage, collateral damage, and serious injury OR create a high probability of superficial injury.

 **WARNING:** Read the ENTIRE instruction manual to become familiar with the features of the product before operating. Failure to operate the product correctly can result in damage to the product, personal property and cause serious injury.

This is a sophisticated hobby product and NOT a toy. It must be operated with caution and common sense and requires some basic mechanical ability. Failure to operate this Product in a safe and responsible manner could result in injury or damage to the product or other property. This product is not intended for use by children without direct adult supervision. Do not attempt disassembly, use with incompatible components or augment product in any way without the approval of Horizon Hobby, Inc. This manual contains instructions for safety, operation and maintenance. It is essential to read and follow all the instructions and warnings in the manual, prior to assembly, setup or use, in order to operate correctly and avoid damage or serious injury.

## Warnings

Read and follow all instructions and safety precautions before use. Improper use can result in fire, serious injury and damage to property.

**Age Recommendation: Not for children under 14 years.** This is not a toy.

## COMPONENTS

Use only with compatible components. Should any compatibility questions exist, please refer to the product instructions, the component instructions or contact Horizon Hobby, Inc.

## FLIGHT

Fly only in open areas to ensure safety. It is recommended flying be done at AMA (Academy of Model Aeronautics) approved flying sites. Consult local laws and ordinances before choosing a location to fly your aircraft.

## PROPELLER

Keep loose items that can get entangled in the propeller away from the prop, including loose clothing or other objects such as pencils and screwdrivers. Especially keep your hands away from the propeller as injury can occur.

## BATTERIES

### Notes on Lithium Polymer Batteries

When misused, lithium polymer batteries are significantly more volatile than alkaline or Ni-Cd/ Ni-MH batteries used in RC applications. Always follow the manufacturer's instructions when using and disposing of any batteries. Mishandling of Li-Po batteries can result in fire causing serious injury and damage.

## SMALL PARTS

This kit includes small parts and should not be left unattended near children as choking and serious injury could result.

## SAFETY PRECAUTIONS

- Check all control surfaces prior to each takeoff.
- Do not fly your model near spectators, parking areas or any other area that could result in injury to people or damage of property.
- Do not fly during adverse weather conditions. Poor visibility and/or strong winds can cause disorientation and loss of control of your aircraft.
- Do not take chances. If at any time during flight you observe any erratic or abnormal operation, land immediately and do not resume flight until the cause of the problem has been ascertained and corrected. Safety can never be taken lightly.
- Do not fly near power lines.

## Table of Contents

Introduction .....	3
Important Information Regarding	
Warranty Information .....	3
Specifications .....	3
Using the Manual .....	3
Contents of Kit/Parts Layout .....	4
Covering Colors.....	4
Hardware/Accessory Sizes .....	4
Recommended Radio Equipment.....	4
Power 25 Motor Setup .....	4
Power 32 Motor Setup .....	4
Optional Accessories .....	4
Required Tools and Adhesives .....	5
Before Starting Assembly .....	5
Hinging the Ailerons and Flaps .....	5
Aileron and Flap Servo Installation .....	8
Motor and Speed Control Installation .....	13
Cowling, Propeller and Flight Battery Installation .....	14
Landing Gear Installation .....	15
Stabilizer and Tail Bracing Installation.....	18
Elevator Installation .....	20
Rudder Installation .....	22
Tail Wheel Installation .....	26
Rudder and Elevator Servo and Linkage Installation..	27
Receiver Installation without Cockpit Kit.....	30
Receiver Installation with Cockpit Kit .....	30
Servo Hatch Cover Installation.....	31
Window and Seat Installation.....	31
Cockpit Kit Installation (Optional).....	33
Wing and Wing Strut Installation.....	34
Lighting Kit Installation (Optional) .....	36
Accessory Installation .....	38
Center of Gravity .....	39
Control Throws .....	40
Preflight.....	40
Range Test Your Radio.....	41
Flying Your Model.....	41
Daily Flight Checks .....	42
Limited Warranty .....	42
Warranty Services .....	43
Compliance Information for the European Union .....	44
Academy of Model Aeronautics	
National Model Aircraft Safety Code .....	44

## Introduction

For more than half a century, Piper's Super Cub has been a favorite of general aviation pilots who spend most of their time off the beaten path. Its respectable power, excellent short field performance and rugged design have made it perfect for back country transportation, towing gliders or simply getting away from it all.

The Super Cub 25e ARF expertly captures the look and feel of this aviation classic with an accurate scale outline and features unlike anything ever seen in its power class. This Platinum Series airplane offers numerous scale details such as a traditional Super Cub scheme, molded corrugation on the ailerons and functional flaps, painted aluminum wing struts, functional shock-absorbing landing gear with scale Cub wheels and tires, functional split cockpit door, and more.

But, even with all these scale features, E-flite didn't overlook ease of assembly. The two-piece wing and magnetically secured, factory painted fiberglass cowling are just a couple of the convenient design features that make the Super Cub 25e a breeze to assemble. Even if you add the optional cockpit and light kits, you can have your airplane ready to fly in a few evenings. And it will be virtually indistinguishable from its full scale counterpart and sure to be the envy of everyone at your flying field!

## Important Information Regarding Warranty Information

Please read our Warranty and Liability Limitations section before building this product. If you as the Purchaser or user are not prepared to accept the liability associated with the use of this Product, you are advised to return this Product immediately in new and unused condition to the place of purchase.

### Specifications

Wingspan:	68.0 in (1730mm)
Length:	45.5 in (1160mm)
Wing Area:	670 sq in (43.3 sq dm)
Weight with battery:	5.85–6.40 lb (2.65–2.9 kg)
Weight w/o battery:	5.00–5.60 lb (2.30–2.55 kg)

### Using the Manual

This manual is divided into sections to help make assembly easier to understand, and to provide breaks between each major section. In addition, check boxes have been placed next to each step to keep track of its completion. Steps with a single circle (○) are performed once, while steps with two or more circles (○○) indicate the step will require repeating, such as for a right or left wing panel, two servos, etc.

Remember to take your time and follow the directions.

## Contents of Kit/Parts Layout

### Replacement Parts

EFL460001	Wing Set
EFL460002	Fuselage
EFL460003	Tail Set
EFL460004	Rudder
EFL460005	Cowling
EFL460006	Windshield
EFL460007	Top Window
EFL460008	Window Set
EFL460009	Wing Tube
EFL460010	Wheel Set
EFL460011	Tail Wheel
EFL460012	Pushrod Set
EFL460013	Seat Set
EFL460014	Strut Set
EFL460015	Accessory Set
EFL460016	Landing Gear
EFL460017	Hardware Set
EFL460019	Fuselage Hatch
EFL460020	Servo Hatch

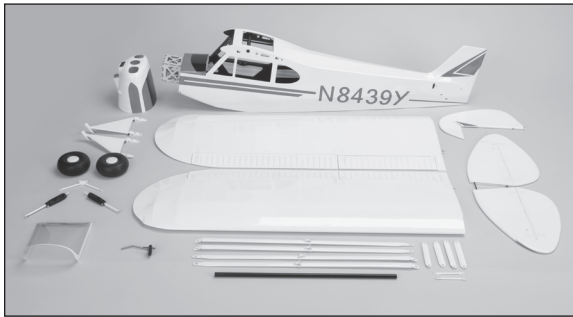

### Covering Colors

White	HANU870
True Red	HANU866

## Hardware/Accessory Sizes

Wheel diameter	3.35-inch (85mm)
Wing bolts	1/4-20 x 5/8-inch

### Recommended Radio Equipment

You will need a minimum 5-channel transmitter, receiver and six servos. You can choose to purchase a complete radio system, or if you are using an existing transmitter, purchase the other required equipment separately. We recommend the crystal-free, interference-free Spektrum™ DX8 2.4GHz DSM2™ / DSMX™ 8-channel system.

If you own the Spektrum DX8 radio or are using a different DSM2™/DSMX™ radio, just add the AR7010 7-channel DSMX receiver and six Spektrum A5030 mini digital servos.

#### Complete Radio System

SPM8800	DX8 DSMX 8CH system
---------	---------------------

#### Or Purchase Separately

SPMAR7010	AR7010 7CH DSMX™ Receiver
SPMSA5030	A5030 Mini Digital Aircraft Servo (6)
SPMA3051	6-inch (152mm) Servo Extension (2) (Aileron wing extensions)
SPMA3052	9-inch (229mm) Servo Extension (ESC extension)
SPMA3053	12-inch (305mm) Servo Extension (2) (Aileron to fuse extensions)
SPMA3050	3-inch (152mm) Servo Extension (Bind plug extension)
SPMA3058	Standard Y-Harness (Receiver to flap fuselage extension)

## Power 25 Motor Setup

EFLM4025A	Power 25 BL Outrunner Motor, 870Kv
EFLA1060L	60-Amp Pro Switch-Mode BEC Brushless ESC
EFLB32004S30	3200mAh 4S 14.8V 30C Li-Po, 12AWG EC3
APC13065E	13 x 6.5E Electric Propeller

## Power 32 Motor Setup

EFLM4032A	Power 32 Brushless Outrunner Motor, 770Kv
EFLA1060	60-Amp Pro Switch-Mode BEC Brushless ESC
EFLB32004S30	3200mAh 4S 14.8V 30C Li-Po, 12AWG EC3
APC13065E	13 x 6.5E Electric Propeller

### Optional Accessories

EFLA110	Power Meter
EFLC3020	Celectra™ 200W DC Multi-Chemistry Battery Charger
EFLSP200	2-inch Aluminum Spinner with 4mm and 5mm Collets
EFL460018	Cockpit Kit

### LIGHTING KIT

EFLA600	Universal Light Kit Controller
EFLA602	Clear LED Solid (2ea) (2)
EFLA604	Green LED Solid (2ea)
EFLA601	Red LED Solid (2ea)
EFLA620	Extension 36-inch (2ea)
EFLA619	Extension 24-inch (2ea)
EFLA618	Extension 18-inch (2ea) (2)
EFLA617	Y-Harness Heavy Duty 6-inch
DUB435	DuBro 1/16-inch Shrinkwrap

## ***Etips***

We recommend installing the lighting kit and interior in the sequence of steps shown in the manual. Adding these items after the model is built may not be possible without causing damage to your airframe. Please decide prior to beginning construction whether or not you would like to incorporate these items in your airplane.

### **Required Tools and Adhesives**

#### **Tools & Equipment**

Box wrench: 10mm	Felt-tipped pen
Low-tack tape	Flat blade screwdriver
Isopropyl alcohol	Hobby knife with #11 blade
Paper towel	Nut driver: 1/4-inch
Petroleum jelly	Phillips screwdriver: #1, #2
Pin vise	Pliers
Ruler	Scissors
Side cutters	Square
Toothpick	T-pins
Mixing sticks	Mixing cups
Dental floss	Sandpaper
Drill bit: 1/16-inch (1.5mm), 5/64-inch (2mm), 7/64-inch (3mm)	
Hex wrench: 1.5mm, 2mm, 3/32-inch, 5/64-inch, 1/8-inch	

#### **Optional Tools & Equipment**

Balancing stand (optional)

#### **Adhesives**

30-minute epoxy	PAAPT39
Medium CA	PAAPT02
Thin CA	PAAPT08
Threadlock	PAAPT42
Formula 560 Canopy Glue	PAAPT56

### **Before Starting Assembly**

Before beginning the assembly of your model, remove each part from its bag for inspection. Closely inspect the fuselage, wing panels, rudder and stabilizer for damage. If you find any damaged or missing parts, contact the place of purchase.

If you find any wrinkles in the covering, use a heat gun (HAN100) and covering glove (HAN150) or covering iron (HAN101) with a sealing iron sock (HAN141) to remove them. Use caution while working around seams or areas where the colors overlap to prevent pulling the seams.

## ***Etips***

During the course of building your model, we suggest you use a soft base for the building surface.

Such things as a foam stand, large piece of bedding foam or a thick bath towel will work well and help protect the model from damage during assembly. This is not shown in the instructions to provide the greatest detail in the photos.

## ***Etips***

When referencing directions (up, down, left, right, top and bottom), take note that these are in relationship to the pilot sitting in the cockpit of the aircraft unless noted otherwise.

### **Hinging the Ailerons and Flaps**

#### **Required Parts**

Wing panel (right and left)  
Aileron (right and left)  
Flap (right and left) Flap hinge (6)  
CA hinge (8)

#### **Required Tools and Adhesives**

Side cutters	Petroleum jelly
T-pins	Toothpicks
Thin CA	Low-tack tape
Pin vise	Drill bit: 1/16-inch (1.5mm)
30-minute epoxy	Isopropyl alcohol
Mixing sticks	Epoxy cups
Paper towel	

1. Locate the wing panel. Separate the aileron and flap from the wing panel by removing the tape holding them to the wing panel.

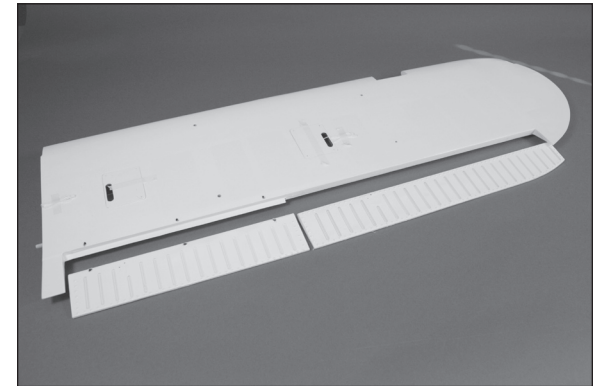

- 2. Locate three hinges for the flaps. Use side cutters to trim one end of each hinge to 11/16-inch (17mm). The trimmed end will be placed in the flap.

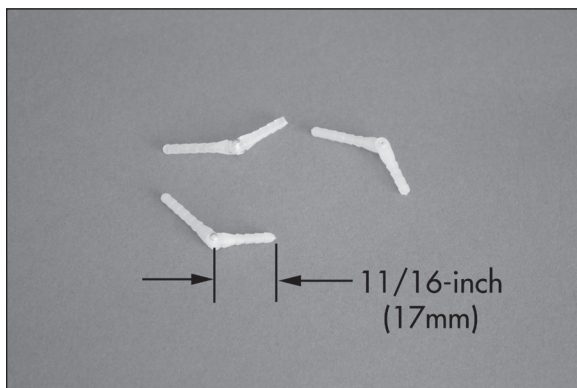

- 3. Insert the trimmed end of the hinges into the flap. Check that the hinge moves perpendicular to the hinge line. Also check to ensure that the hinge is not protruding through the top of the flap skin. If you see a bump, trim a little more off of the hinge.

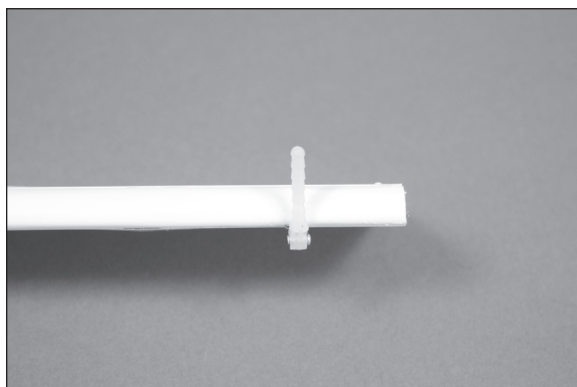

- 4. Fit the hinge and flap to the wing. Position the flap so it aligns with the wing and that the hinge line is equal along the entire length of the flap.

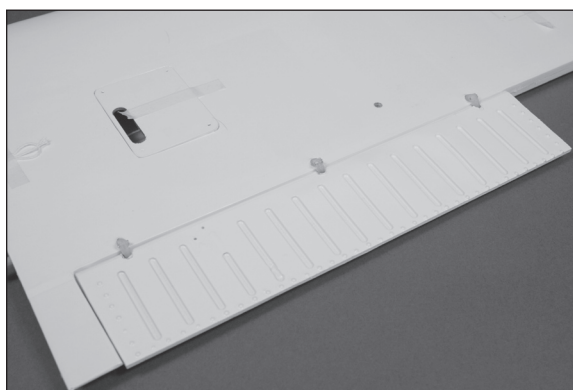
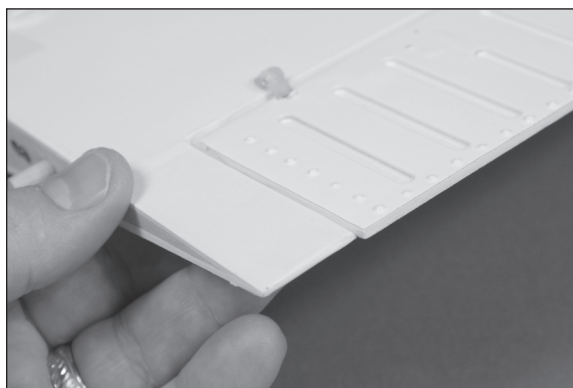

- 5. Check that the flap can move freely through its range of motion. This will ensure that the hinges are installed correctly.

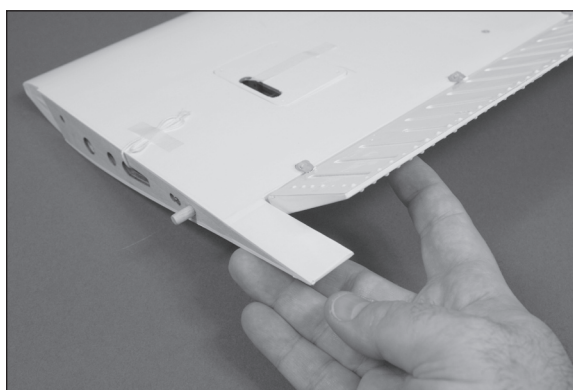

- 6. Remove each hinge and apply a small amount of petroleum jelly to the hinge point in order to help prevent the glue from penetrating the hinge which could prevent it from operating correctly.

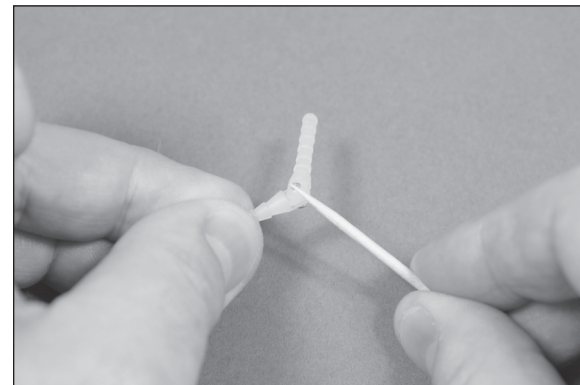

### ***E-tips***

Dipping the hinge knuckles in heated petroleum jelly (in a liquid state) is easier than trying to apply it with a toothpick in the gel state.

- 7. Remove the flap and hinges. Mix a small amount of 30-minute epoxy. Use a toothpick to apply the epoxy inside the holes in the wing and flap, then install the hinges. Check to make sure the flap is positioned as described in steps 4 and 5.

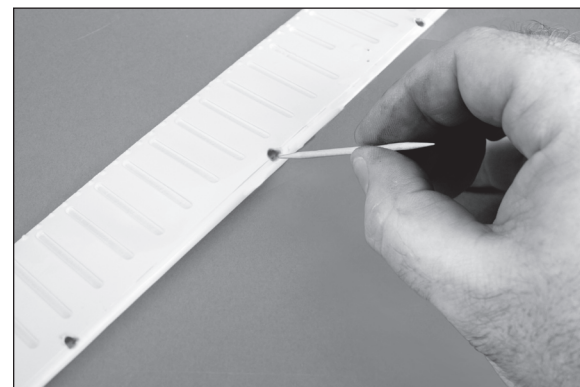

- 8. Use a small amount of low-tack tape to hold the flap in position until the epoxy fully cures. Use a paper towel and isopropyl alcohol to remove any excess epoxy before it cures.

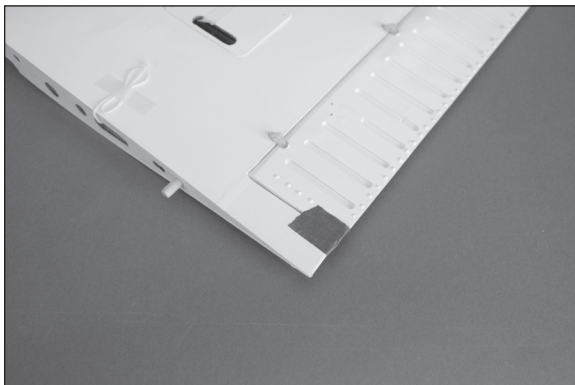

- 9. Repeat steps 1 through 8 to install the remaining flap.

- 10. Use a pin vise and 1/16-inch (1.5mm) drill bit to drill a hole in the center of each hinge slot in the aileron and wing to create a tunnel for the CA to wick into. This will allow the CA to penetrate the hinge, creating a better bond between the hinge and surrounding wood.

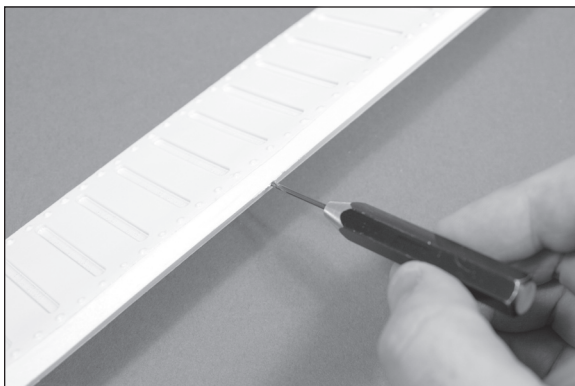

- 11. Place a T-pin in the center of each of the four hinges. This will center the hinges equally in the aileron and wing when they are installed.

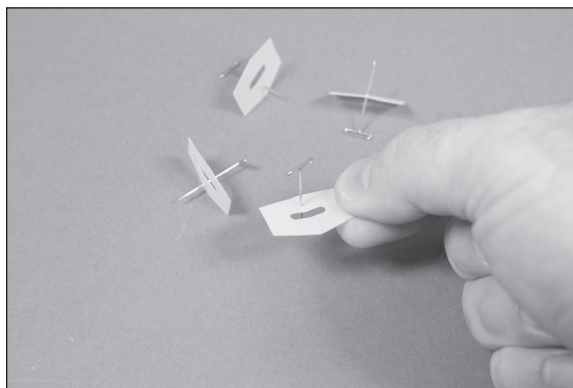

- 12. Insert the hinges in the ailerons. The T-pin will rest on the edge of the aileron bevel.

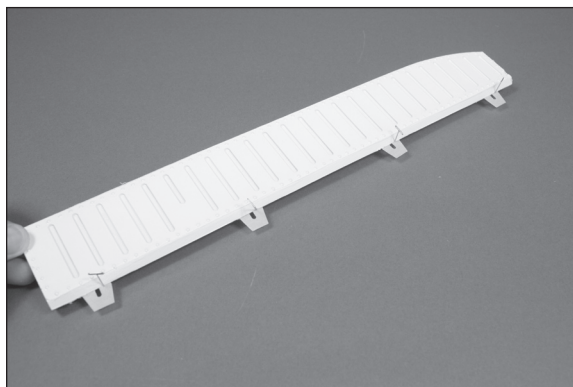

- 13. Slide the aileron into position, guiding the hinges into the hinge slots in the wing.

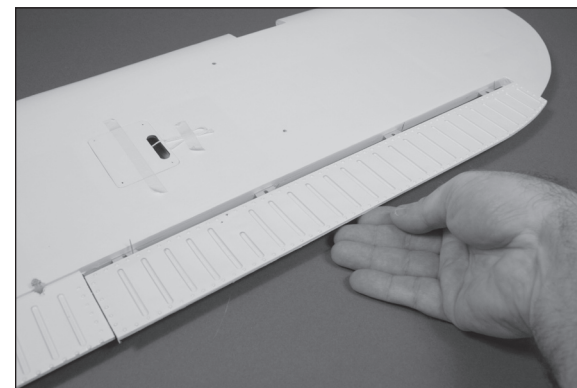

- 14. Remove the T-pins from the hinges. Position the aileron so the hinge gap is as small as possible. Also check that the aileron is centered between the flap and wing tip.

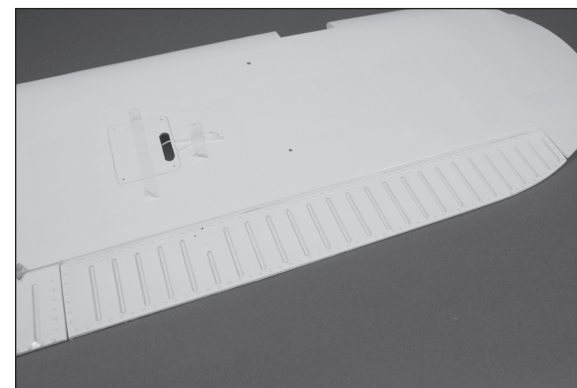

- 15. Saturate each hinge with thin CA. Apply CA to both the top and bottom of the hinge.



- 16. Once the CA has cured, gently pull on the control surface and wing to make sure the hinges are glued securely. If not, apply CA to those hinges that are not glued and recheck.

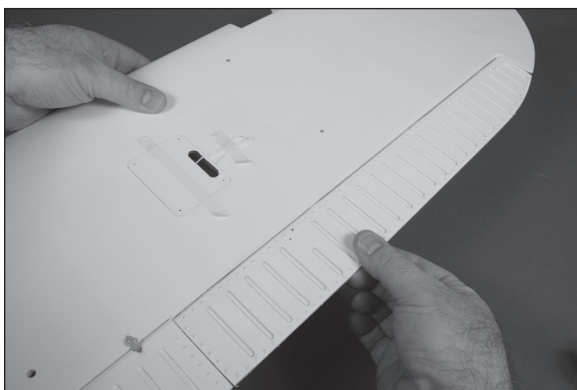

- 17. Move the control surface through its range of motion several times to break in the hinges. This will reduce the initial load on the servo during your first flights.



- 18. Repeat steps 10 through 17 to install the remaining aileron. Once the glue has fully cured on the flaps, remove the tape placed in step 8.

## Aileron and Flap Servo Installation

### Required Parts

- Wing panel (right and left)
- Transmitter
- Receiver
- Nylon clevis (4)
- Nylon control horn (4)
- Receiver battery
- Silicone tubing (4)
- Servo with hardware (4)
- 2mm x 8mm washer head self-tapping screw (16)
- 2mm x 8mm self-tapping screw (8)
- Aileron pushrod, 2<sup>2</sup>/<sub>16</sub>-inch (65mm) (2)
- Flap pushrod, 2<sup>5</sup>/<sub>16</sub>-inch (59mm) (2)
- Servo extension, 6-inch (152mm) (2)

### Required Tools and Adhesives

- Thin CA
- Phillips screwdriver: #1
- Pin vise
- Drill bit: 5/64-inch (2mm)
- Dental floss
- Hobby knife with #11 blade
- Canopy glue
- Low-tack tape

- 1. Remove the aileron servo cover from the wing. You may need to use a covering iron to reseal the covering to the wing if the tape lifts the covering.





- 2. Prepare the servo by installing the servo grommets and brass eyelets.

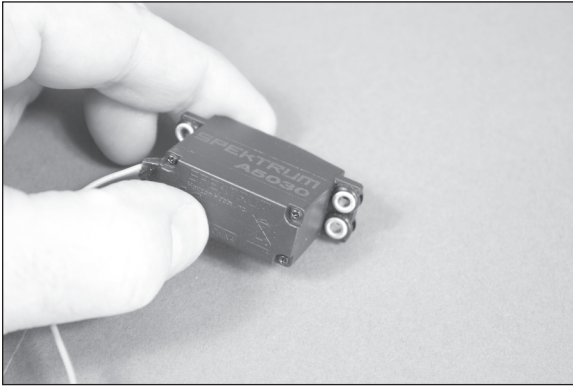

- 3. Use a #1 Phillips screwdriver to thread a servo mounting screw into each of the holes to cut threads in the surrounding wood. Remove the screw before moving to the next step.

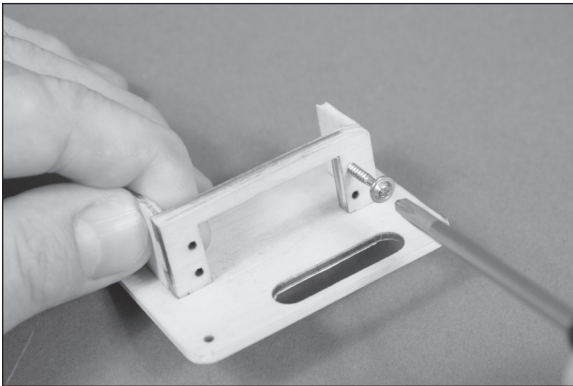

- 4. Apply 2–3 drops of thin CA in each of the holes to harden the surrounding wood. This will harden the threads so the screws do not easily strip the surrounding wood.

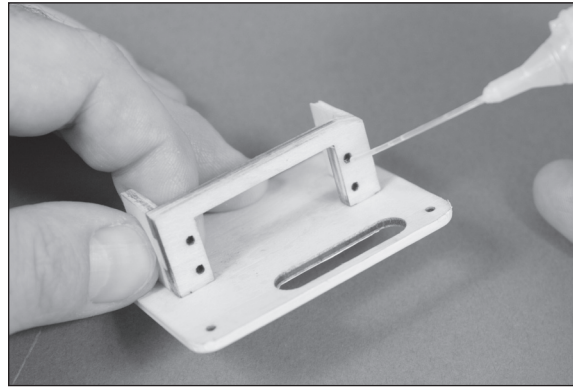

- 5. Secure the aileron servo to the servo mount using the hardware included with the servo. Use a #1 Phillips screwdriver to tighten the screws. Note that the output for the servo is centered in the slot where the servo arm will protrude through the cover.



- 6. Use a pin vise and 5/64-inch (2mm) drill bit to enlarge the hole in the servo horn. Enlarge the hole that is 5/8-inch (16mm) from the center of the horn for the ailerons (1/2-inch (13mm) for the flaps). Use side cutters to remove any unused arms so they don't interfere with the operation of the servo.

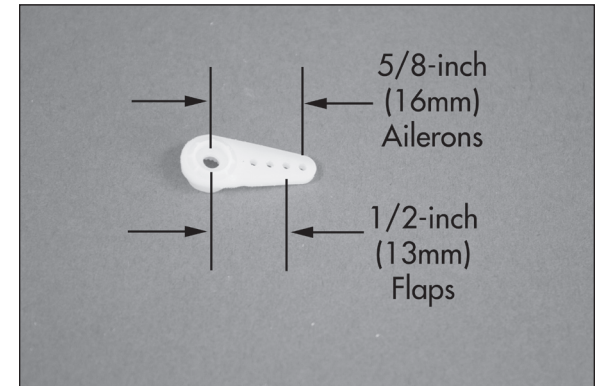

- 7. Use the radio system to center the aileron servo. Use the screw from the servo to install the servo horn on the servo as shown. Use a #1 Phillips screwdriver to tighten the screw that secures the servo horn to the servo output.

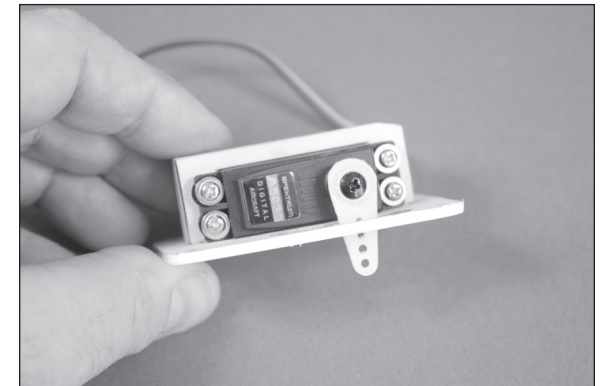

- 8. Repeat steps 2 through 7 for the flap servo.

- 9. Connect a 6-inch (152mm) servo extension to the servo lead. Use a string or piece of dental floss to secure the leads so they do not accidentally disconnect inside the wing.

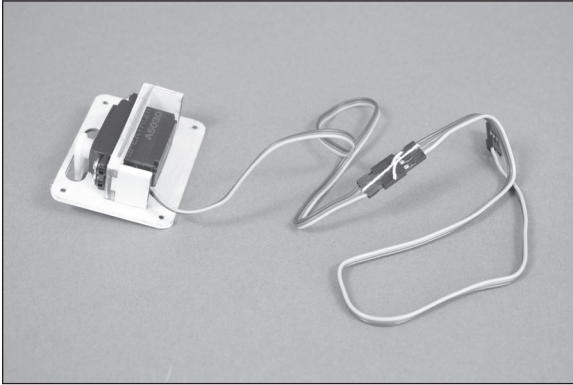

- 10. A string is located in the wing to pull the servo lead through the wing. Tie the string to the end of the servo lead as shown.



- 11. Remove the flap servo cover and use the string to pull the aileron extension through the area of the hatch for the flap servo.



- 12. Use a #1 Phillips screwdriver to thread a 2mm x 8mm washer-head self-tapping screw into each of the holes to cut threads in the surrounding wood. Remove the screw before moving to the next step.



- 13. Apply 2-3 drops of thin CA in each of the holes to harden the surrounding wood. This will harden the threads so the screws do not easily strip the surrounding wood.

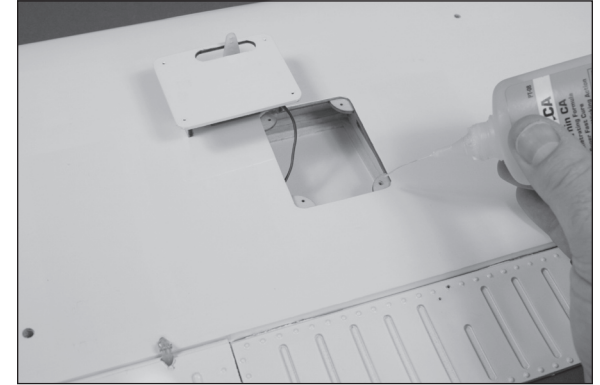

- 14. Install the servo cover using four 2mm x 8mm washer-head, self-tapping screws and a #1 Phillips screwdriver.

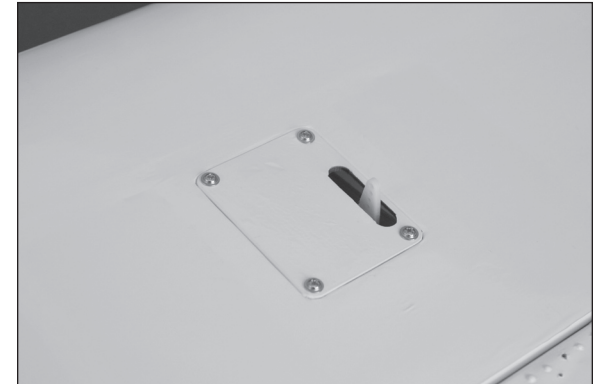

- 15. Use a #1 Phillips screwdriver to thread a 2mm x 8mm self-tapping screw into each of the pre-drilled holes to cut threads in the surrounding wood. Remove the screw before moving to the next step.

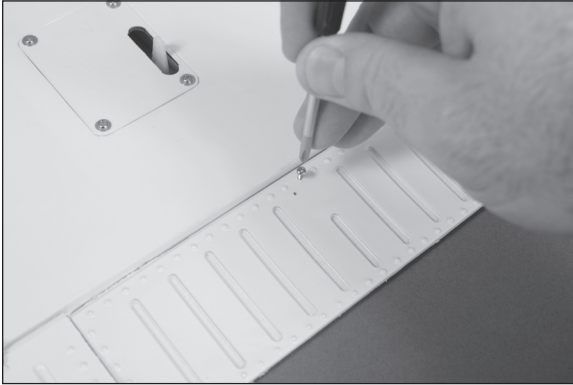

- 16. Apply 2-3 drops of thin CA in each of the holes to harden the surrounding wood. This will harden the threads so the screws do not easily strip the surrounding wood.



- 17. Remove the control horn backplate from the control horn using a hobby knife and #11 blade. The backplate can be discarded as it is not used in the assembly of your model.

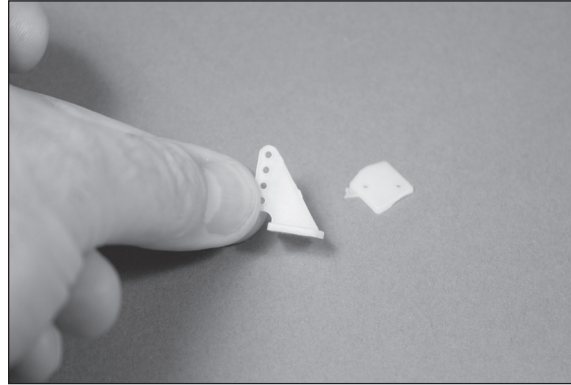

- 18. Install the servo horn using two 2mm x 8mm self-tapping screws and a #1 Phillips screwdriver.



- 19. Slide the small piece of silicone tubing in a nylon clevis. Thread the clevis 12-turns on a threaded pushrod wire. This will provide enough threads in the clevis to be secure and allow for adjustment of the linkage.

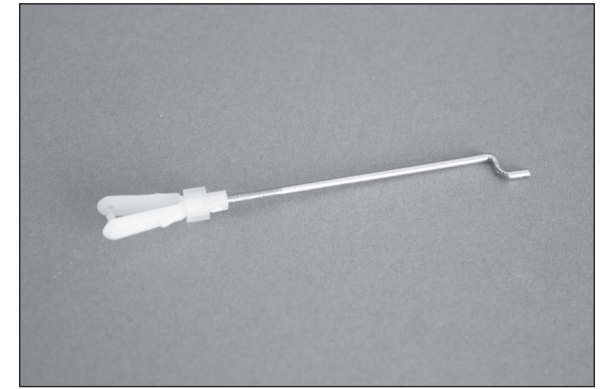

The aileron pushrod measures  $2\frac{9}{16}$ -inches (65mm), while the flap pushrod measures  $2\frac{5}{16}$ -inches (59mm). Make sure to use the correct linkage in the correct location.

- 20. Repeat steps 9 through 19 for the flap servo.
- 21. Attach the pushrod wire to the servo horn using the bend in the wire. With the servo centered, connect the clevis to the outer hole on the control horn. Make sure the aileron is centered when the clevis is connected. Adjust the clevis as needed to center the aileron. Slide the tubing over the forks of the clevis to keep it from opening accidentally in flight.



## Aileron and Flap

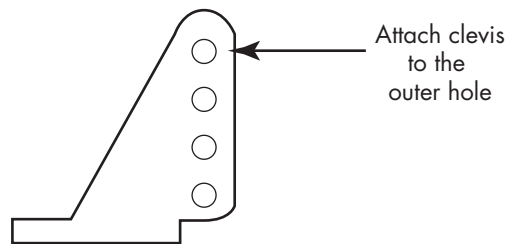

Drawing not to scale

- 22. Repeat steps 1 through 19 to install the remaining aileron servo.

If you are using a 2-position flap switch, still set the center position as a starting point for the flap linkage installation.

- 23. Connect the flap linkage to the servo and the flap control horn. With the flap servo centered, adjust the linkage to achieve the mid-flap position as shown.

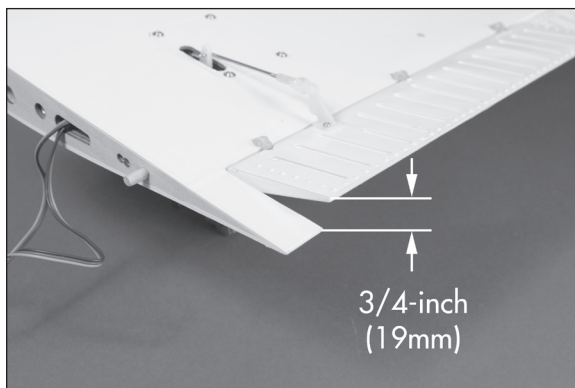

- 24. Next, set the full-flap position. Use the travel adjustment to set the down flap position as shown.

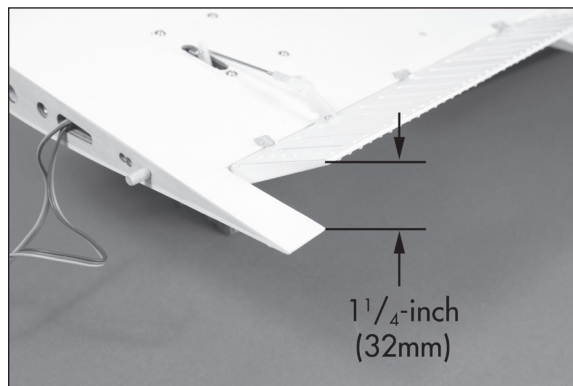

- 25. Set the flap switch to the up flap position. Use the travel adjustment to move the servo so the trailing edge of the flap is aligned with the trailing edge of the wing.

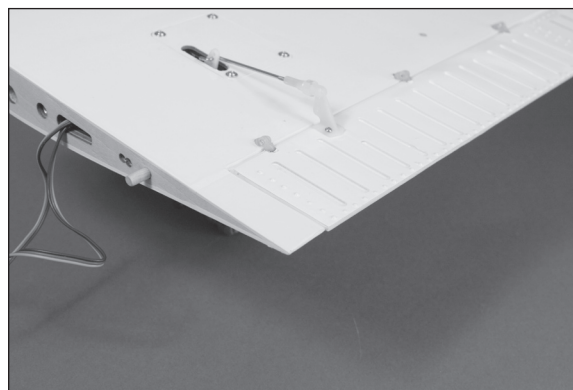

- 26. Repeat steps 23 through 25 for the flap servo.

- 27. Use canopy glue to attach the scale aileron linkage cover to the top of the wing. Position the cover so it is centered along the width of the aileron. The cover will rest 3/4-inch (19mm) forward of the hinge line as shown. Use low-tack tape to hold the cover in position until the glue fully cures. Install both covers at this time.

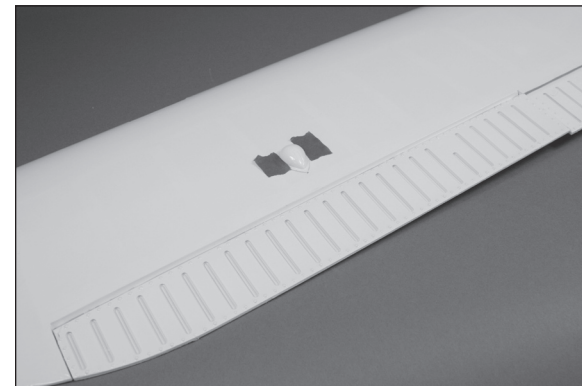

## Motor and Speed Control Installation

### Required Parts

Fuselage Motor with hardware  
4-40 x 3/4-inch socket head cap screw (4)  
Aluminum spacer, 3/8-inch (9.5mm) (4)  
Speed control  
Servo extension, 9-inch (228mm)

### Required Tools and Adhesives

Threadlock Phillips screwdriver: #1  
Dental floss Hex wrench: 3/32-inch

**E-tips**

Always use threadlock on metal-to-metal fasteners to prevent them from vibrating loose.

- 1. Attach the X-mount to the motor using the hardware included with the motor and a #1 Phillips screwdriver.

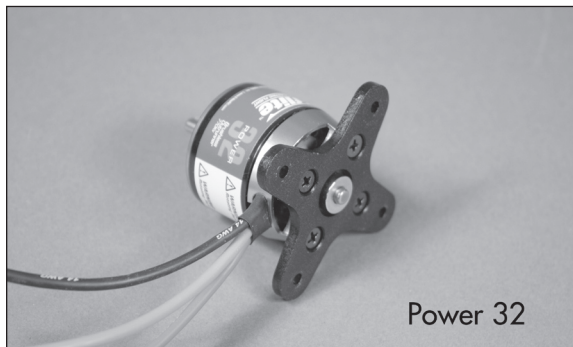
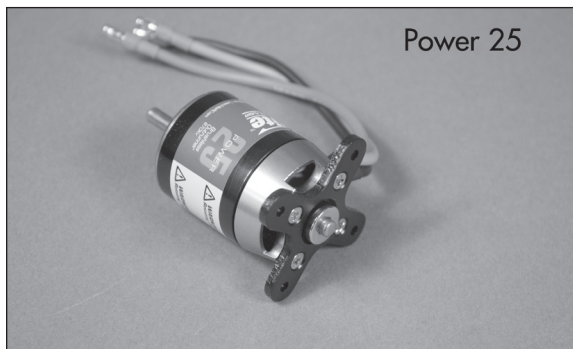

**E-tips**

Always use threadlock on metal-to-metal fasteners to prevent them from vibrating loose.

- 2. (Power 25) Secure the motor to the firewall using the four 4-40 x 3/4-inch socket head cap screws. Use a 3/32-inch hex wrench to tighten the screws. Make sure to use threadlock on these screws to prevent them from vibrating loose.

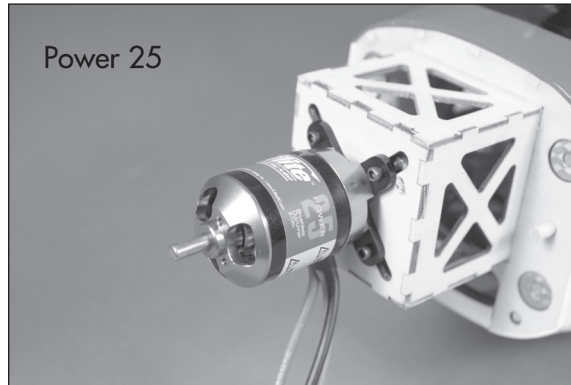

- 2. (Power 32) Secure the motor to the firewall using the four 3/8-inch (9.5mm) aluminum motor standoffs and four 4-40 x 3/4-inch socket head cap screws. Use a 3/32-inch hex wrench to tighten the screws. Make sure to use threadlock on these screws to prevent them from vibrating loose.

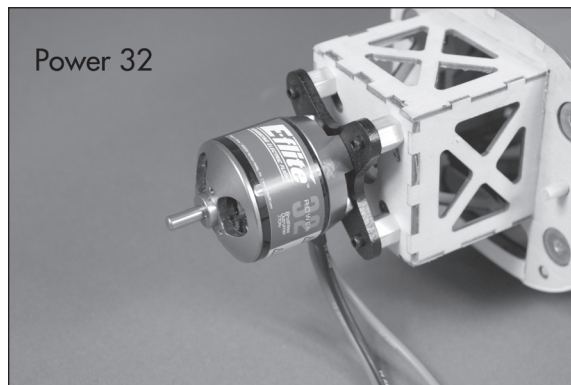

- 3. Remove the battery hatch by lifting it at the rear. The rear is held in position with magnets, while the front is held in position with dowels.

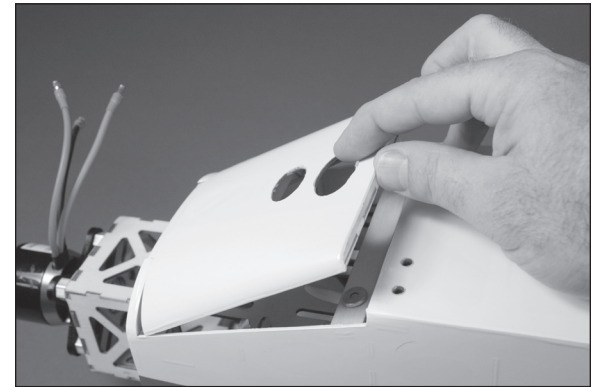

**E-tips**

Matching the colors between the ESC and motor when they are connected results in the correct motor direction if using all E-flite components.

- 4. Connect the leads from the motor to the speed control. Once connected, position the leads in the fuselage to prevent them from interfering with the operation of the motor or battery installation.

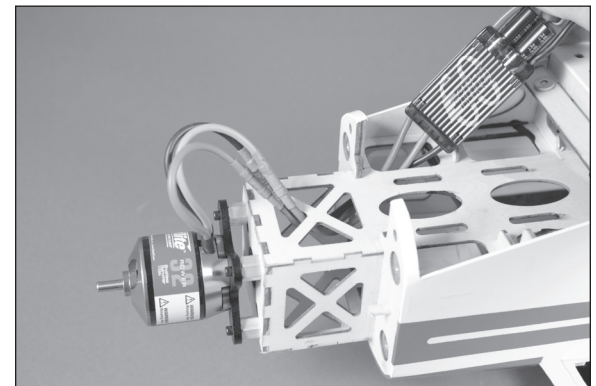

- 5. Place the speed control in the fuselage. Use two-sided tape to secure the speed control in the fuselage so it rests against the landing gear mount.

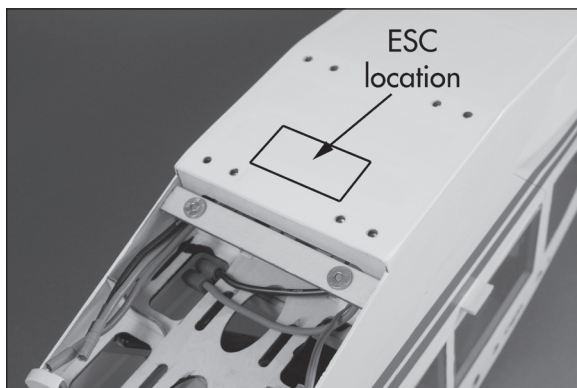

- 6. Connect a 9-inch (228mm) servo extension to the speed control lead. Use a string or piece of dental floss to secure the lead so it does not accidentally disconnect inside the fuselage.

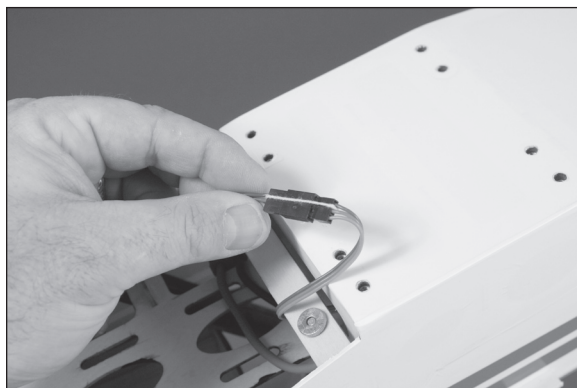

- 7. Mount the switch in the fuselage using the hardware provided with the speed control.



- 8. Guide the extension along the bottom inside the fuselage. Run the extension back as far as it will go. Use low-tack tape to prevent the extension from falling forward in the fuselage until it is plugged into the mounted receiver.



## Cowling, Propeller and Flight Battery Installation

### Required Parts

Fuselage assembly	Cowl
Propeller	Spinner assembly (not included)
Motor battery	Hook and loop strap
Hook and loop tape	

### Required Tools and Adhesives

Box wrench: 10mm  
Hex wrench: 3/32-inch

- 1. Slide the cowling on the fuselage. The dowels in the fuselage will position the cowl and the magnets will hold the cowl to the fuselage.

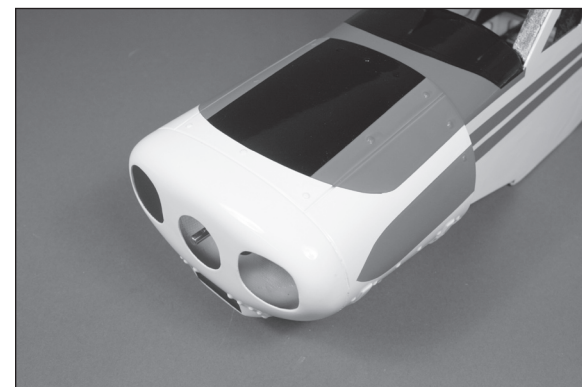
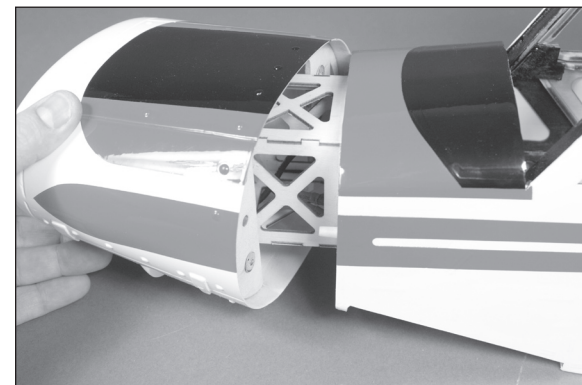

## ***Etips***

Always balance your propeller. An unbalanced propeller can cause vibrations to be transmitted into the airframe, which could damage the airframe or other components as well as produce unwanted flight characteristics.

## ***Etips***

We recommend using the optional spinner to enhance the looks of your model.

- 2. Slide the propeller/spinner on the motor shaft. Use a 10mm box wrench to tighten the nut securing the assembly to the motor shaft.

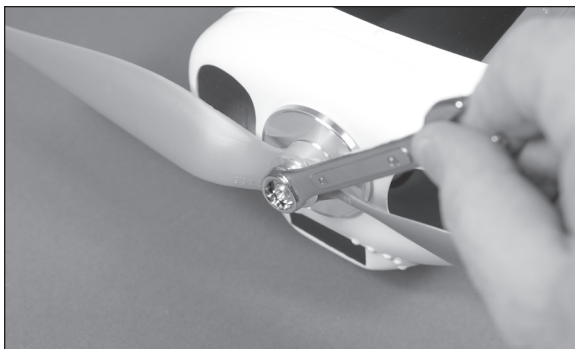

- 3. Place the spinner cone on the propeller. Use the screw included with the spinner assembly and a 3/32-inch hex wrench to secure the cone in position. Make sure the propeller is centered in the openings so the spinner does not rub against the prop blades, which could potentially cause them to fail.

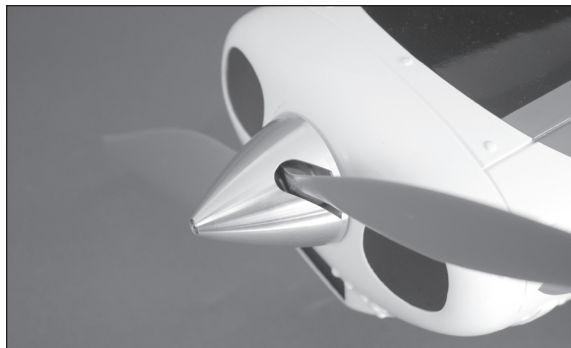

- 4. Secure the motor battery in the fuselage using a hook and loop strap. We recommend using hook and loop tape between the battery and battery tray to keep the battery from sliding on the tray during flight.



- 5. Place the battery hatch back into position on the fuselage.

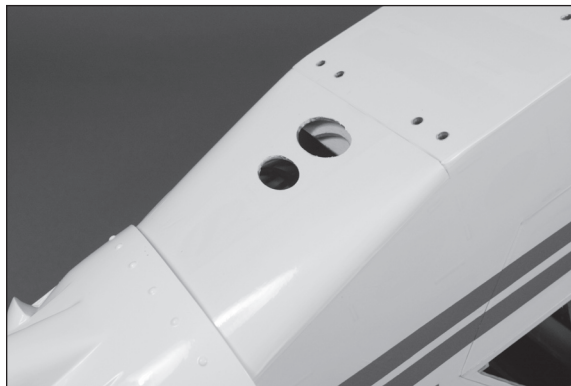

## ***Landing Gear Installation***

### ***Required Parts***

Fuselage assembly    Landing gear mount (4)  
Wing strut tab (2)    Landing gear leg (right and left)  
4-40 lock nut (10)    Axle (2)  
Silicone tubing (4)    Landing gear shock (2)  
6-32-inch setscrew (2)  
Main wheel, 3.35-inch (85mm) with hub (2)  
2mm x 15mm self-tapping screw (8)  
5/32-inch wheel collar with setscrew (2)  
4-40 x 5/8-inch socket head cap screws (8)  
4-40 x 1/2-inch socket head cap screw (2)  
6-32 x 1/2-inch socket head cap screw (8)  
Landing gear spreader

### ***Required Tools and Adhesives***

Hex wrench: 1.5mm, 3/32-inch, 5/64-inch,  
1/8-inch  
Flat blade screwdriver  
Nut driver: 1/4-inch  
Phillips screwdriver: #1  
Threadlock

## ***Etips***

Always use threadlock on metal-to-metal fasteners to prevent them from vibrating loose.

- 1. Place the wing strut tabs between the rear landing gear mounts and fuselage. Make sure the angle on the tab faces toward the top of the fuselage. Secure the four landing gear mounts and the two wing strut tabs to the fuselage using eight 6-32 x 1/2-inch socket head cap screws and a 1/8-inch hex wrench. Leave the screws loose so the mounts can be positioned when installing the landing gear legs.

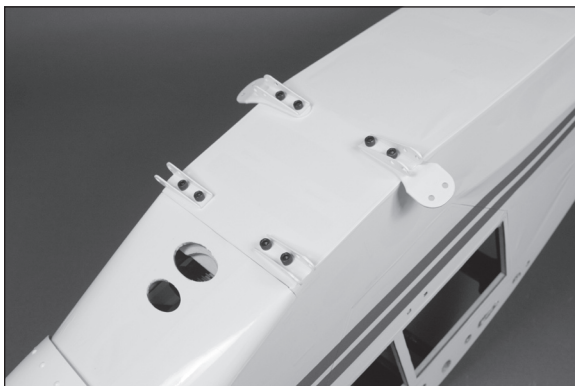

- 2. Attach the landing gear legs to the landing gear mounts using four 4-40 x 5/8-inch socket head cap screws and four 4-40 lock nuts. Use a 3/32-inch hex wrench and 1/4-inch nut driver to tighten the hardware. Do not over-tighten the hardware and prevent the landing gear from moving. Once the gear is in position, use a 1/8-inch hex wrench to fully tighten the hardware securing the landing gear mounts to the fuselage.



- 3. Attach the landing gear shocks to the landing gear spreader using two 4-40 x 1/2-inch socket head cap screws and two 4-40 lock nuts. Tighten the hardware using a 3/32-inch hex wrench and a 1/4-inch nut driver. Do not over-tighten the hardware, preventing the shocks from moving freely where they are attached to the spreader.

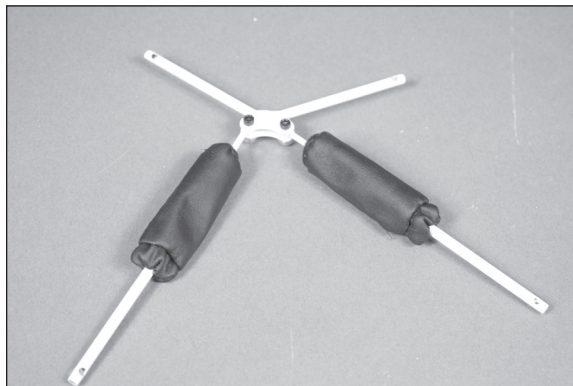

- 4. Attach the ends of the shocks to the front landing gear mount using two 4-40 x 5/8-inch socket head cap screws and two 4-40 lock nuts. Make sure to place a piece of silicone tubing on either side of the landing gear spreader to prevent the spreader from rubbing on the mounts. Tighten the hardware using a 3/32-inch hex wrench and a 1/4-inch nut driver. Do not over-tighten the hardware, as it could prevent the shocks from moving freely where they are attached to the landing gear mounts.



- 5. Attach the ends of the spreader to the landing gear using two 4-40 x 5/8-inch socket head cap screws and two 4-40 lock nuts. Tighten the hardware using a 3/32-inch hex wrench and a 1/4-inch nut driver. Do not over-tighten the hardware, as it could prevent the spreader from moving freely where it is attached to the landing gear.

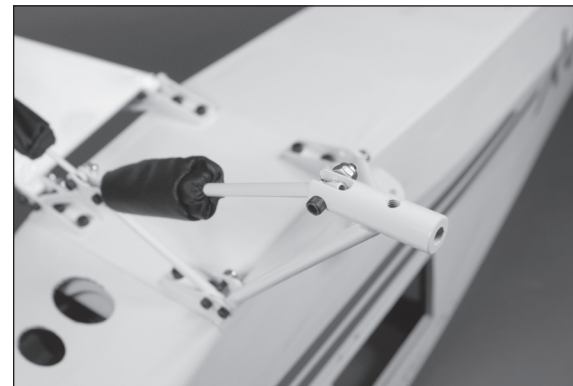

- 6. Remove the hub cap from the wheel using a flat blade screwdriver. Use care not to damage the hub cap or hub. Remove the outer hub from the wheel at this time as well.

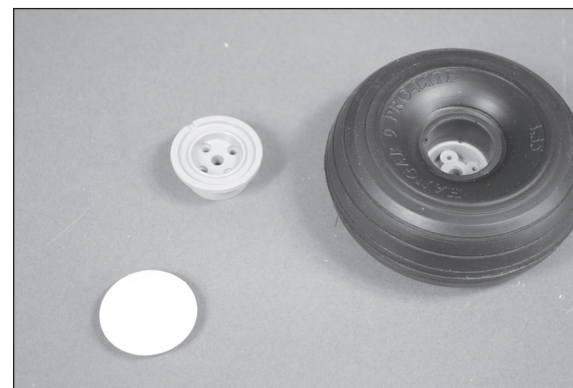



## ***E-tips***

Always use threadlock on metal-to-metal fasteners to prevent them from vibrating loose.

- 7. Use a 1.5mm hex wrench to tighten the setscrew securing the 5/32-inch wheel collar to the flat on one end of the axle.

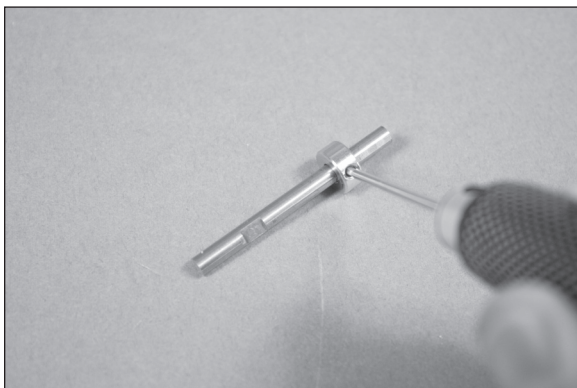

- 8. Slide the axle through the inner hub in the wheel.



The inner hub is the one without the holes for the screws to pass through.

- 9. Press the outer hub into the tire, aligning the holes in the outer hub with those in the inner hub. Use a #1 Phillips screwdriver to install the four 2mm x 15mm self-tapping screws that secure the hubs together. Use care in positioning the hubs so the screws are threaded into the holes in the inner hub.



- 10. Slide the axle into the landing gear. Use a 5/64-inch hex wrench to tighten a 6/32-inch setscrew onto the flat on the axle. Make sure the wheel can rotate freely on the axle.

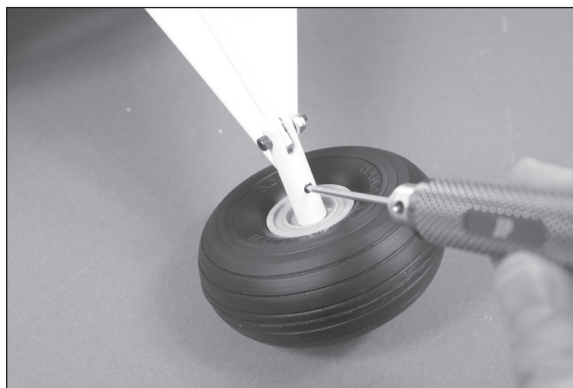

- 11. Snap the hub cap on the wheel as shown.



## ***E-tips***

Use a permanent marker to carefully color the embossed Cub text on the hub cap for further scale effect.

- 12. Repeat steps 6 through 11 to install the remaining axle and wheel.

## Stabilizer and Tail Bracing Installation

### Required Parts

Fuselage assembly Stabilizer (right and left)  
2-56 x 6<sup>1</sup>/<sub>2</sub>-inch threaded rod (2)  
2-56 x 6<sup>3</sup>/<sub>4</sub>-inch threaded rod (2)  
4-40 x 5/8-inch socket head cap screw (3)  
4-40 x 1/4-inch socket head cap screw (2)  
4-40 lock nut (3) Nylon brace end (8)  
Carbon rod, 5<sup>1</sup>/<sub>8</sub>-inch (130mm)  
Carbon rod, 3<sup>9</sup>/<sub>16</sub>-inch (90mm)

### Required Tools and Adhesives

Pin vise Drill bit: 7/64-inch (3mm)  
Threadlock Hex wrench: 3/32-inch  
Toothpick Nut driver: 1/4-inch  
30-minute epoxy Paper towel  
Isopropyl alcohol Square  
Sandpaper

- 1. Slide the carbon fiber rods into the sockets in the horizontal stabilizer. The longer 5<sup>1</sup>/<sub>8</sub>-inch (130mm) rod is placed toward the front, while the shorter 3<sup>9</sup>/<sub>16</sub>-inch (90mm) rod is positioned toward the trailing edge. There are caps in the ends of the sockets for the carbon rod spars. Do not force them in any farther than they will easily slide.

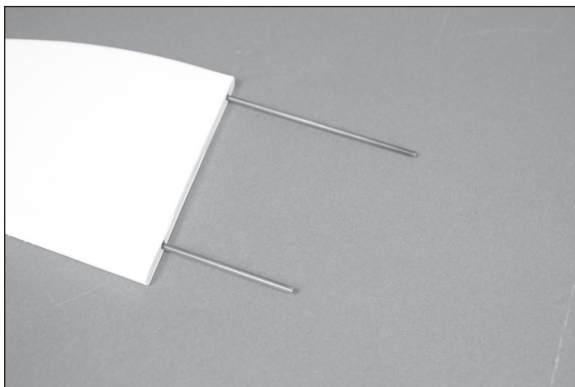

- 2. Slide the stabilizer into position, guiding the carbon rods through the holes in the fuselage. Slide the stabilizer so it is tight against the fuselage.

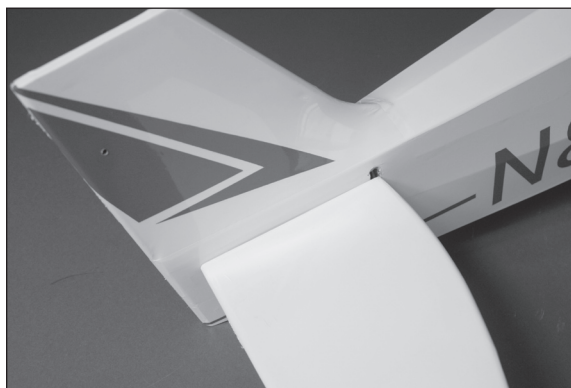

- 3. Test the fit of the remaining stabilizer on the stabilizer rods. Both stabilizers must fit snug against the fuselage as shown. If not, determine the problem and correct it before proceeding. Do not assume that the rods are too long and shorten them. The stabilizer relies on these for structural integrity.



- 4. Once the fit has been checked, remove the stabilizers and carbon rods. Use sandpaper to lightly sand each of the carbon rods. Mix a small amount of 30-minute epoxy. Use a toothpick to apply the epoxy in the holes for the carbon rods in both stabilizer halves and the fuselage. Place the stabilizers and carbon rods back into position and allow the epoxy to fully cure before attaching the bracing. Remove any excess epoxy before it cures using a paper towel and isopropyl alcohol.

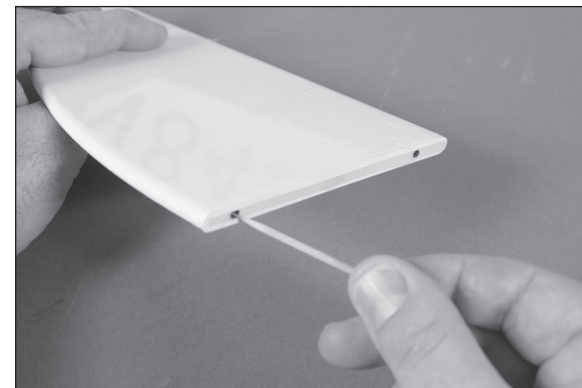

- 5. Use a pin vise and 7/64-inch (3mm) drill bit to enlarge the hole in the eight nylon brace ends.

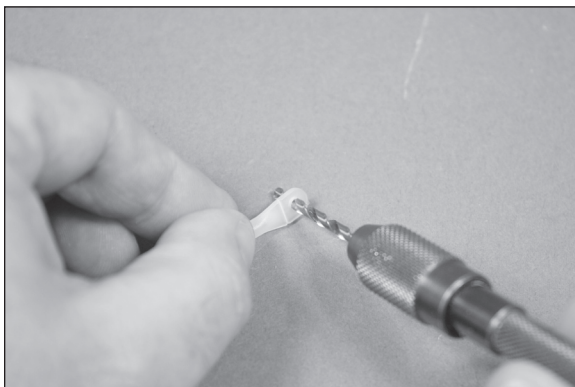

- 6. Thread the nylon ends on the two 2-56 x 6<sup>1</sup>/<sub>2</sub>-inch threaded rods and the two 2-56 x 6<sup>3</sup>/<sub>4</sub>-inch threaded rod.

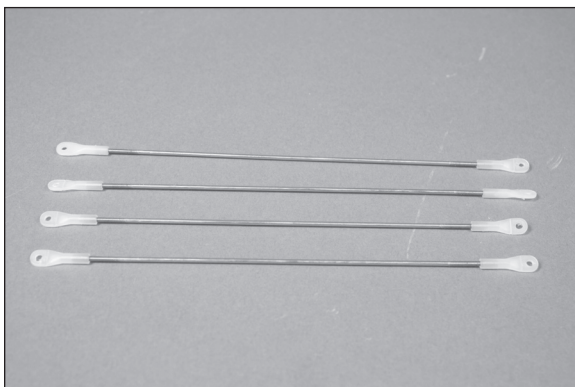

- 7. Attach the nylon ends to the stabilizer using two 4-40 x 5/8-inch socket head cap screws and two 4-40 lock nuts. Use a 3/32-inch hex wrench and 1/4-inch nut driver to tighten the hardware. Leave the hardware slightly loose so the rods can be positioned.

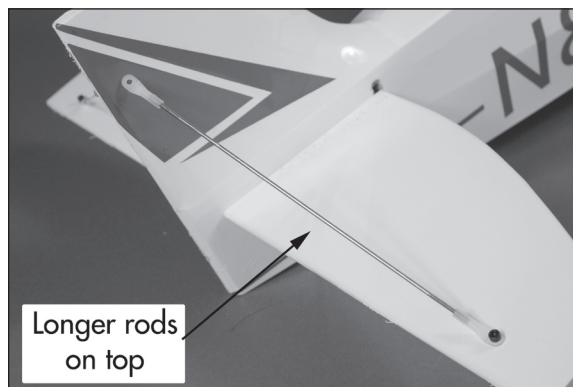

**Important:** The shorter 2-56 x 6<sup>1</sup>/<sub>2</sub>-inch threaded rods are located on the bottom of the stabilizer, and the shorter 2-56 x 6<sup>3</sup>/<sub>4</sub>-inch threaded rods are located on the top of the stabilizer.

### **E-tips**

Always use threadlock on metal-to-metal fasteners to prevent them from vibrating loose.

### **E-tips**

When installing the rods, make sure they are in tension with one another slightly. This is what gives the tail bracing its strength. Nothing should be warped, and the anchor points are the two attach points in the bottom of the fuselage. The fin should not bend to one side and the stab should remain flat. This may take some adjustment to get right.

- 8. Adjust the position of the nylon ends so the holes align with the holes in the fuselage. Use a square to make sure the stabilizer isn't being overly-forced into position. Use a 4-40 x 1/4-inch socket head screw and a 3/32-inch hex wrench to install the screws, securing the ends to the fuselage.



- 9. The upper rods are attached to the fin using a 4-40 x 5/8-inch socket head cap screw and 4-40 locknut. Thread the nylon ends in or out as necessary to set the length of the rods. Use a square to check that the stabilizer remains square to the fin on both the top and bottom of the fuselage.

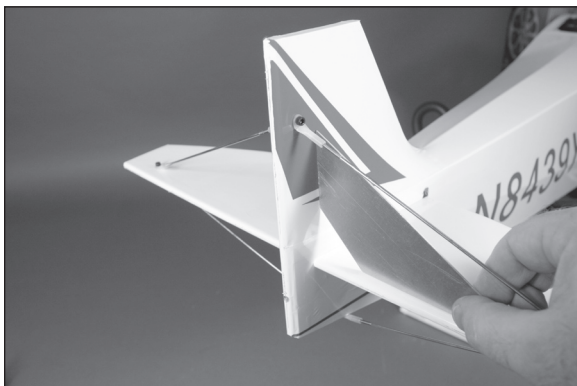

## Elevator Installation

### Required Parts

Fuselage assembly CA hinge (6)  
 Elevator (2) Control horn (2)  
 2mm x 8mm self-tapping screw (4)

### Required Tools and Adhesives

Thin CA Phillips screwdriver: #1  
 Pin vise Drill bit: 1/16-inch (1.5mm)  
 T-pins

- 1. Use a pin vise and 1/16-inch (1.5mm) drill bit to drill a hole in the center of each hinge slot in the elevator and stabilizer to create a tunnel for the CA to wick into. This will allow the CA to penetrate the hinge, creating a better bond between the hinge and surrounding wood.

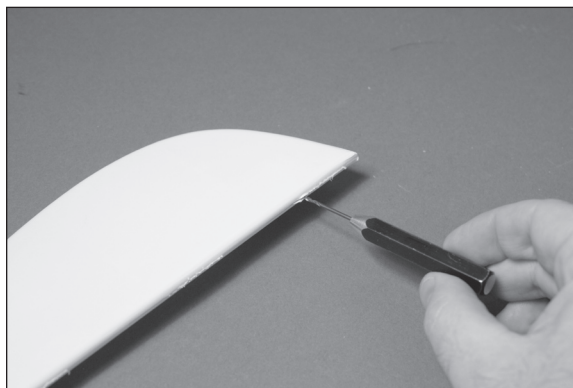

- 2. Remove the control horn backplate from the control horn using a hobby knife and #11 blade. The backplate can be discarded as it is not used in the assembly of your model.

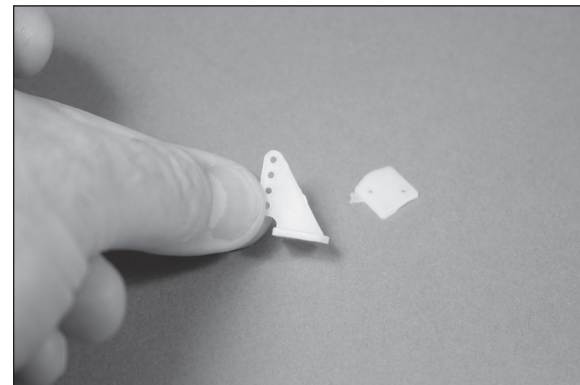

- 3. Use a #1 Phillips screwdriver to thread a 2mm x 8mm self-tapping screw into each of the pre-drilled holes to cut threads in the surrounding wood. Remove the screw before moving to the next step.



- 4. Apply 2–3 drops of thin CA in each of the holes to harden the surrounding wood. This will harden the threads so the screws do not easily strip the surrounding wood.



- 5. Install the control horn using two 2mm x 8mm self-tapping screws and a #1 Phillips screwdriver.

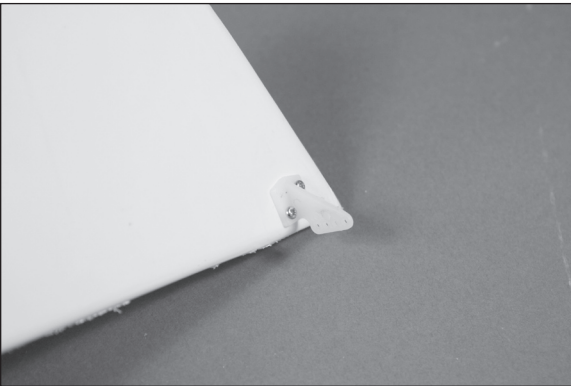

- 6. Place a T-pin in the center of each of the three hinges. This will center the hinges equally in the elevator and stabilizer when they are installed.

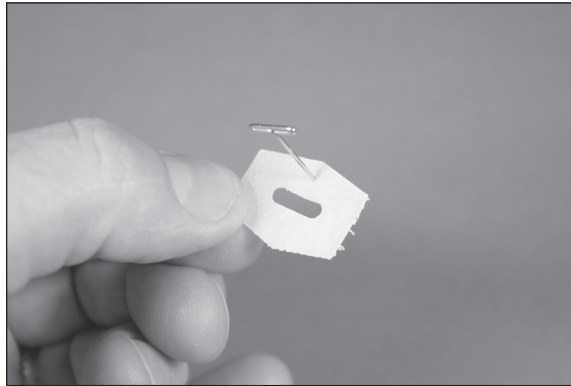

- 7. Insert the hinges in the elevator. The T-pin will rest on the edge of the elevator bevel.

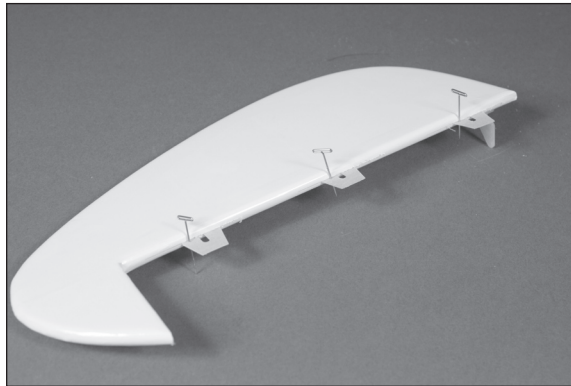

- 8. Slide the elevator into position, guiding the hinges into the slots in the stabilizer. Make sure the elevator is installed so the control horn is facing down.

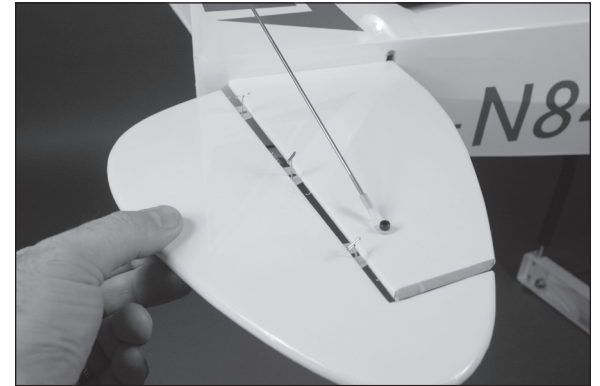

- 9. Remove the t-pins from the hinges and slide the elevator tightly against the stabilizer. Check that the elevator can move without rubbing the stabilizer at the counter balance.



- 10. Saturate each hinge with thin CA. Apply CA to both the top and bottom of the hinge.



- 11. Once the CA has cured, gently pull on the control surface and stabilizer to make sure the hinges are glued securely. If not, apply CA to those hinges that are not glued and recheck.



- 12. Move the control surface through its range of motion several times to break in the hinges. This will reduce the initial load on the servo during your first flights.

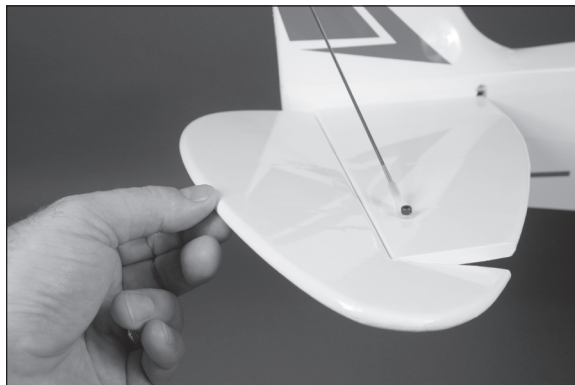

- 13. Repeat steps 1 through 12 to install the other elevator half.

## Rudder Installation

### Required Parts

Fuselage assembly	CA hinge (3)
Control horn	Rudder tiller arm (2)
2mm nut	2mm x 12mm machine screw
	2mm x 8mm self-tapping screw (2)

### Required Tools and Adhesives

Thin CA	Phillips screwdriver: #1
Pin vise	Drill bit: 1/16-inch (1.5mm)
T-pins	Hobby knife with #11 blade

### Optional Lighting Items

Clear LED light	Soldering iron
Heat shrink	36-inch lighting extension

### *E-tips*

The steps in the grey boxes are steps specific to the lighting kit. If you will not be installing the lighting kit you can skip the steps in the grey boxes.

- 1. Use a pin vise and 1/16-inch (1.5mm) drill bit to drill a hole in the center of each hinge slot in the rudder and fin to create a tunnel for the CA to wick into. This will allow the CA to penetrate the hinge, creating a better bond between the hinge and surrounding wood.

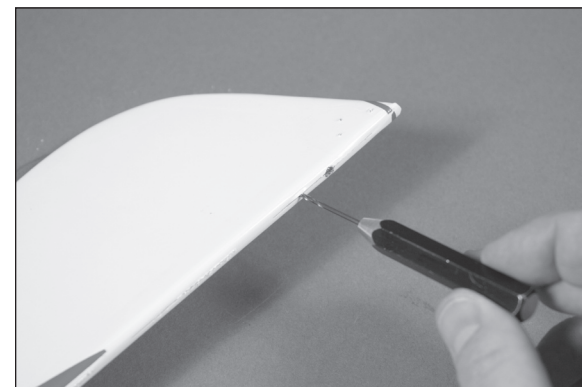

- A. If you are installing the lighting kit, make sure to remove the covering from the tube in the rudder using a hobby knife and #11 blade.

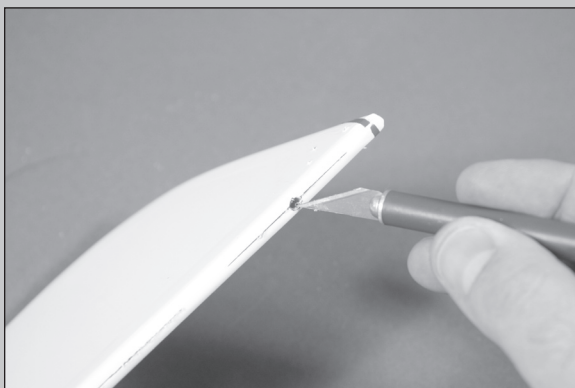

- 2. Use a #1 Phillips screwdriver to thread a 2mm x 8mm self-tapping screw into each of the pre-drilled holes to cut threads in the surrounding wood. Remove the screw before moving to the next step.

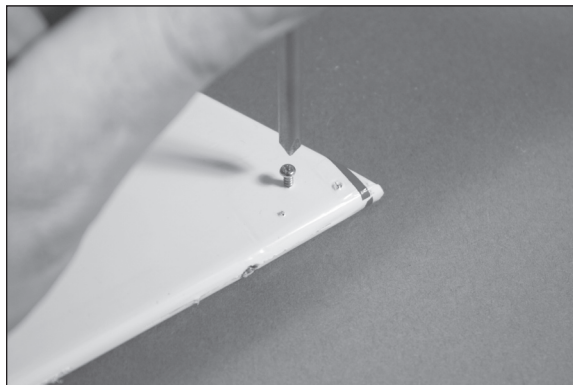

- 3. Apply 2-3 drops of thin CA in each of the holes to harden the surrounding wood. This will harden the threads so the screws do not easily strip the surrounding wood.



- 4. Remove the control horn backplate from the control horn using a hobby knife and #11 blade. The backplate can be discarded as it is not used in the assembly of your model.

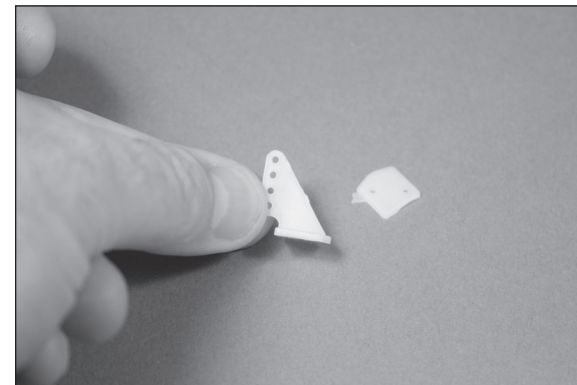

- 5. Install the control horn using two 2mm x 8mm self-tapping screws and a #1 Phillips screwdriver.



***Etips***

Always use threadlock on metal-to-metal fasteners to prevent them from vibrating loose.

- 6. Attach the rudder tiller arms using a 2mm x 12mm machine screw and 2mm nut. Position the tiller arms so they face toward the bottom of the rudder and forward towards the hinge line as shown.

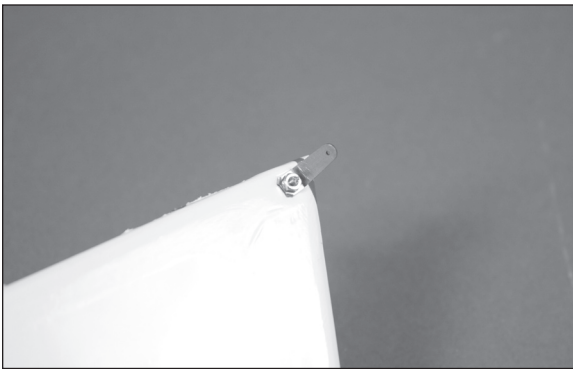
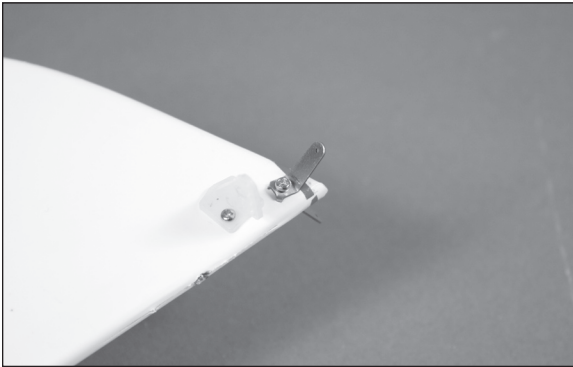

- 7. Place a T-pin in the center of each of the three hinges. This will center the hinges equally in the aileron and wing when they are installed.

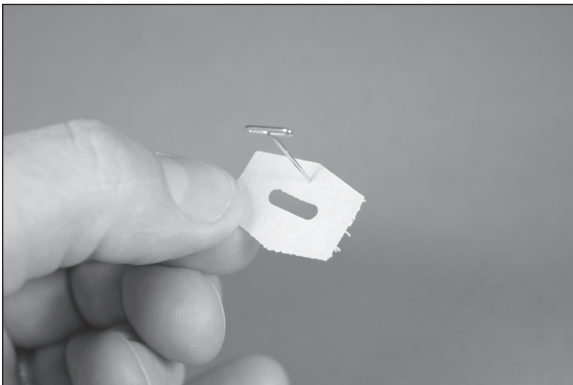

- 8. Insert the hinges in the rudder. The T-pin will rest on the edge of the rudder bevel.

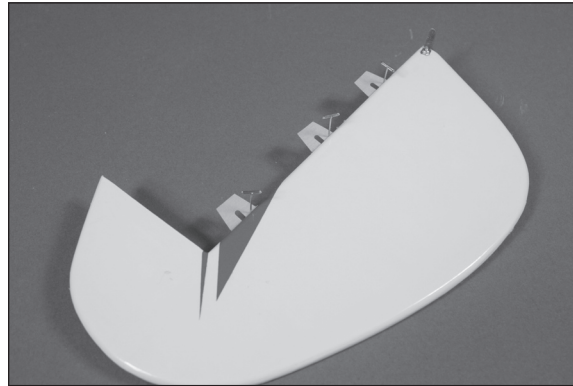

- B. Use side cutters to remove the plug from the clear light. Check the fit of the light in the tube in the rudder. It may be necessary to use a hobby knife and #11 blade to remove some material from the rudder to make the light fit flush to the trailing edge of the rudder. Remove the light once the fit has been made.

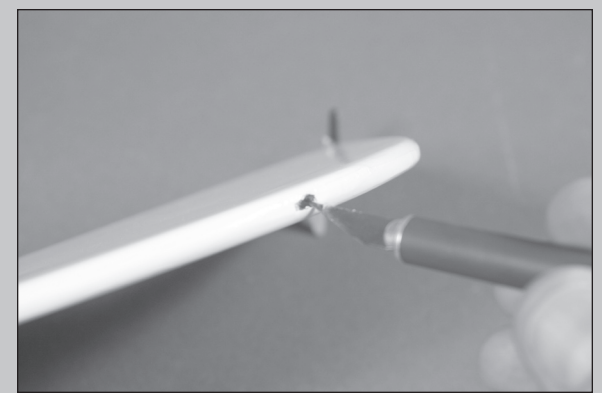

- C. Remove the end of the 36-inch (915mm) lighting extension. Make sure the end that remains is the end that plugs into the lighting controller. Slide the extension through the tube in the fuselage and out at the rudder hinge line.





- D. The wire can now be passed through the tube in the rudder. Proceed with hinging the rudder.

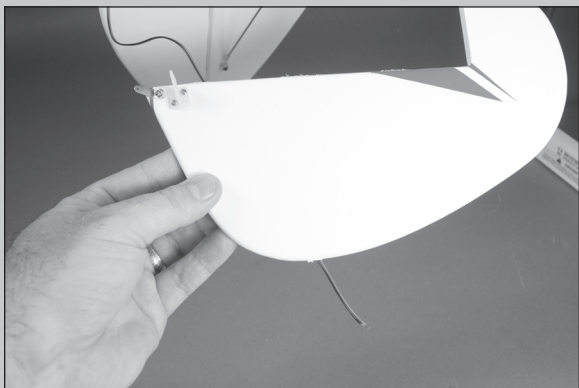

- 9. Slide the rudder into position, guiding the hinges in the slots in the fin. Remove the T-pins from the hinges and slide the rudder tightly against the fin. Check that the rudder can move without rubbing the fin at the counter balance.



- 10. Saturate each hinge with thin CA. Apply CA to both the sides of the hinge.



- 11. Once the CA has cured, gently pull on the control surface and fin to make sure the hinges are glued securely. If not, apply CA to those hinges that are not glued and recheck.



- 12. Move the control surface through its range of motion several times to break in the hinges. This will reduce the initial load on the servo during your first flights.

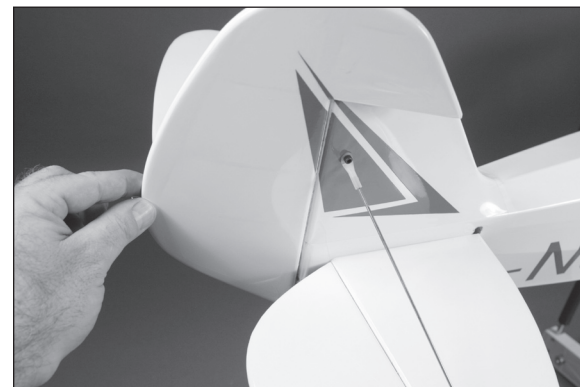
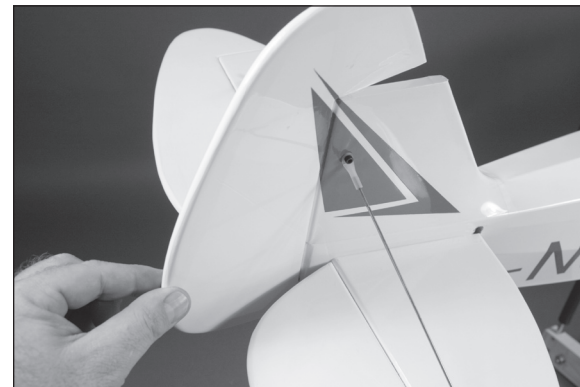

- E. Carefully solder the extension to the light. Use care not to melt the wiring by leaving the soldering iron in position too long. Make sure to stagger the solder joint so the wires will fit into the tube in the rudder. Use heat shrink tubing to protect the connections.

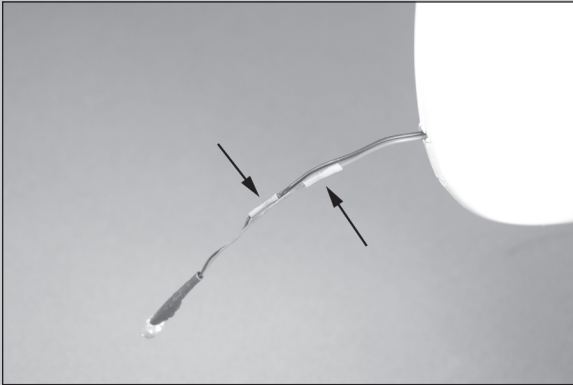

- F. Press the light into position in the rudder. It may be necessary to use a very small amount of silicone adhesive to keep the light in position.

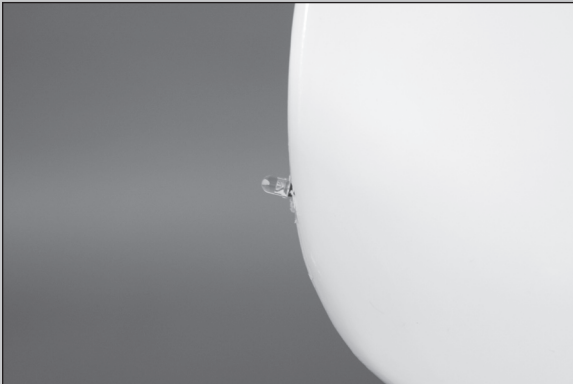

## Tail Wheel Installation

### Required Parts

Fuselage assembly Tail wheel bracket  
 Tail wheel spring (2)  
 2mm x 10mm washer head self-tapping screw (2)

### Required Tools and Adhesives

Thin CA Phillips screwdriver: #1  
 Pliers Ruler  
 Side cutters

- 1. Use a #1 Phillips screwdriver to thread a 2mm x 10mm washer-head self-tapping screw into each of the holes to cut threads in the surrounding wood. Remove the screw before moving to the next step.



- 2. Apply 2–3 drops of thin CA in each of the holes to harden the surrounding wood. This will harden the threads so the screws do not easily strip the surrounding wood.



- 3. Install the tail wheel bracket using two 2mm x 10mm washer-head self-tapping screws and a #1 Phillips screwdriver.



- 4. Use side cutters to remove the flat portion of the springs. Use pliers to bend the outermost coil at each end 90 degrees outward to form a hook.



- 5. Install the spring between the ruder tiller arm and the steering tiller arm, attaching it to the center hole in the steering arm.

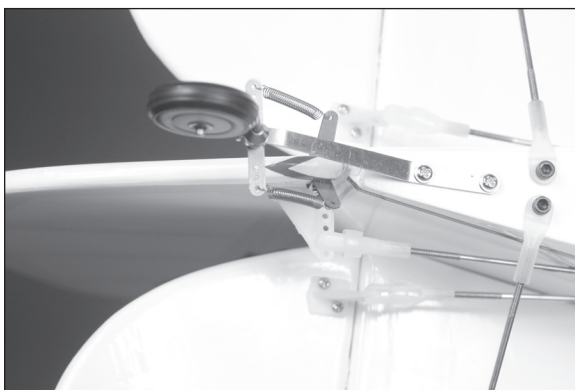

- 6. Repeat steps 4 and 5 to install the remaining tail wheel spring.

## **Rudder and Elevator Servo and Linkage Installation**

### **Required Parts**

Fuselage assembly	Servo with hardware (2)
Rudder pushrod	Elevator pushrod
Nylon clevis (3)	Safety tubing (3)
Transmitter	Receiver
Receiver battery	

### **Required Tools and Adhesives**

Thin CA	Phillips screwdriver: #1
Pin vise	Drill bit: 5/64-inch (2mm)
Ruler	

- 1. Remove the tape holding the servo hatch cover on the fuselage. Set the cover aside. You may need to use a covering iron to reseal the covering to the fuselage if the tape lifts the covering.



- 2. Use a #1 Phillips screwdriver to thread a servo mounting screw into each of the holes to cut threads in the surrounding wood. Remove the screw before moving to the next step. Use care not to press too hard and damage the servo plate.



- 3. Apply 2-3 drops of thin CA in each of the holes to harden the surrounding wood. This will harden the threads so the screws do not easily strip the surrounding wood.

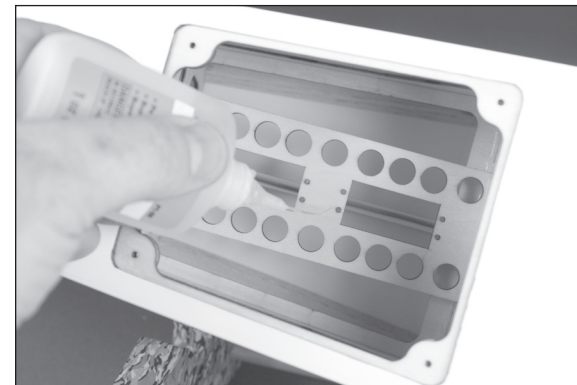

- 4. Prepare the rudder and elevator servo by installing the servo grommets and brass eyelets.

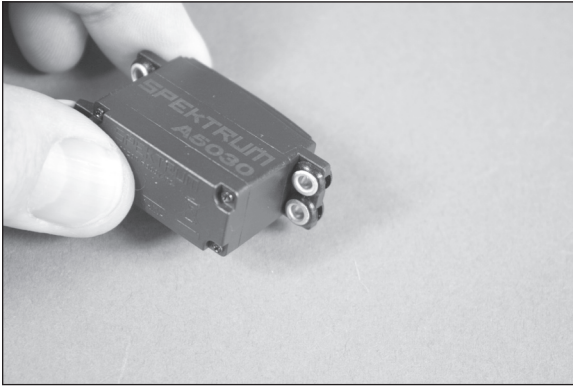

- 5. Install the rudder and elevator servos using eight servo mounting screws and a #1 Phillips screwdriver.

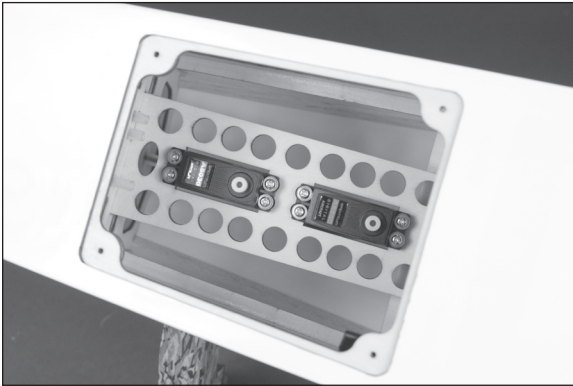

- 6. Insert the rudder pushrod into the tube in the fuselage. It is easiest to start from outside the fuselage when inserting the pushrod.

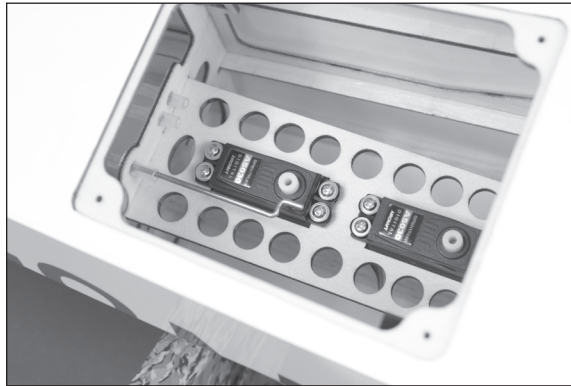

- 7. Slide the small piece of tubing in a nylon clevis. Thread the clevis 12-turns on the rudder pushrod wire. This will provide enough thread in the clevis to be secure and allow for adjustment of the linkage. Connect the clevis to the hole shown in the drawing.

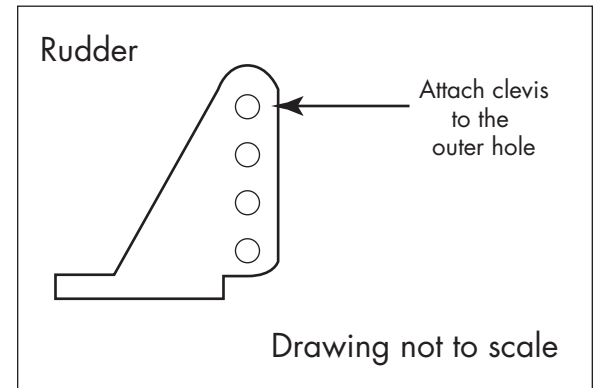

- 8. Use a pin vise and 5/64-inch (2mm) drill bit to enlarge the hole in the servo horn. Enlarge the hole that is 1/2-inch (13mm) from the center of the horn as shown. Use side cutters to remove any unused arms so they don't interfere with the operation of the servo.

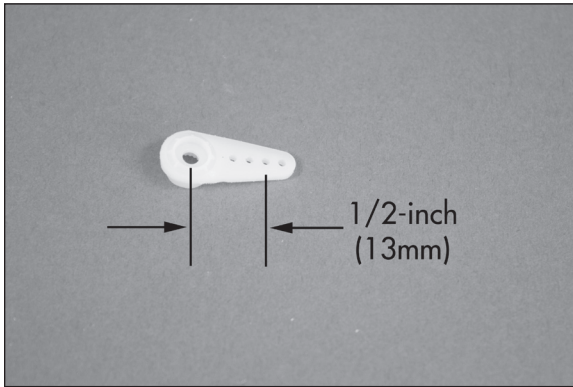

- 9. Pass the Z-bend in the pushrod through the hole enlarged in the previous step. With the servo centered, attach the servo horn to the servo using the screw provided with the servo and a #1 Phillips screwdriver.



- 10. Repeat steps 6 through 9 to install the elevator pushrod. Make sure to install a clevis for both elevator control horns

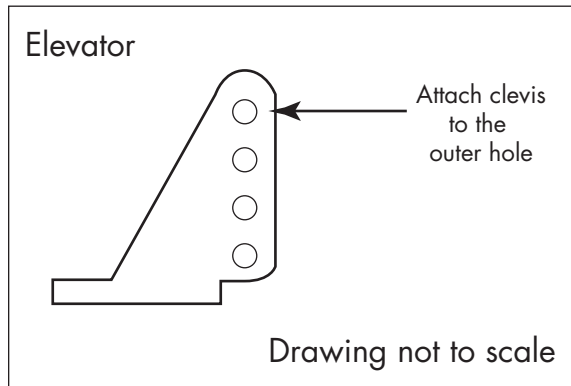

- 11. With the radio system on and the rudder and elevator servos centered, check that the control surfaces are aligned with the fixed surfaces. Use a ruler between the two surfaces. Adjust the clevis as necessary to align the surfaces. Once aligned, slide the silicone tubing over the forks of the clevis to prevent them from opening accidentally. Check both elevator and the rudder at this time.

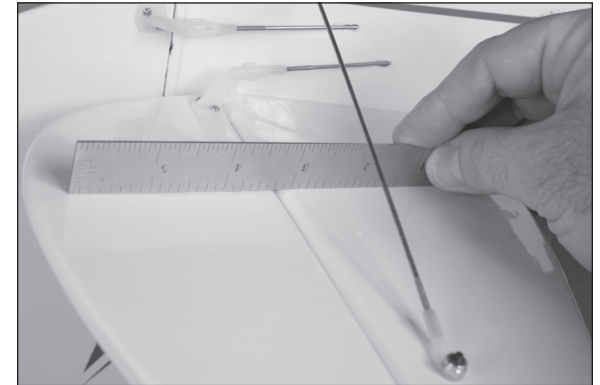

## Receiver Installation without Cockpit Kit

### Required Parts

Fuselage assembly Receiver  
Y-harness Hook and loop tape  
12-inch (305mm) servo extension (2)  
3-inch (76mm) servo extension

### Required Tools and Adhesives

Scissors

- 1. Use scissors to cut two small pieces of hook and loop tape the size of the receiver and remote receiver. Plug the rudder and elevator servos into the correct ports. Plug the 12-inch (305mm) extensions into the aileron and Aux 1 ports (this is used for differential aileron throw). Plug the Y-harness into the flap port. Plug the 3-inch extension (76mm) into the bind port. Secure the main and remote receivers in the fuselage using hook and loop tape.

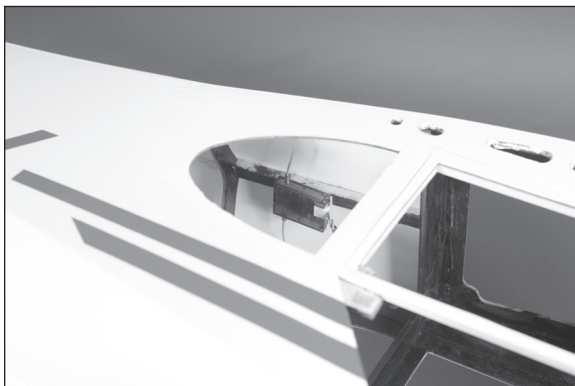

## Receiver Installation with Cockpit Kit

### Required Parts

Fuselage assembly Hook and loop tape  
12-inch (305mm) servo extension (2)  
3-inch (76mm) servo extension  
Y-harness  
Receiver mount plate (from cockpit kit)

### Required Tools and Adhesives

Scissors Medium CA

- 1. Locate the receiver mount plate in the cockpit kit. Use medium CA to glue the mount in the fuselage at the front of the servo mounting tray as shown.



- 2. 1. Use scissors to cut two small pieces of hook and loop tape the size of the receiver and remote receiver. Plug the rudder and elevator servos into the correct ports. Plug the 12-inch (305mm) extensions into the aileron and Aux 1 ports (this is used for differential aileron throw). Plug the Y-harness into the flap port. Plug the 3-inch extension (76mm) into the bind port. Secure the main and remote receivers in the fuselage using hook and loop tape.

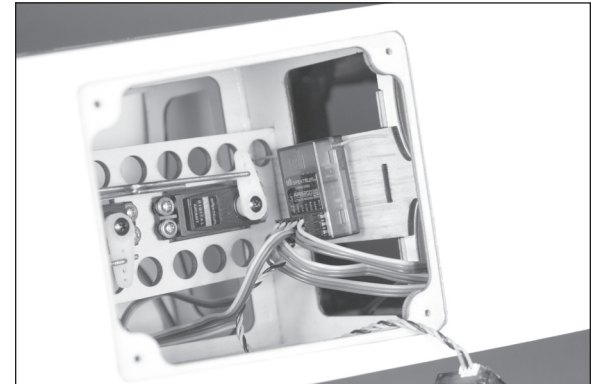

- 3. Cut a piece of hook and loop tape to attach the remote receiver to the fuselage side.

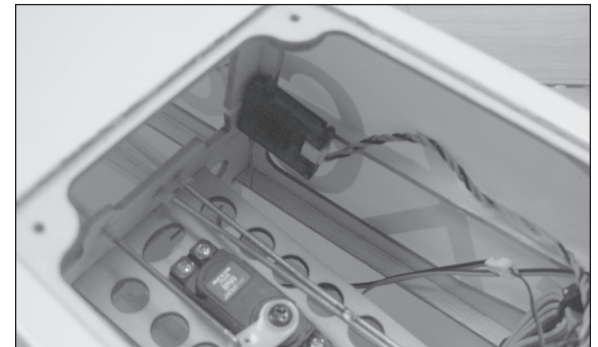

## Servo Hatch Cover Installation

### Required Parts

Fuselage assembly Servo hatch cover  
2.5mm x 8mm washer-head self-tapping screw (4)

### Required Tools and Adhesives

Thin CA Phillips screwdriver: #1

- 1. Route the servo leads for the ailerons and flaps outside the fuselage as shown.



- 2. Use a #1 Phillips screwdriver to thread a 2.5mm x 8mm washer-head self-tapping screw into each of the holes to cut threads in the surrounding wood. Remove the screw before moving to the next step.



- 3. Apply 2–3 drops of thin CA in each of the holes to harden the surrounding wood. This will harden the threads so the screws do not easily strip the surrounding wood.



- 4. Install the servo cover using four 2.5mm x 8mm washer-head self-tapping screws and a #1 Phillips screwdriver.



## Window and Seat Installation

### Required Parts

Fuselage assembly Instrument panel decal  
Windscreen Upper window  
Seat base (2) Seat (2)  
2mm x 8mm self-tapping screw (4)  
Side window, front (right and left)  
Side window, center (right and left)  
Side window, rear (right and left)  
Hardwood windscreen support (2)

### Required Tools and Adhesives

Thin CA Phillips screwdriver: #1  
Medium CA Canopy glue  
Scissors

- 1. Use scissors to cut the instrument panel from the decal sheet. Apply the decal in the fuselage.

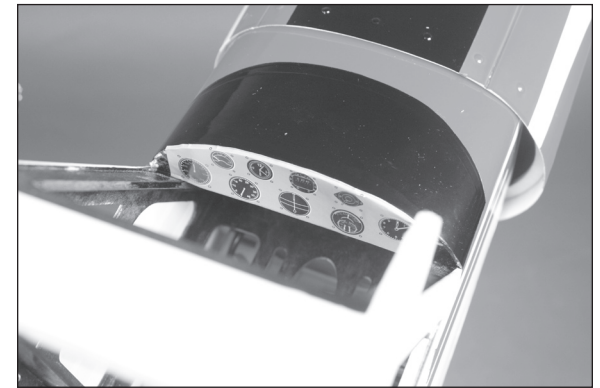

If you are installing the optional cockpit kit (EFL460018), you can skip step 1.

- 2. Test fit the hardwood windscreen supports into position. The supports fit tightly at the top corners of the windscreen frame and meet at the bottom as shown. Use medium CA to glue the supports in position.



- 3. Test fit the windows and windscreen into position in the fuselage. The side windows install from the inside of the fuselage. Apply a thin bead of canopy glue around the perimeter of the windows and windscreen. Use low-tack tape to hold them in position on the fuselage. Make sure the positioning of the windscreen does not interfere with the operation of the cockpit door.

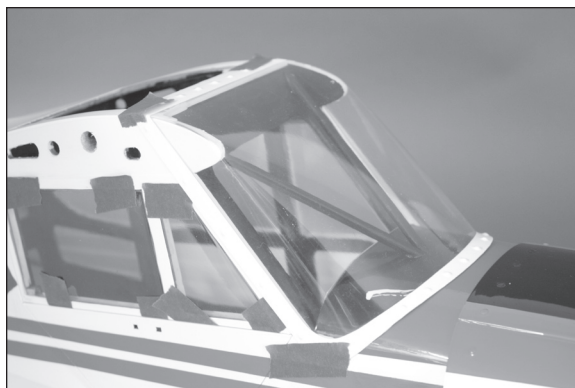

- 4. Use medium CA to glue the door handle in position.

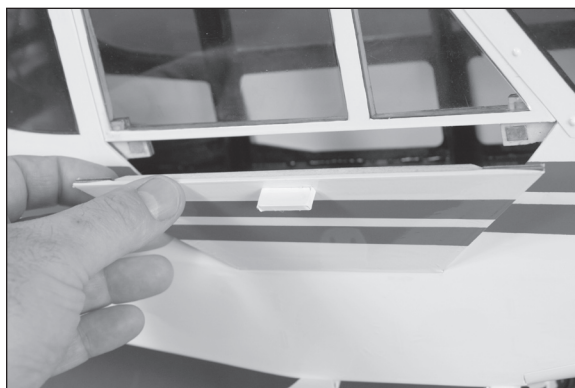

- 5. Use a #1 Phillips screwdriver to thread a 2mm x 8mm self-tapping screw into each of the holes to cut threads into the surrounding wood. Remove the screw before moving to the next step.



- 6. Apply 2-3 drops of thin CA in each of the holes to harden the surrounding wood. This will harden the threads so the screws do not easily strip the surrounding wood.



- 7. Install the upper window using four 2mm x 8mm self-tapping screws and a #1 Phillips screwdriver.



**Important:** If installing the optional scale cockpit, skip the installation of the upper window until the cockpit kit has been installed.



- 8. Use medium CA to glue the seat supports in the fuselage. Make sure the CA has fully cured before proceeding.

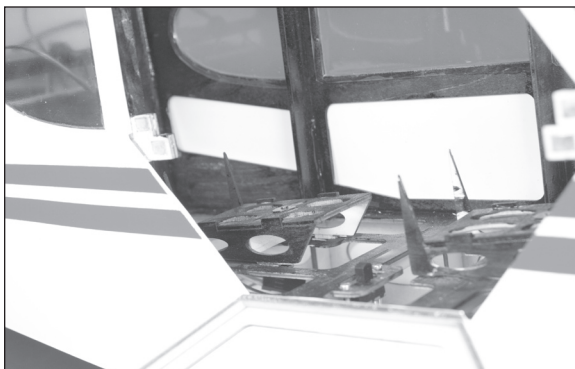
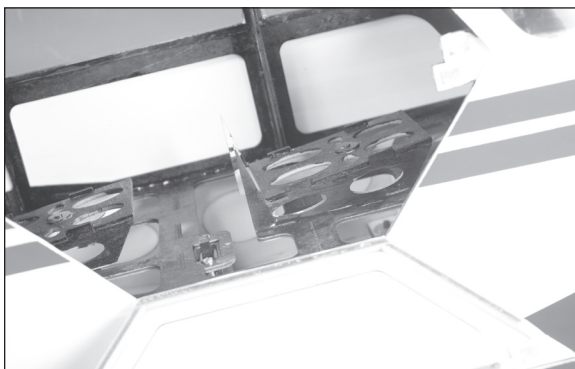

- 9. The seats are held in position with magnets so they can be removed when installing the wing bolts. Install the seats as shown. Please note that the prototype seats are shown; the production seats are darker in color.

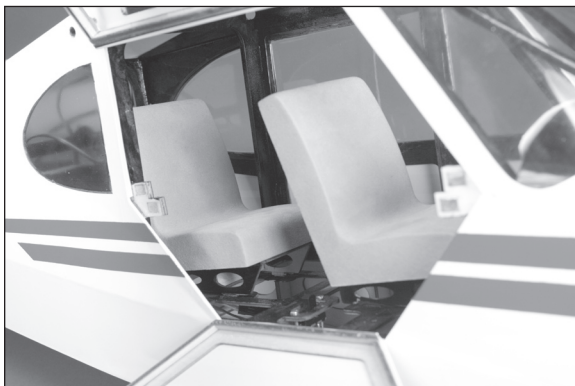

## Cockpit Kit Installation (Optional)

### Required Parts

Fuselage assembly    Cockpit kit (optional)

### Required Tools and Adhesives

Medium CA                  Two-sided tape

## *Etips*

You can use two-sided tape to secure the floor so it can be removed in the future, should a component need to be replaced or a repair to the airframe is necessary.

- 1. Test fit the pieces of the cockpit kit into the fuselage. Start by installing the thin plastic floor, then the thin painted side pieces. The covered wood side rails are then installed. Once these items have been fit, you can use medium CA to glue them in position in the fuselage. Finally, install the control stick, control pedals and instrument panel in the fuselage.

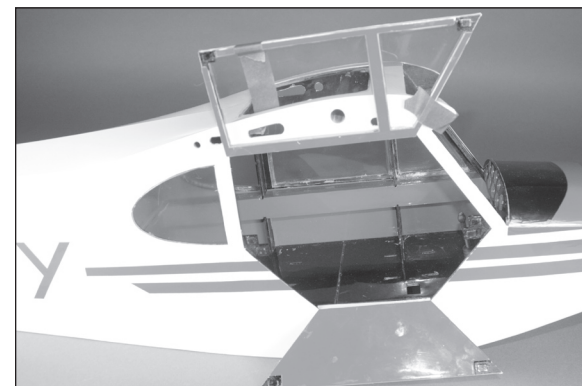
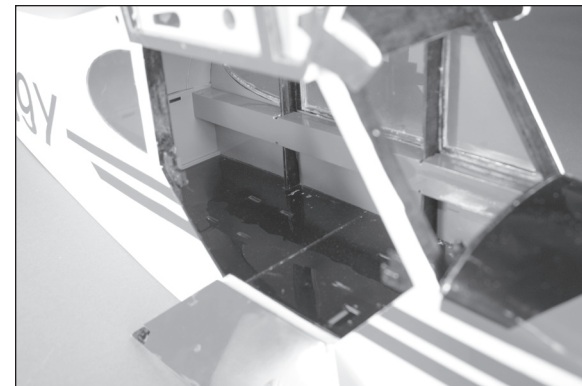
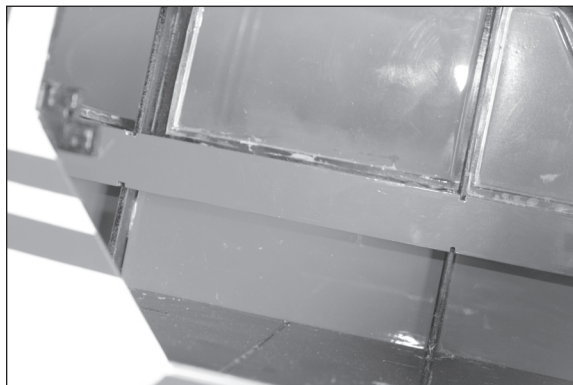



- 2. When installing the upper rear pieces, note that the piece that fits in the center will slide into the groove on the side pieces. Make sure the position of the side pieces is such that the center piece can be installed.

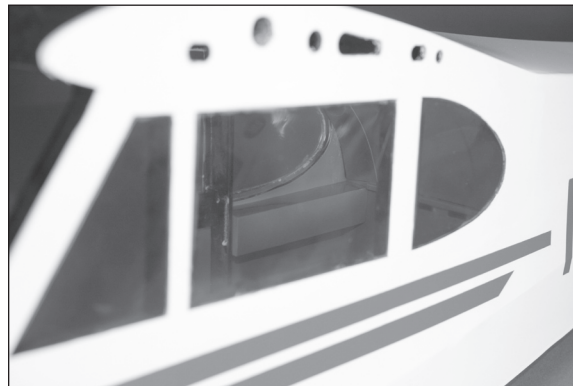
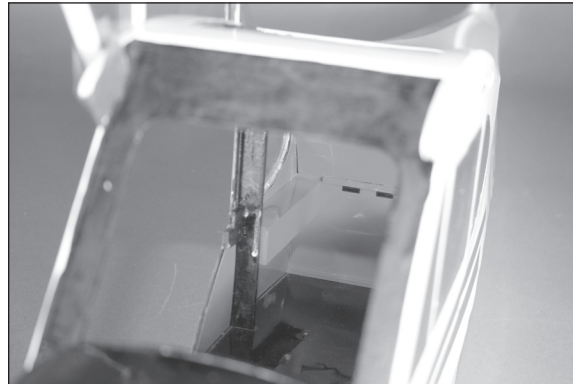
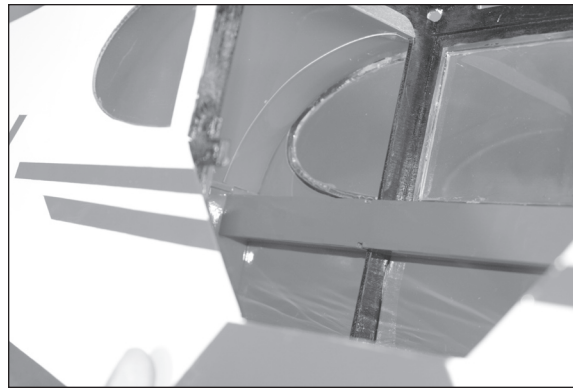
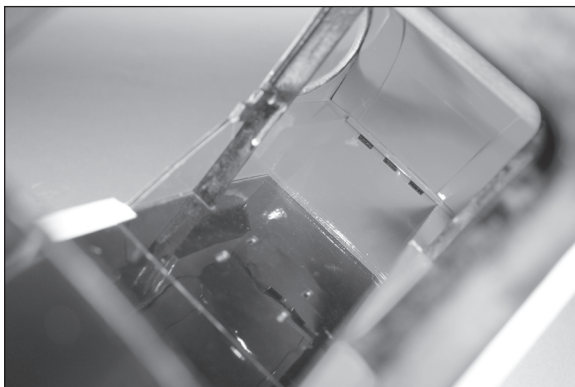
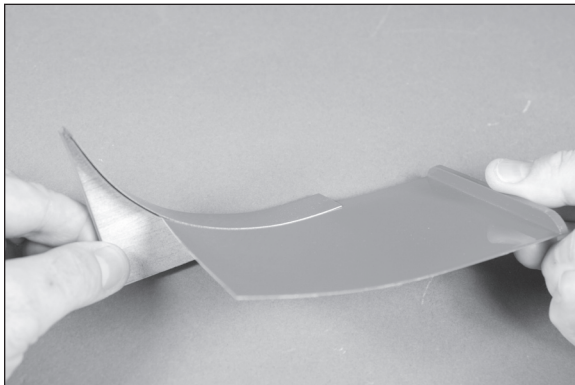

## Wing and Wing Strut Installation

### Required Parts

- Wing panel (right and left)
- Fuselage assembly
- Nylon wing bolt (2)
- Wing strut, front (right and left)
- Jury strut fitting (4)
- Wing strut, rear (right and left)
- Jury strut, front (2)
- Jury strut, rear (2)
- Jury strut brace (2)
- Aluminum wing tube
- 4-40 lock nut (12)
- #4 washer (16)
- 4-40 x 1/2-inch socket head cap screw (4)
- 4-40 x 3/8-inch socket head cap screw (12)

### Required Tools and Adhesives

- Hex wrench: 3/32-inch
- Nut driver: 1/4-inch

- 1. Slide the aluminum wing tube into the socket in the wing panel. The tube socket has a cap on it, so do not force the tube in any farther than it will easily slide.

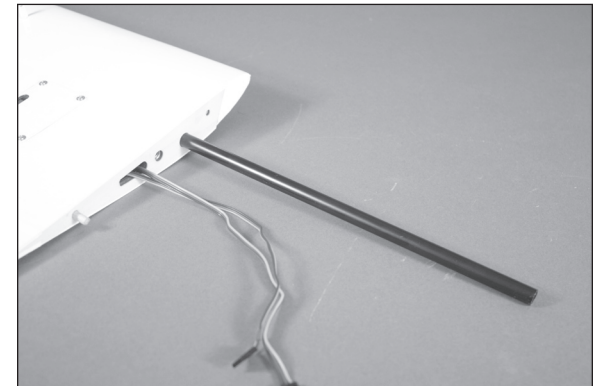

- 2. Install the threaded jury strut fitting in the wing so the threads are flush with the wing surface.

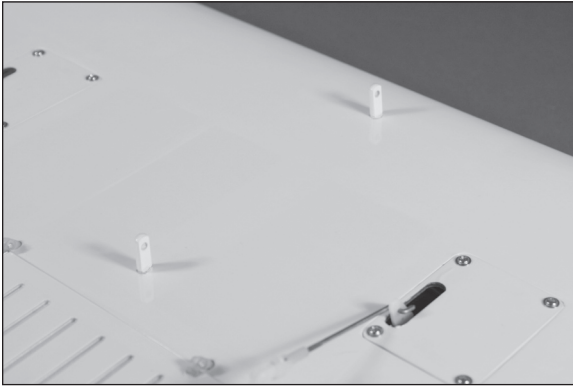

**Important:** When threading the jury strut fittings in the wing, make sure not to thread them in too far as they can protrude through the top of the wing.

**Important:** The jury strut fittings are threaded so they can be adjusted once the jury struts and wing struts are installed. The correct height of the fittings will allow the wing struts to be straight between the wing and fuselage. This alignment is described in step 7.

- 3. Slide the aluminum wing tube into the fuselage. Guide the flap and aileron extensions into the fuselage. The wing panel will fit tight against the fuselage as shown.

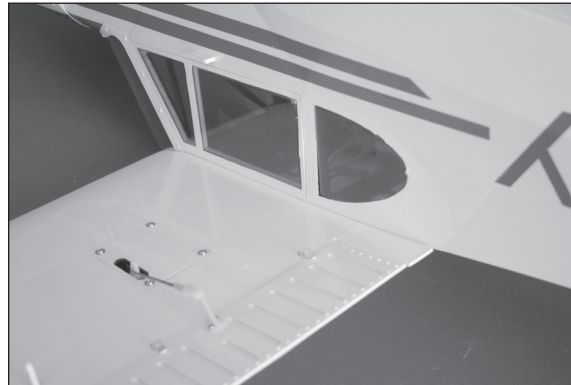

- 4. Secure the wing to the fuselage using a nylon wing bolt.



- 5. Temporarily attach the front and rear wing struts to the wing and wing strut tab. The airfoil of the struts will match the airfoil of the wing and the fitting on the wing strut will face toward the wing as shown in step 7. The longer strut is placed closer to the trailing edge and the shorter strut toward the leading edge. Use 4-40 x 3/8-inch socket head cap screws and #4 washers to attach the strut. Two 4-40 lock nuts will need to be used at the strut fitting. Use a 3/32-inch hex wrench and 1/4-inch nut driver to tighten the hardware. Leave the hardware slightly loose so the strut position can be adjusted when installing the jury struts.

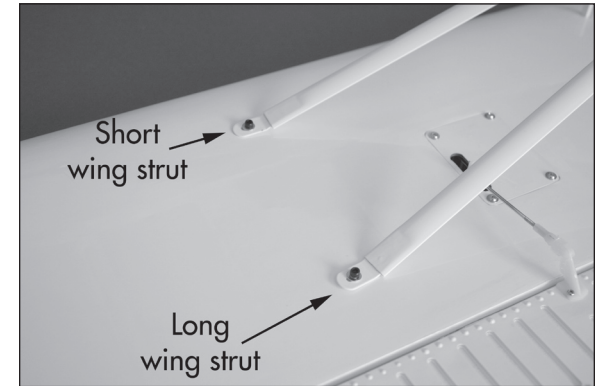

- 6. Use two 4-40 x 1/2-inch socket head screws, two 4-40 lock nuts and two #4 washers to attach the jury struts to the strut fittings on the wing. The longer jury strut is closer to the flap while the shorter jury strut is toward the leading edge of the wing. Leave the hardware slightly loose so the position of the jury struts can be adjusted.



- 7. Check to make sure the hole in the jury strut aligns with the hole in the fitting on the wing strut. Thread the jury strut fitting in or out as necessary so the hole aligns with the hole in the fitting on the wing strut. Check both the front and rear jury strut fittings.



- 8. The jury struts will attach to the fittings on the wing strut closest to the fuselage. Place a #4 washer on a 4-40 x 3/8-inch socket head cap screw, then slide the screw through the jury strut and the jury strut fitting. The jury strut brace is placed on the side of the fitting closest to the wing tip. A 4-40 lock nut is then threaded onto the screw.



- 9. Use a 3/32-inch hex wrench and 1/4-inch nut driver to tighten all the hardware to secure the wing struts to the wing and fuselage.



When removing the wing, only remove the hardware attaching the wing struts to the wing strut tab at the fuselage.

- 10. Repeat steps 2 and 9 to install the remaining wing strut and jury strut assemblies.

## Lighting Kit Installation (Optional)

### Required Parts

Wing panel (right and left)  
Landing light cover Navigation light cover (2)

### Optional Parts

36-inch lighting extension (3)  
Lighting Y-harness Clear LED light (2)  
Red LED light (L) Green LED light (R)

### Required Tools and Adhesives

Soldering iron Heat shrink  
Canopy glue

If you are not installing the optional lighting kit, skip this section of the manual.

- 1. Check the fit of the light in the tube in the wing for the landing light. Remove the light once the fit has been checked.

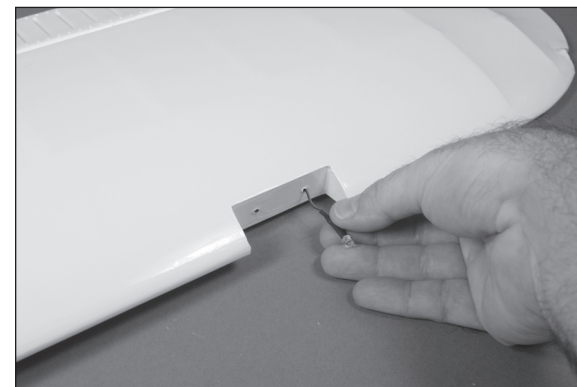

- 2. Use side cutters to remove the plug from the clear light. Remove the end of the 36-inch (915mm) lighting extension. Cut the length of the lead so when the light is installed, the lead protrudes approximately 1½-inches (38mm) from the wing root. Make sure the end that remains is the end that plugs into the lighting controller. Slide the extension through the tube into the wing root and out at the leading edge.

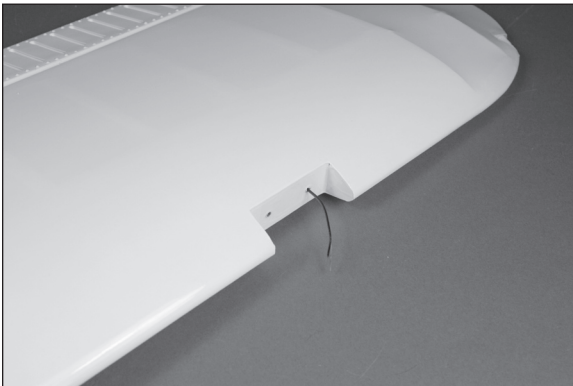
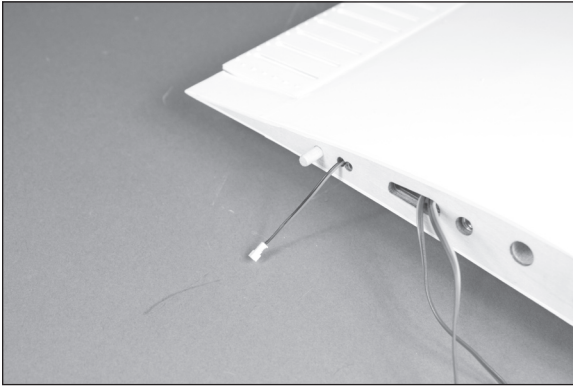

- 3. Carefully solder the extension to the light. Use care not to melt the wiring by leaving the soldering iron in position too long. Make sure to stagger the solder joints so the wires will fit into the tube in the wing. Use heat shrink to cover the solder joints to prevent shorting the wires.

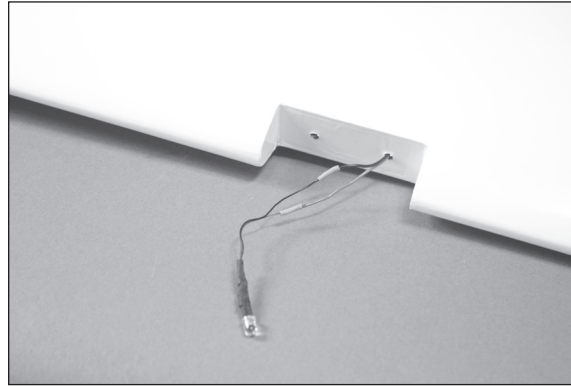

- 4. Repeat steps 1 through 3 to prepare the second landing light. Press the lights into position in the wing. It may be necessary to use a very small amount of silicone adhesive to keep the lights in position.

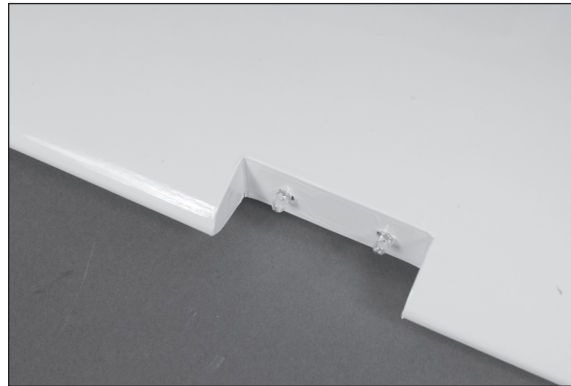

- 5. Use canopy glue to glue the landing light cover to the wing. Use low-tack tape to hold the cover in position until the glue fully cures.

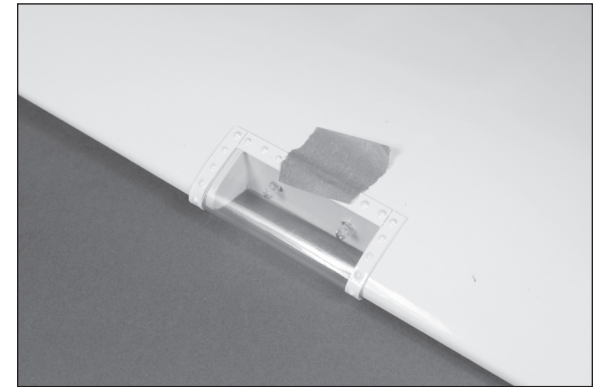

- 6. Connect the Y-harness for the landing lights outside the wing as shown.

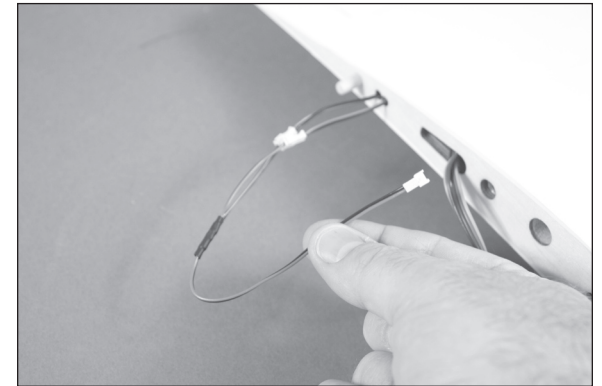

- ○ 7. Repeat steps 1 through 3 to prepare and install the navigation light. When installing the navigation lights, the red will be on the left, and the green will be on the right. Leave the light extended out so it is visible in the navigation light cover when the cover is installed.

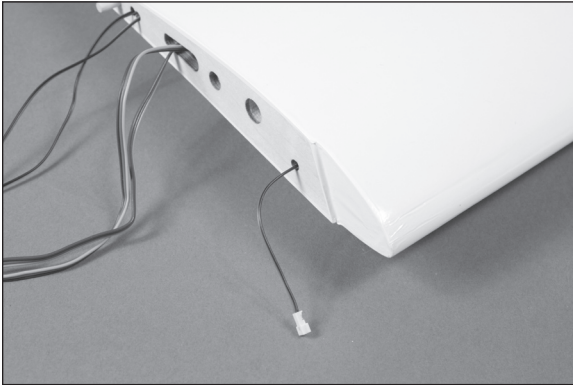

- ○ 8. Install the navigation light cover using canopy glue. The fit should be tight, so tape will not be needed to hold the cover in position.



- ○ 9. Use the template on page 45 to make the cover for the navigation light lens using adhesive-backed Ultracote trim sheet.

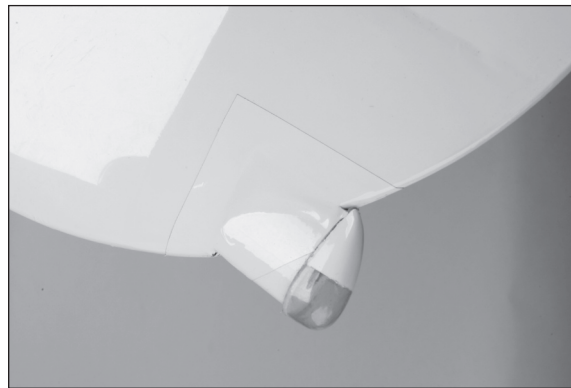

- 10. Repeat steps 1 through 3, and 7 through 9 to install the remaining navigation light.

## Accessory Installation

### Required Parts

Wing panel (right and left)  
Landing light cover Navigation light cover (2)

### Required Tools and Adhesives

Canopy glue

- 1. Use canopy glue to glue the landing light cover to the wing. Use low-tack tape to hold the cover in position until the glue fully cures.

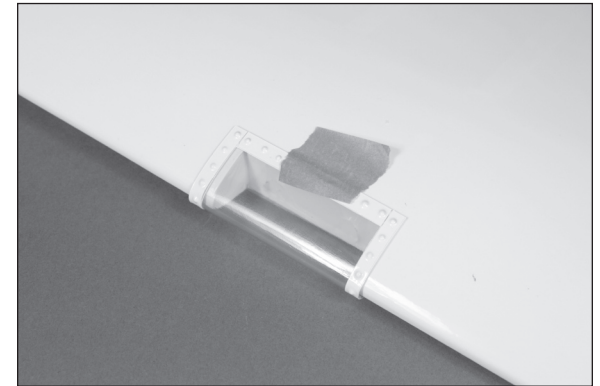

- ○ 2. Install the navigation light cover using canopy glue. The fit should be tight, so tape will not be needed to hold the cover in position.



- 3. Use the template on page 45 to make the cover for the navigation light lens using adhesive backed Ultracote trim sheet.

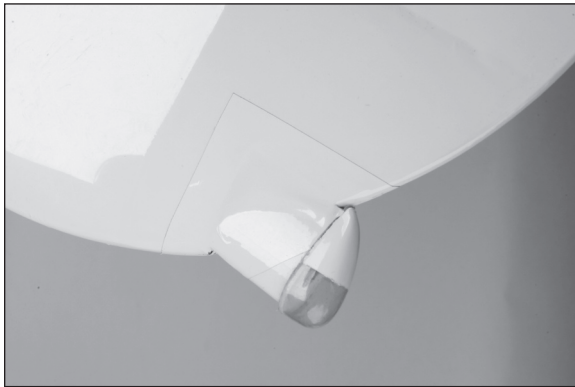

- 4. Repeat steps 2 and 3 to install the remaining navigation light.

## Center of Gravity

### Required Parts

Assembled airframe

### Required Tools and Adhesives

Felt-tipped pen      Ruler

Phillips screwdriver: #2

Balancing stand (optional)

An important part of preparing the aircraft for flight is properly balancing the model.



**CAUTION:** Do not inadvertently skip this step or property damage and injury could occur.

- 1. Assemble your model in preparation for flight, making sure the wing is on securely and the motor battery is installed as instructed in this manual.
- 2. The recommended Center of Gravity (CG) location for your model is 2.75 to 3.00 inches (70.0 to 76.0mm) back from the leading edge of the wing as shown with the battery pack installed. Mark the location of the CG on the top of the wing with a felt-tipped pen.



- 3. When balancing your model, support the plane upright at the marks made on the bottom of the wing with your fingers or a commercially available balancing stand. This is the correct balance point for your model. Make sure your model is assembled and ready for flight before balancing.

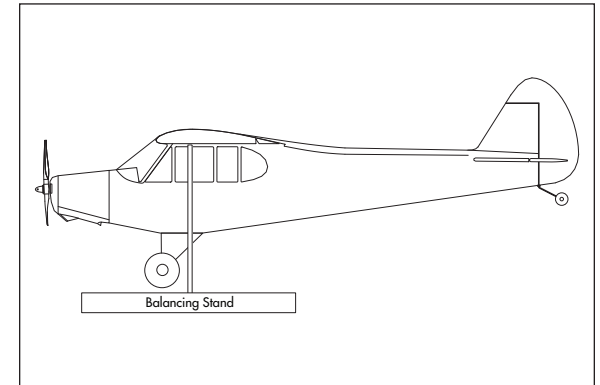

Adjust the motor battery as necessary so the model is level or slightly nose down. This is the correct balance point for your model. You should find the CG to be very close with the battery installed as shown in this manual. Mark the location of the battery on the battery tray using a felt-tipped pen so it can be returned to this position if it is removed from your model.

After the first flights, the CG position can be adjusted for your personal preference.

## Control Throws

- 1. Turn on the transmitter and receiver of your model. Check the movement of the rudder using the transmitter. When the stick is moved right, the rudder should also move right. Reverse the direction of the servo at the transmitter if necessary.
- 2. Check the movement of the elevator with the radio system. Moving the elevator stick toward the bottom of the transmitter should make the airplane elevator move up.
- 3. Check the movement of the ailerons with the radio system. Moving the aileron stick right should make the right aileron move up and the left aileron move down.
- 4. Use a ruler to adjust the throw of the elevator, ailerons and rudder. Adjust the position of the pushrod at the control horn to achieve the following measurements when moving the sticks to their endpoints.

### *E-tips*

The Super Cub benefits greatly from having aileron differential. The suggested DX8 transmitter has a provision for this that will allow you to set this up without adjusting your ailerons travel volumes. The differential on the DX8 should be set at 80%. This setting should allow the travel measurements to match these below. If not using a DX8, you can also set the travel adjustment to match the suggested throws.

#### Aileron

High Rate		
Up:	1-inch	25mm
Down:	1/4-inch	6mm
Low Rate		
Up:	11/16-inch	18mm
Down:	5/32-inch	4mm

#### Elevator

High Rate			
Up:	1 <sup>1</sup> / <sub>8</sub> -inch	28mm	15% Expo
Down:	1 <sup>1</sup> / <sub>8</sub> -inch	28mm	15% Expo
Low Rate			
Up:	3/4-inch	19mm	
Down:	3/4-inch	19mm	

#### Rudder

High Rate		
Right:	1 <sup>1</sup> / <sub>2</sub> -inch	38mm
Left:	1 <sup>1</sup> / <sub>2</sub> -inch	38mm
Low Rate		
Right:	1-inch	25mm
Left:	1-inch	25mm

#### Flap

Mid	3/4-inch	19mm
Full	1 <sup>1</sup> / <sub>4</sub> -inch	32mm

#### Elevator-to-Flap mixing

Mid flap: 5/32-inch (4mm) down elevator  
Full flap: 9/32-inch (7mm) down elevator

### *E-tips*

Measurements are taken at the inner or widest point on the control surface.

These are general guidelines measured from our own flight tests. You can experiment with higher rates to match your preferred style of flying.

### *E-tips*

Travel Adjust and Sub-Trims are not listed and should be adjusted according to each individual model and preference.

### *E-tips*

We highly recommend re-binding the radio system once all the control throws are set. This will keep the servos from moving to their endpoints until the transmitter and receiver connect.

## Preflight

### Check Your Radio

Before going to the field, be sure your batteries are fully charged per the instructions included with your radio. Charge the transmitter and motor battery for your airplane. Use the recommended charger supplied with your particular radio system, following the instructions provided with the radio. In most cases, the radio should be charged the night before going out flying.

Before each flying session, be sure to range check your radio. See your radio manual for the recommended range and instructions for your radio system. Each radio manufacturer specifies different procedures for their radio systems. Next, run the motor. With the model securely anchored, check the range again. The range test should not be significantly affected. If it is, don't attempt to fly! Have your radio equipment checked out by the manufacturer.

Double-check that all controls (aileron, elevator, rudder and throttle) move in the correct direction.

Check the radio installation and make sure all the control surfaces are moving correctly (i.e., the correct direction and with the recommended throws).

Check all the control horns, servo horns, and clevises to make sure they are secure and in good condition.



## Range Test Your Radio

Before each flying session, and especially with a new model, it is important to perform a range check. It is helpful to have another person available to assist during the range check. If you are using a Spektrum transmitter, please refer to your transmitter's manual for detailed instructions on the range check process.

- 1. With the model resting on the ground, stand 30 paces (approximately 90 feet) away from the model.
- 2. Face the model with the transmitter in your normal flying position. Be sure the throttle is in the full down position and plug the flight battery into the speed control.
- 3. As you move the controls, watch to be sure the airplane's motor and controls operate smoothly. You should have total control of the model at 30 paces (90 feet).
- 4. If control issues exist, call the appropriate Horizon Product Support office (see addresses listed in the Warranty Services section of this manual) or go to [horizonhobby.com](http://horizonhobby.com) to find a local Spektrum distributor in your country for service if using a Spektrum radio system.

## Flying Your Model

Okay, it's time for the moment of truth. Now that you have your Super Cub at the field and put together, take the opportunity to check over everything one more time to ensure that all is in order. Verify control direction, battery level, CG and range check your model. After everything checks out, the only thing left to do is violate some air molecules.

Set your throttle trim to a low idle; this will be your flight idle. Taxi out to the runway and line up with the centerline. Smoothly advance the throttle and maintain directional control with the rudder. The Super Cub is a very light airplane and has a very large wing, so it doesn't take much airspeed to get airborne. If you hold a little up elevator, the airplane will be off in about 15 feet. If you apply a little down pressure to raise the tail, you'll have a longer takeoff run. Once you are airborne, establish a gentle climb angle and make a climbing turn to parallel yourself with the runway.

Once at altitude, you'll find yourself cruising around at half throttle. Trim the airplane out and get the feel for how it flies. Cubs are inherently very gentle, so you'll have no issues with maintaining control or getting behind the airplane. After you have the feel for it, try your hand at a few basic maneuvers—loops, rolls, wingovers, spins, etc. The airplane will perform these with great ease. Many full scale Cubs fly these barnstorming-type maneuvers, so coupled with the detail of this Platinum Series design, you'll have a hard time distinguishing your airplane from the real one!

Unfortunately, all good things must come to an end and your flight battery is the malevolent dictator of this directive. Before you try and set up for a landing, pull the power back and try some slow flight. Extend the flaps and get used to how the airplane handles with flaps extended. They have quite a bit of area, so they will induce a lot of drag when you have them fully extended. It's best in a landing configuration to not try and drag the airplane in with flaps; you need to aim it at the ground and fly it in.

Set up on a downwind leg and reduce power. When you are abeam your touchdown point, add the first notch of flaps. Continue your descent into your base leg and onto final. Gauge your descent rate and let that be your judge whether or not to fully extend your flaps. When you are over the threshold, begin to reduce power to idle. When you get close to the ground, round out your descent and flare. You should touch down gently. Once back on the ground, maintain directional control with the rudder.

That's it! You've just flown your Platinum Series Super Cub from E-flite. We wish you many more successful and enjoyable flights with it in the future!

## Daily Flight Checks

- 1. Check the battery voltage of the transmitter battery. Do not fly below the manufacturer's recommended voltage. To do so may cause your aircraft to crash.

### ***E-tips***

When you check these batteries, ensure you have the polarities correct on your expanded scale voltmeter.

- 2. Check all hardware (linkages, screws, nuts, and bolts) prior to each day's flight. Be sure that binding does not occur and that all parts are properly secured.
- 3. Ensure all surfaces are moving in the proper manner.
- 4. Perform a ground range check before each day's flying session.
- 5. Prior to starting your aircraft, turn off your transmitter, then turn it back on. Do this each time you start your aircraft. If any critical switches are on without your knowledge, the transmitter alarm will sound a warning.
- 6. Check that all trim levers are in the proper location.
- 7. All servo pigtails and switch harness plugs should be secured in the receiver. Make sure the switch harness moves freely in both directions.

## Limited Warranty

### WHAT THIS WARRANTY COVERS

Horizon Hobby, Inc. ("Horizon") warrants to the original purchaser that the product purchased (the "Product") will be free from defects in materials and workmanship at the date of purchase.

### WHAT IS NOT COVERED

This warranty is not transferable and does not cover (i) cosmetic damage, (ii) damage due to acts of God, accident, misuse, abuse, negligence, commercial use, or due to improper use, installation, operation or maintenance, (iii) modification of or to any part of the Product, (iv) attempted service by anyone other than a Horizon Hobby authorized service center, or (v) Products not purchased from an authorized Horizon dealer.

OTHER THAN THE EXPRESS WARRANTY ABOVE, HORIZON MAKES NO OTHER WARRANTY OR REPRESENTATION, AND HEREBY DISCLAIMS ANY AND ALL IMPLIED WARRANTIES, INCLUDING, WITHOUT LIMITATION, THE IMPLIED WARRANTIES OF NON-INFRINGEMENT, MERCHANTABILITY AND FITNESS FOR A PARTICULAR PURPOSE. THE PURCHASER ACKNOWLEDGES THAT THEY ALONE HAVE DETERMINED THAT THE PRODUCT WILL SUITABLY MEET THE REQUIREMENTS OF THE PURCHASER'S INTENDED USE.

### PURCHASER'S REMEDY

Horizon's sole obligation and purchaser's sole and exclusive remedy shall be that Horizon will, at its option, either (i) service, or (ii) replace, any Product determined by Horizon to be defective. Horizon reserves the right to inspect any and all Product(s) involved in a warranty claim. Service or replacement decisions are at the sole discretion of Horizon. Proof of purchase is required for all warranty claims. SERVICE OR REPLACEMENT AS PROVIDED UNDER THIS WARRANTY IS THE PURCHASER'S SOLE AND EXCLUSIVE REMEDY.

## LIMITATION OF LIABILITY

HORIZON SHALL NOT BE LIABLE FOR SPECIAL, INDIRECT, INCIDENTAL OR CONSEQUENTIAL DAMAGES, LOSS OF PROFITS OR PRODUCTION OR COMMERCIAL LOSS IN ANY WAY, REGARDLESS OF WHETHER SUCH CLAIM IS BASED IN CONTRACT, WARRANTY, TORT, NEGLIGENCE, STRICT LIABILITY OR ANY OTHER THEORY OF LIABILITY, EVEN IF HORIZON HAS BEEN ADVISED OF THE POSSIBILITY OF SUCH DAMAGES. Further, in no event shall the liability of Horizon exceed the individual price of the Product on which liability is asserted. As Horizon has no control over use, setup, final assembly, modification or misuse, no liability shall be assumed nor accepted for any resulting damage or injury. By the act of use, setup or assembly, the user accepts all resulting liability. If you as the purchaser or user are not prepared to accept the liability associated with the use of the Product, purchaser is advised to return the Product immediately in new and unused condition to the place of purchase.

## LAW

These terms are governed by Illinois law (without regard to conflict of law principals). This warranty gives you specific legal rights, and you may also have other rights which vary from state to state. Horizon reserves the right to change or modify this warranty at any time without notice.

## Warranty Services

### QUESTIONS, ASSISTANCE, AND SERVICES

Your local hobby store and/or place of purchase cannot provide warranty support or service. Once assembly, setup or use of the Product has been started, you must contact Horizon directly. This will enable Horizon to better answer your questions and service you in the event that you may need any assistance. For questions or assistance, please direct your email to [productsupport@horizonhobby.com](mailto:productsupport@horizonhobby.com), or call 877.504.0233 toll free to speak to a Product Support representative. You may also find information on our website at [www.horizonhobby.com](http://www.horizonhobby.com).

### INSPECTION OR SERVICES

If this Product needs to be inspected or serviced, please use the Horizon Online Service Request submission process found on our website or call Horizon to obtain a Return Merchandise Authorization (RMA) number. Pack the Product securely using a shipping carton. Please note that original boxes may be included, but are not designed to withstand the rigors of shipping without additional protection. Ship via a carrier that provides tracking and insurance for lost or damaged parcels, as Horizon is not responsible for merchandise until it arrives and is accepted at our facility. An Online Service Request is available at <http://www.horizonhobby.com> under the Support tab. If you do not have internet access, please contact Horizon Product Support to obtain a RMA number along with instructions for submitting your product for service. When calling Horizon, you will be asked to provide your complete name, street address, email address and phone number where you can be reached during business hours. When sending product into Horizon, please include your RMA number, a list of the included items, and a brief summary of the problem. A copy of your original sales receipt must be included for warranty consideration. Be sure your name, address, and RMA number are clearly written on the outside of the shipping carton.

**Notice: Do not ship LiPo batteries to Horizon. If you have any issue with a LiPo battery, please contact the appropriate Horizon Product Support office.**

*E-flite Super Cub 25e ARF Assembly Manual*

### WARRANTY REQUIREMENTS

**For Warranty consideration, you must include your original sales receipt verifying the proof-of-purchase date.** Provided warranty conditions have been met, your Product will be serviced or replaced free of charge. Service or replacement decisions are at the sole discretion of Horizon.

### NON-WARRANTY SERVICE

**Should your service not be covered by warranty service will be completed and payment will be required without notification or estimate of the expense unless the expense exceeds 50% of the retail purchase cost.** By submitting the item for service you are agreeing to payment of the service without notification. Service estimates are available upon request. You must include this request with your item submitted for service. Non-warranty service estimates will be billed a minimum of ½ hour of labor. In addition you will be billed for return freight. Horizon accepts money orders and cashiers checks, as well as Visa, MasterCard, American Express, and Discover cards. By submitting any item to Horizon for service, you are agreeing to Horizon's Terms and Conditions found on our website <http://www.horizonhobby.com/Service/Request/>.

### UNITED STATES

*(Electronics and engines)*

Horizon Service Center  
4105 Fieldstone Rd  
Champaign, Illinois  
61822 USA  
[productsupport@horizonhobby.com](mailto:productsupport@horizonhobby.com)  
877-504-0233  
Online Repair Request visit:  
[www.horizonhobby.com/repairs](http://www.horizonhobby.com/repairs)

*(All other products)*

Horizon Product Support  
4105 Fieldstone Rd  
Champaign, Illinois  
61822 USA  
[productsupport@horizonhobby.com](mailto:productsupport@horizonhobby.com)  
877-504-0233

### UNITED KINGDOM

Horizon Hobby Limited  
Units 1-4 Ployters Rd  
Staple Tye  
Harlow, Essex  
CM18 7NS  
United Kingdom  
[sales@horizonhobby.co.uk](mailto:sales@horizonhobby.co.uk)  
+44 (0) 1279 641 097

### GERMANY

Horizon Technischer Service  
Hamburger Str. 10  
25335 Elmshorn  
Germany  
[service@horizonhobby.de](mailto:service@horizonhobby.de)  
+49 4121 46199 66

### FRANCE

Horizon Hobby SAS  
14 Rue Gustave Eiffel  
Zone d'Activité du Réveil Matin  
91230 Montgeron  
+33 (0) 1 60 47 44 70

## Compliance Information for the European Union



### INSTRUCTIONS FOR DISPOSAL OF WEEE BY USERS IN THE EUROPEAN UNION

This product must not be disposed of with other waste. Instead, it is the user's responsibility to dispose of their waste equipment by handing it over to a designated collection point for the recycling of waste electrical and electronic equipment. The separate collection and recycling of your waste equipment at the time of disposal will help to conserve natural resources and ensure that it is recycled in a manner that protects human health and the environment. For more information about where you can drop off your waste equipment for recycling, please contact your local city office, your household waste disposal service or where you purchased the product.

## Academy of Model Aeronautics National Model Aircraft Safety Code

Effective January 1, 2011

### A. GENERAL

A model aircraft is a non-human-carrying aircraft capable of sustained flight in the atmosphere. It may not exceed limitations of this code and is intended exclusively for sport, recreation and/or competition. All model flights must be conducted in accordance with this safety code and any additional rules specific to the flying site.

1. Model aircraft will not be flown:
  - (a) In a careless or reckless manner.
  - (b) At a location where model aircraft activities are prohibited.
2. Model aircraft pilots will:
  - (a) Yield the right of way to all man carrying aircraft.
  - b) See and avoid all aircraft and a spotter must be used when appropriate. (AMA Document #540-D-See and Avoid Guidance.)
  - (c) Not fly higher than approximately 400 feet above ground level within three (3) miles of an airport, without notifying the airport operator.
  - (d) Not interfere with operations and traffic patterns at any airport, heliport or seaplane base except where there is a mixed use agreement.
  - (e) Not exceed a takeoff weight, including fuel, of 55 pounds unless in compliance with the AMA Large Model Aircraft program. (AMA Document 520-A)
  - (f) Ensure the aircraft is identified with the name and address or AMA number of the owner on the inside or affixed to the outside of the model aircraft. (This does not apply to model aircraft flown indoors).
  - (g) Not operate aircraft with metal-blade propellers or with gaseous boosts except for helicopters operated under the provisions of AMA Document #555.
  - (h) Not operate model aircraft while under the influence of alcohol or while using any drug which could adversely affect the pilot's ability to safely control the model.

(i) Not operate model aircraft carrying pyrotechnic devices which explode or burn, or any device which propels a projectile or drops any object that creates a hazard to persons or property.

Exceptions:

- Free Flight fuses or devices that burn producing smoke and are securely attached to the model aircraft during flight.
- Rocket motors (using solid propellant) up to a G-series size may be used provided they remain attached to the model during flight. Model rockets may be flown in accordance with the National Model Rocketry Safety Code but may not be launched from model aircraft.
- Officially designated AMA Air Show Teams (AST) are authorized to use devices and practices as defined within the Team AMA Program Document (AMA Document #718).
  - (j) Not operate a turbine-powered aircraft, unless in compliance with the AMA turbine regulations. (AMA Document #510-A).
- 3. Model aircraft will not be flown in AMA sanctioned events, air shows or model demonstrations unless:
  - (a) The aircraft, control system and pilot skills have successfully demonstrated all maneuvers intended or anticipated prior to the specific event.
  - (b) An inexperienced pilot is assisted by an experienced pilot.
- 4. When and where required by rule, helmets must be properly worn and fastened. They must be OSHA, DOT, ANSI, SNELL or NOCSAE approved or comply with comparable standards.

### B. RADIO CONTROL (RC)

1. All pilots shall avoid flying directly over unprotected people, vessels, vehicles or structures and shall avoid endangerment of life and property of others.
2. A successful radio equipment ground-range check in accordance with manufacturer's recommendations will be completed before the first flight of a new or repaired model aircraft.

3. At all flying sites a safety line(s) must be established in front of which all flying takes place (AMA Document #706-Recommended Field Layout):
  - (a) Only personnel associated with flying the model aircraft are allowed at or in front of the safety line.
  - (b) At air shows or demonstrations, a straight safety line must be established.
  - (c) An area away from the safety line must be maintained for spectators.
  - (d) Intentional flying behind the safety line is prohibited.
4. RC model aircraft must use the radio-control frequencies currently allowed by the Federal Communications Commission (FCC). Only individuals properly licensed by the FCC are authorized to operate equipment on Amateur Band frequencies.
5. RC model aircraft will not operate within three (3) miles of any pre-existing flying site without a frequency-management agreement (AMA Documents #922- Testing for RF Interference; #923- Frequency Management Agreement)
6. With the exception of events flown under official AMA Competition Regulations, excluding takeoff and landing, no powered model may be flown outdoors closer than 25 feet to any individual, except for the pilot and the pilot's helper(s) located at the flight line.
7. Under no circumstances may a pilot or other person touch a model aircraft in flight while it is still under power, except to divert it from striking an individual. This does not apply to model aircraft flown indoors.
8. RC night flying requires a lighting system providing the pilot with a clear view of the model's attitude and orientation at all times.
9. The pilot of a RC model aircraft shall:
  - (a) Maintain control during the entire flight, maintaining visual contact without enhancement other than by corrective lenses prescribed for the pilot.
  - (b) Fly using the assistance of a camera or First-Person View (FPV) only in accordance with the procedures outlined in AMA Document #550.

### **C. FREE FLIGHT**

1. Must be at least 100 feet downwind of spectators and automobile parking when the model aircraft is launched.
2. Launch area must be clear of all individuals except mechanics, officials, and other fliers.
3. An effective device will be used to extinguish any fuse on the model aircraft after the fuse has completed its function.

### **D. CONTROL LINE**

1. The complete control system (including the safety thong where applicable) must have an inspection and pull test prior to flying.
2. The pull test will be in accordance with the current Competition Regulations for the applicable model aircraft category.
3. Model aircraft not fitting a specific category shall use those pull-test requirements as indicated for Control Line Precision Aerobatics.
4. The flying area must be clear of all utility wires or poles and a model aircraft will not be flown closer than 50 feet to any above-ground electric utility lines.
5. The flying area must be clear of all nonessential participants and spectators before the engine is started.

### **NAVIGATION LIGHT TRIM TEMPLATE**

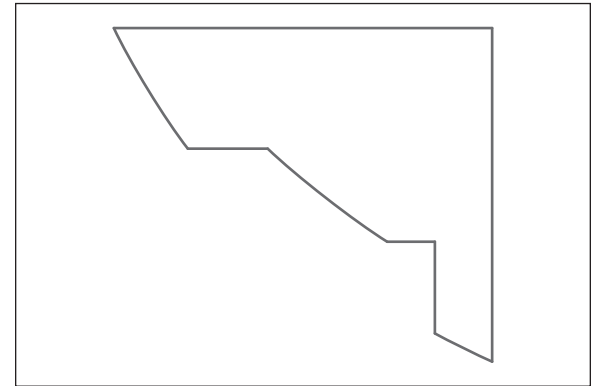



## ***Building and Flying Notes***

---

---

---

---

---

---

---

---

---

---

---

---

---

---

---

---

---

---

---

---

---

---

---

---

---



© 2011 Horizon Hobby, Inc.  
horizonhobby.com  
www.e-fliterc.com

*The Spektrum trademark is used with permission of Bachmann Industries, Inc.*

*E-flite, DSM, DSM2, DSMX, Celectra and the Horizon Hobby logo are trademarks or registered trademarks of Horizon Hobby, Inc.*

*All other trademarks, service marks and logos are the property of their respective owners.*