



Fly First Class™

RV-8

Assembly Manual



Specifications

Wingspan:	61 in (1549mm)
Length:	52 in (1321mm)
Wing Area:	732 sq in (sq dm)
Weight:	6.5–7 lb (2.9–3.2 kg)
Radio:	5-channel with 6–7 servos
Engine:46–.52 2-stroke, .72–.82 4-stroke, EFL Power 46 EP

RV-8 is a trademark of Van's Aircraft and is used with permission.

Table of Contents

Contents of Kit and Parts Layout.....	2
Included Hardware.....	3
Using the Manual.....	4
UltraCote Covering Colors	4
Before Starting Assembly	4
Radio Systems Requirements.....	4
Recommended Setup—2-Stroke Glow	4
Recommended Setup—4-Stroke Glow	4
Recommended Setup—Electric.....	4
Field Equipment Required.....	4
Optional Field Equipment.....	4
Tools and Supplies.....	4
Additional Required Adhesives	5
FS One	5
Important Information Regarding Warranty Information	5
Section 1: Landing Gear Installation	5
Section 2: Servo and Receiver Installation	9
Section 3: Rudder Cable Installation.....	11
Section 4: Elevator/Stabilizer Installation.....	14
Section 5: 2-Stroke Engine Installation.....	18
Section 6: 4-Stroke Engine Installation.....	20
Section 7: Fuel Tank Installation and Throttle Linkage Connection	22
Section 8: Electric Motor Installation.....	25
Section 9: Cowling and Spinner Installation	29
Section 10: Canopy and Pilot Installation	31
Section 11: Aileron and Flap Servo Installation	32
Section 12: Wing and Canopy Hatch installation	37
Section 13: Center of Gravity.....	39
Section 14: Control Throws	39
Section 15: Flight Preparations.....	40
Section 16: Maintaining Your Model.....	40
Section 17: Safety Do's and Don'ts for Pilots	41
Section 18: Daily Flight Checks.....	41
Section 19: Glossary of Terms.....	42
Section 20: Safety, Precautions and Warnings	42
Section 21: Warranty Information.....	43
Instructions for Disposal of WEEE by Users in the European Union	44
2009 Official Academy of Model Aeronautics Safety Code	45
Engine Mounting Template	47
Air Exit Template (EP).....	47

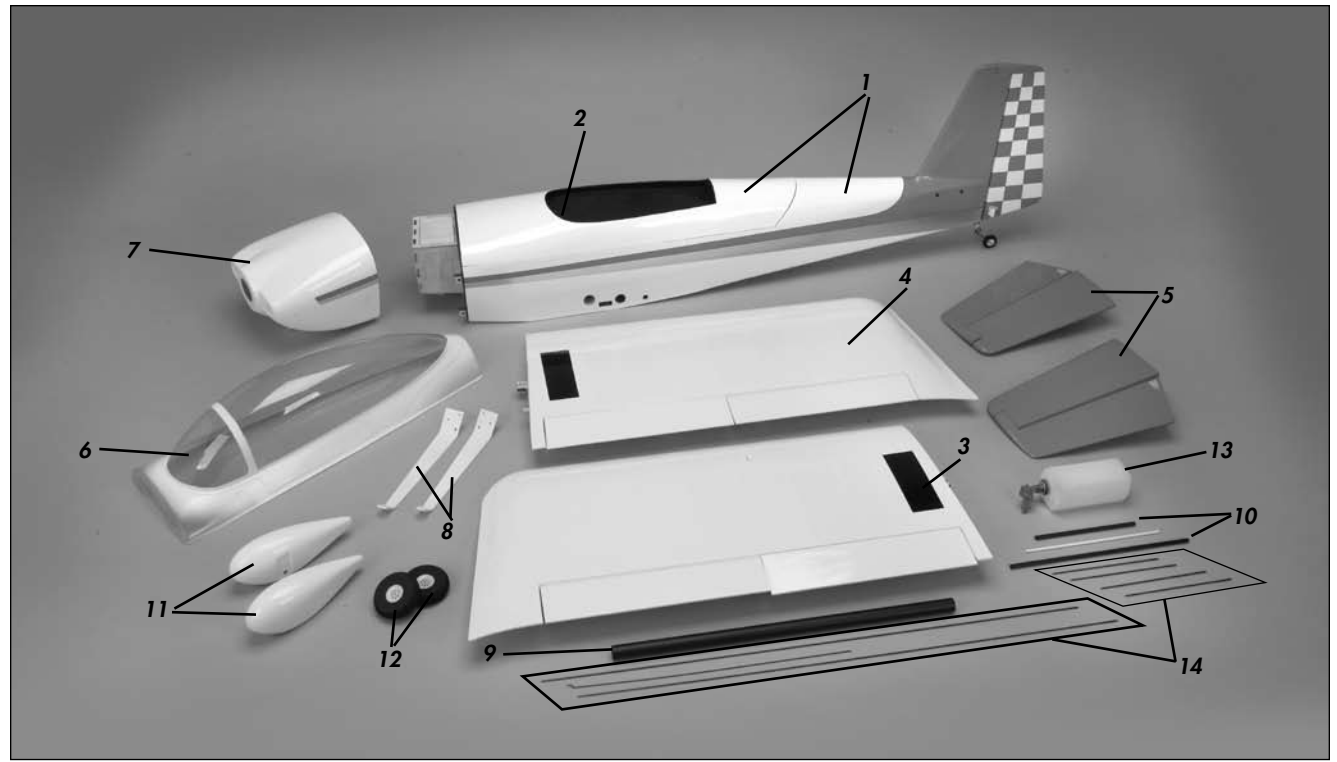

Contents of Kit and Parts Layout

Large Replacement Parts

1.	HAN4841	Fuselage with Hatch
2.	HAN4842	Fuselage Hatch
3.	HAN4843	Left Wing Panel
4.	HAN4844	Right Wing Panel
5.	HAN4845	Stabilizer (left and right)
6.	HAN4846	Canopy
7.	HAN4847	Cowling
8.	HAN4848	Aluminum Landing Gear Legs
9.	HAN4849	Aluminum Anodized Wing Tube
10.	HAN4850	Aluminum Anodized Stabilizer Tube Set
11.	HAN4851	Wheel Pants (left and right)
12.	HAN4852	2½-inch Foam Wheels
13.	HAN4855	Glow Fuel Tank, 8.8 oz (260cc)
14.	HAN4858	Pushrods

Small Replacement Parts (not shown)

HAN4853	Engine Mount with Hardware
HAN4854	45mm EP Motor Mount with Hardware
HAN4856	Nylon Pushrod Connectors
HAN4857	Pull-Pull Rudder Hardware
HAN4859	Servo Mounting Blocks
HAN4848A	Landing Gear Axles

Included Parts and Hardware

WING

Left wing with aileron and flap	1	
Right wing with aileron and flap	1	
Clevis	4	aileron & flaps
Pushrod keeper	4	aileron & flaps
2mm x 10mm self-tapping screw	16	ail & flap servo cover
19mm x 19mm x 10mm wood block	8	hard point for ail & flap servos
2mm x 180mm pushrod threaded one end	4	aileron/flap pushrods
3mm x 20mm socket head cap screw	2	wing mounting
3mm flat washer	2	wing mounting
20mm x 480mm aluminum wing tube	1	wing mounting
4mm x 270mm aluminum stab tube	1	stab mounting
4mm x 160mm aluminum stab tube	1	stab mounting

LANDING GEAR

Right side white aluminum landing gear	1	
Left side white aluminum landing gear	1	
2 1/2-inch (63mm) wheel	2	
Wheel pants, white	2	
3mm x 10mm screw	2	wheel pant to landing gear
3mm blind nut	2	wheel pant
4mm wheel collar with setscrew	4	wheels
5mm hex head machine screw and wheel axle	2	wheel axle
5mm hex nut	2	axle to the landing gear
3mm x 12mm socket head cap screw	6	landing gear to fuselage
3mm flat washer	6	landing gear to fuselage

FUSELAGE

Fuselage with canopy hatch	1	
Canopy	1	
Fuel tank, assembled	1	
3mm x 15mm socket head cap screw	6	cowl & canopy hatch
3mm flat washer	6	cowl & canopy hatch
4-40 x 1-inch socket head cap screw	4	engine to engine mount
4-40 lock nut	4	engine to engine mount
#4 flat washer	4	engine mount
Small nylon motor mount	2	2 & 4 stroke engine
EP 42mm aluminum standoff	4	electric motor
8-32 blind nut	4	engine mount to firewall
8-32 x 3/4-inch socket head cap screw	8	glow and EP mount
#8 flat washer	4	engine mount to firewall
Nylon throttle linkage housing	1	
Fuel tank support (wood)	1	
2mm x 400mm pushrod with z-bend	1	throttle linkage

RUDDER, AND ELEVATORS

Right stabilizer with elevator	1	
Left stabilizer with elevator	1	
Clevis	4	elevator & rudder (Installed)
Pushrod keeper	1	elevator
Pull-pull wire	1	rudder
Rigging couplers threaded	2	rudder control horn
Aluminum crimps with plastic end	6	rudder (2 extra)
Rigging couplers with z-bend	2	rudder servo arm
2mm x 740mm pushrod threaded one end	2	elevator pushrods
4mm wheel collar	2	elevator
3mm x 3mm setscrew	2	elevator

Using the Manual

This manual is divided into sections to help make assembly easier to understand, and to provide breaks between each major section. In addition, check boxes have been placed next to each step to keep track of each step completed. Steps with a single box (☐) are performed once, while steps with two boxes (☐☐) indicate that the step will require repeating, such as for a right or left wing panel, two servos, etc. Remember to take your time and follow the directions.

UltraCote® Covering Colors

• Black	HANU874
• White	HANU870
• Silver	HANU881
• True Red	HANU866

Before Starting Assembly

Before beginning the assembly of your model, remove each part from its bag for inspection. Closely inspect the fuselage, wing panels, rudder and stabilizer for damage. If you find any damaged or missing parts, contact the place of purchase.

If you find any wrinkles in the covering, use a heat gun or covering iron to remove them. Use caution while working around areas where the colors overlap to prevent separating the colors.



HAN100 – Heat Gun

HAN150 – Covering Glove



HAN101 – Sealing Iron

HAN141 – Sealing Iron Sock

Radio Systems Requirements

Spektrum Radio System (recommended)

- DX6i 6-channel radio or greater with receiver (SPM6600)
- JRPS821 DS821 Digital Sport Servo (7) (6 required for EP version)
- JSP98110 6-inch Servo Extension (2)
- JSP98020 Y-Harness (2) or JSP98110 6-inch Servo Extension (4) for receiver to flap and aileron servo extensions
- Receiver Battery, 2700mAh
- JR Switch, Chargeswitch (JRPA004)

Recommended Setup–2-Stroke Glow

- Evolution® .46NX with Muffler (EVOE0460)
- Evolution Propeller 11 x 5 (EVO11050) to 11 x 6 (EVO11060)
- 2 3/4-inch Spinner (DUB290)
- Hangar 9 Fuel Filler Dot (Optional) (HAN115)
- Exhaust Diverter (DUB697) (optional)
- Pilot (not included) (HAN9119 or HAN9120)

Recommended Setup–4-Stroke Glow

- Saito™ .82 AAC with Muffler (SAIE082A or SAIE082AGK)
- Evolution Propeller 13 x 8 (EVO13080) or 14 x 6 (EVO14060)
- 2 3/4-inch Spinner (DUB290)
- Hangar 9 Fuel Filler Dot (Optional) (HAN115)
- Exhaust Diverter (DUB697) (optional)
- Pilot (not included) (HAN9119 or HAN9120)

Recommended Setup–Electric

- E-flite® Power 46 BL Outrunner Motor (EFLM4046A)
- 60-Amp Pro Switch-Mode BEC Brushless ESC (EFLA1060)
- Thunder Power 4S 3850–4500mAh LiPo battery pack
- APC Propeller 13x6.5-inch (APC13065E) to 14x7 (APC14070E)
- 2 3/4-inch Spinner (DUB290)
- JSP98030 12-inch Servo Extension
- Pilot (not included) (HAN9119 or HAN9120)

The Spektrum trademark is used with permission of Bachmann Industries, Inc.

Field Equipment Required

- Fuel (15% recommended)
- Propeller
- Long Reach Glow Plug Wrench (HAN2510)
- Metered Glow Driver with Ni-Cd & Charger (HAN7101)
- 2-Cycle Sport Plug (EVOGP1)
- Manual Fuel Pump (HAN118)

Optional Field Equipment

- Selfstick Weights, 6 oz (HAN3626)
- PowerPro 12V Starter (HAN161)
- 12V 7Ah Sealed Battery (HAN102)
- Power Panel (HAN106)
- Blue Block After Run Oil (EVOX1000)
- Cleaner and towels

Tools and Supplies

Crimping tool	Drill
Epoxy brush	Felt-tipped pen
Hobby knife with #11 blade	Hobby scissors
Hook and loop strap	Hook and loop tape
Low-tack tape	Medium grit sandpaper
Mixing cup	Mixing stick
Paper towel	Pencil
Phillips screwdriver: #1, #2	Pin drill
Pliers	Razor saw
Rotary tool	Cutoff wheel
Rubbing alcohol	Ruler
Sanding bar	Scissors
Side cutters	String
Threadlock	Tie wrap
T-pin	Trim seal tool
Sanding drum	
Foam rubber, 1/4-inch (6mm)	
Nut driver or box wrench: 1/4-inch	
Box wrench to fit propeller nut	
Box end or open end wrench: 10mm (2)	
Hex wrench or ball driver: 1.5mm, 2.5mm, 3/32-inch, 9/64-inch	
Drill bit: 1/16-inch (1.5mm), 5/64-inch (2mm), 1/8-inch (3mm), 5/32-inch (4mm), 11/64-inch (4.5mm), 7/32-inch (5.5mm)	

Additional Required Adhesives

30-Minute Epoxy	(HAN8002)
Canopy Glue	(PAAPT56)
Medium CA	(PAAPT02)
Thin CA	(PAAPT08)

FS One

With FS One® (HANS2008) you get more than photorealistic fields, gorgeous skies and realistic-looking aircraft. You get incredibly advanced aerodynamic modeling that simulates every possible aspect of real-world flight.

The first Hangar Pack® (HANS4010) will add even more aircraft to FS One. This latest edition includes ten new planes and helis from your favorite brands, including Hangar 9, E-flite and Align. You'll be able to fly aircraft that are only available on FS One such as the T-REX, Blade CX2, Blade CP Pro, Hangar 9 P-51 and F-22 PTS. And as always, with the Hangar Pack, you still get all the same great features that you did with the original aircraft.



HANS2008



HANS4010

Important Information Regarding Warranty Information

Please read our Warranty and Liability Limitations section on Page 40 before building this product. If you as the purchaser or user are not prepared to accept the liability associated with the use of this Product, you are advised to return this Product immediately in new and unused condition to the place of purchase.

Section 1: Landing Gear Installation

Required Parts

Fuselage	Wheel axle (2)
Wheel pant (right and left)	Wheel axle nut (2)
Wheel collar, 4mm (4)	3mm x 3mm setscrew (4)
3mm washer (6)	3mm blind nut (2)
Main landing gear right and left	
3mm x 10mm Phillips head screw (2)	
3mm x 12mm socket head screw (6)	

Tools and Adhesives

Drill bit: 1/8-inch (3mm)	Drill
Trim seal tool	Threadlock
Phillips screwdriver: #2	
Box end or open end wrench: 10mm (2)	
Hobby knife with #11 blade	
Hex wrench or ball driver: 1.5mm, 2.5mm	

Step 1

Carefully remove the canopy hatch from the fuselage by lifting it up from the rear. It is secured by magnets at the rear and dowels at the front. Slide the canopy rearward and set aside.



Step 2

Use a hobby knife with a #11 blade to remove the covering on the bottom of the fuselage to expose the mounts for the main landing gear.

Hint: Use a trim seal tool to iron the covering around the edges of the openings.



Hint: Seal the plywood by applying thin CA to the exposed plywood after you have sealed the covering down.

Step 3

Locate three 3mm x 12mm socket head screws and three 3mm washers. Slide a washer onto each of the screws.



□□ Step 4

Apply a drop of threadlock on each of the screws before using them to secure the main landing gear to the fuselage. Use a 2.5mm hex wrench to tighten the screws that secure the landing gear to the fuselage.

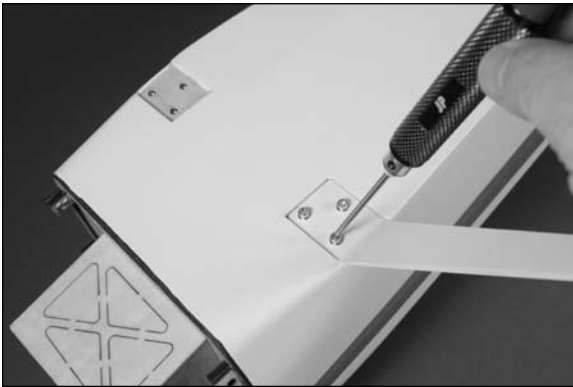
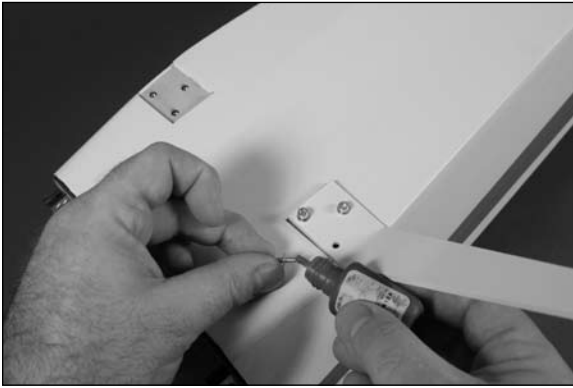

Note: There is a right and left landing gear. They cannot be interchanged or installed incorrectly.

□□ Step 5

Repeat Steps 3 and 4 to install the remaining landing gear.



□□ Step 6

Slide the wheel axle through the larger hole in the landing gear.



□□ Step 7

Slide the wheel pant onto the axle, making sure it is installed in the correct direction as there is a right and left wheel pant. Next, slide the wheel axle nut onto the axle. Temporarily tighten the nut to hold the wheel pant in position.



□□ Step 8

Position the fuselage on a stand so the wheel pant can be positioned parallel to the top of the fuselage line.

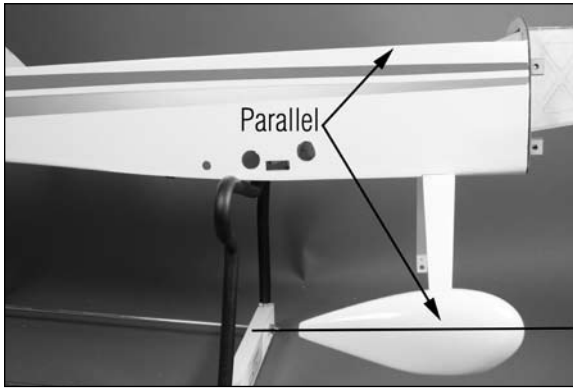

□□ Step 9

Use a felt-tipped pen to mark the location for the wheel pant mounting screw through the hole in the landing gear and on the wheel pant.

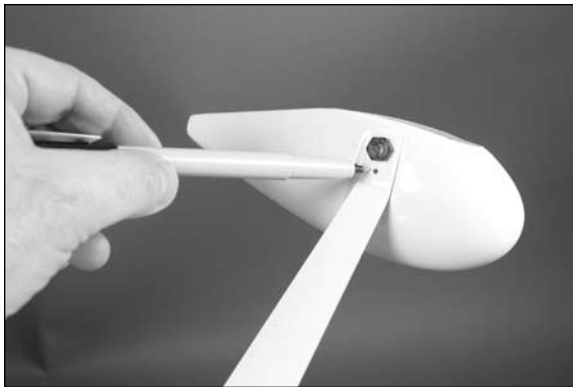

□□ Step 10

Remove the wheel pant from the landing gear. Use a drill and 1/8-inch (3mm) drill bit to drill a hole at the location marked in the previous step.



□□ Step 11

Use pliers to install the 3mm blind nut on the inside of the wheel pant in the hole just drilled. Apply a drop or two of thin CA to the blind nut to secure it in the wheel pant. Make sure not to get CA in the threads.



□□ Step 12

Place the wheel pant back on the landing gear as described in Step 6 and 7. Slide a 4mm wheel collar onto the wheel axle, then slide the wheel into position. Apply a drop of threadlock to the threads of the wheel axle and tighten the nut to secure the axle and wheel pant to the landing gear. Use either an adjustable wrench or 10mm open end wrench to tighten the nuts.





□□ Step 13

Apply a drop of threadlock to a 3mm x 3mm setscrew. Slide the wheel collar up against the nut and use the setscrew to secure the position of the wheel collar. Use a 1.5mm hex wrench to tighten the setscrew.

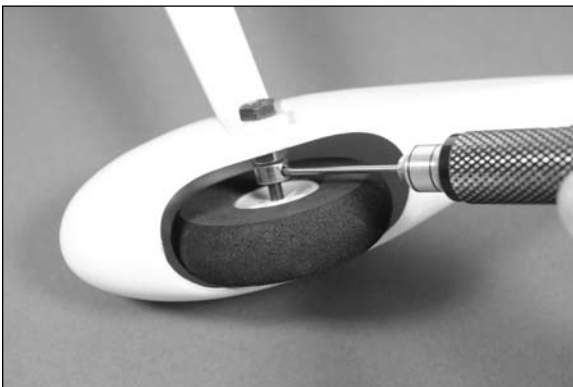

□□ Step 14

Slide another 4mm wheel collar on the axle. Use a 3mm x 3mm setscrew and 1.5mm hex wrench to secure the wheel collar after making sure the wheel can rotate freely on the axle.



□□ Step 15

Use a 3mm x 10mm Phillips head screw to secure the wheel pant. The screw threads into the blind nut installed inside the wheel pant. Tighten the screw using a #2 Phillips screwdriver.



□ Step 16

Repeat Steps 6 through 15 to install the remaining wheel and wheel pant.



Hint: Apply a small drop of lightweight oil to help the wheels to roll smoothly.

Section 2: Servo and Receiver Installation

Required Parts

Fuselage
Receiver battery (glow powered only)
Hook and loop strap (not included)
Y-harness (2) or 6-inch (152mm) servo extension (4)
12-inch (305mm) servo extension (EP version only)
Servo with hardware (2) (3 for glow-powered model)

Tools and Adhesives

Pencil
Drill bit: 1/16-inch (1.5mm)
Foam rubber, 1/4-inch (6mm)
Hobby knife with #11 blade
Thin CA
Drill
Phillips screwdriver: #1

Step 1

Prepare the rudder and elevator servos by installing the rubber grommets and brass eyelets as described in the servo or radio manual.

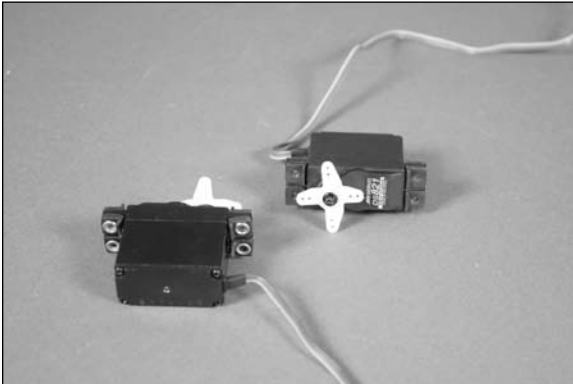

Step 2

Use a #1 Phillips screwdriver to thread a servo mounting screw into the holes in the radio tray for mounting the servos. Apply a drop or two of thin CA into each hole to harden the threads made by the screw. This will provide a much more secure mounting of the servos than if this step were skipped.

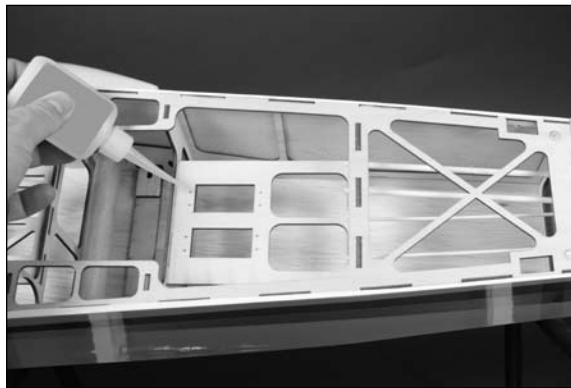

Step 3

Use a #1 Phillips screwdriver and the screws included with the servos to secure them in the servo tray.

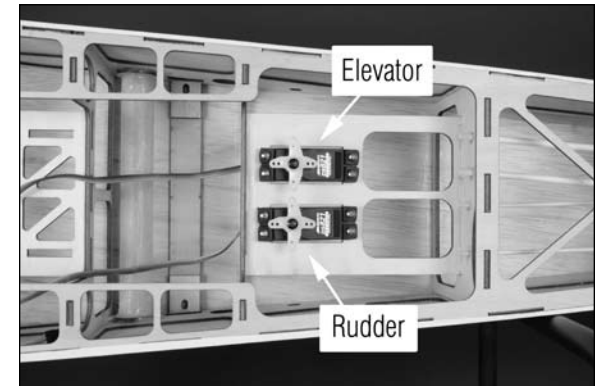

Step 4

Repeat Steps 1 through 3 to install the throttle servo in the forward servo tray.

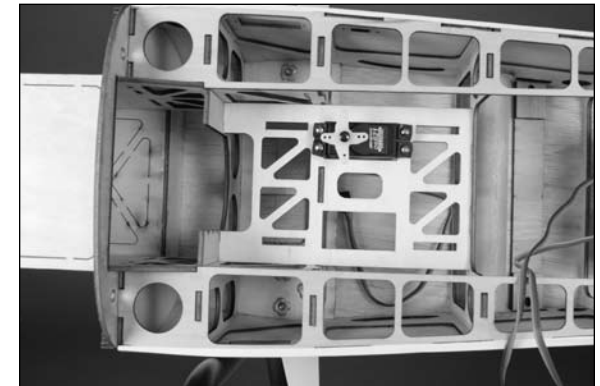

Note: If you are building the EP version it is not necessary to install the throttle servo.

□ Step 5

Use a hobby knife and #11 blade to remove the covering from the appropriate hole to mount the switch harness. Provisions have been made for either a larger or smaller switch in the side of the fuselage.

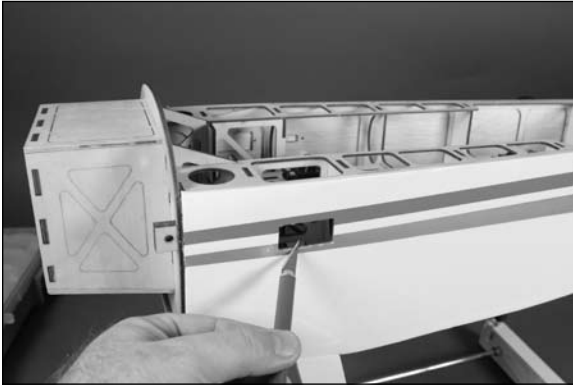

Note: The installation of the switch is only required for the installation of a glow motor. If you are building your model for electric, it is not necessary to mount the switch in the side of the fuselage.

□ Step 6

Mount the switch harness in the side of the fuselage using the hardware provided with the switch.



□ Step 7

Connect the receiver battery to the switch harness. Use a hook and loop strap (not included) to secure the receiver battery underneath the forward radio tray. Use 1/4-inch (6mm) foam to insulate the battery from the vibrations from the airframe.

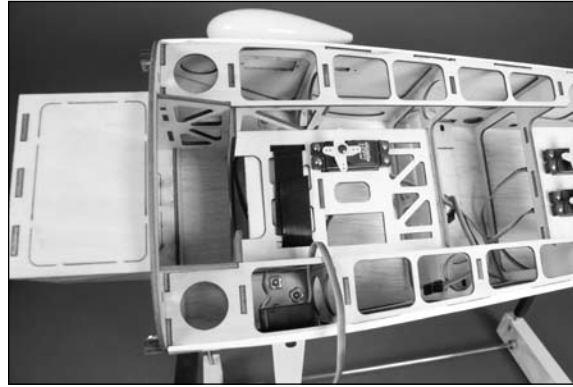

□ Step 8

Plug the leads from the switch harness, rudder, elevator and throttle servos into the appropriate ports of the receiver. Also plug extensions or a Y-harness in the receiver for both the aileron and flap servos.

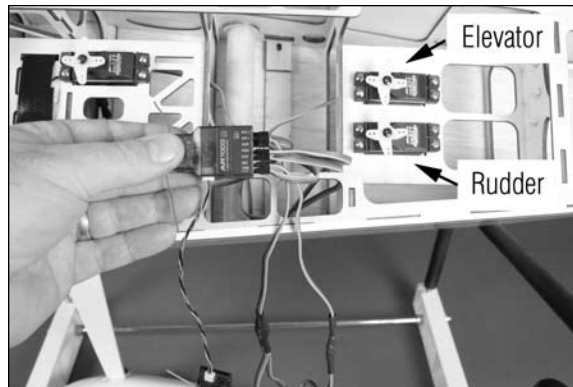

□ Step 9

Use a hook and loop strap and 1/4-inch (6mm) foam rubber (not included) to mount the receiver in the fuselage on the forward servo tray. Also use hook and loop (not included) to mount the remote receiver (if necessary) in the fuselage as shown. It should be as far away from the main receiver as possible and either higher or lower than the main receiver for the best operation of your radio system. Make sure to place a piece of foam between the receiver and strap as shown.

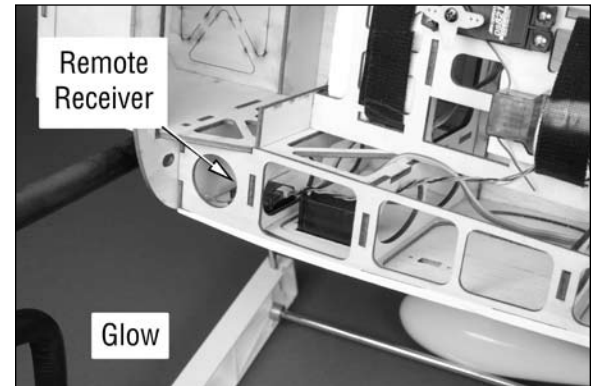
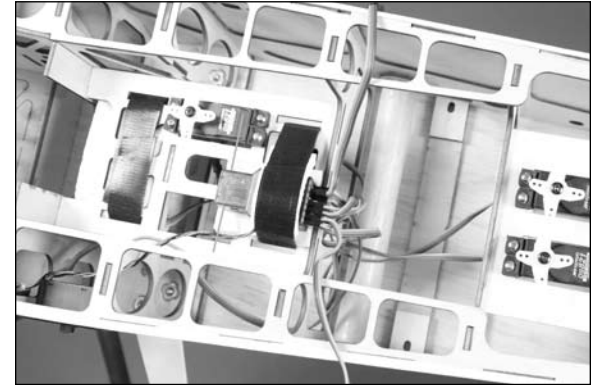

Note: The EP version will require you to mount the main receiver and remote receiver in the locations shown in the photos below to allow for the installation of the motor battery. The receiver is shown with the pins facing up so the majority of the case is supported by the former in the fuselage.

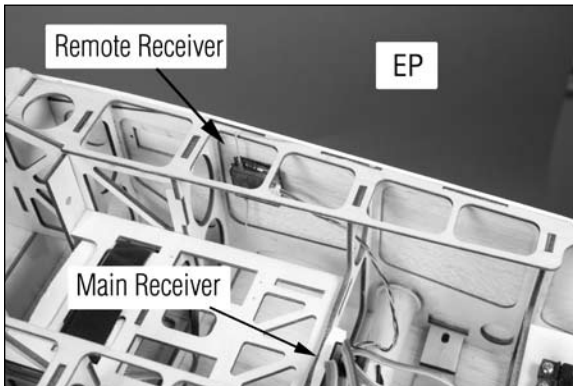
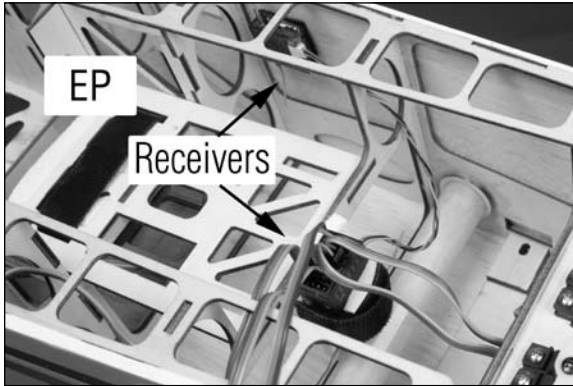

Section 3: Rudder Cable Installation

Required Parts

Fuselage	Rudder cable
Cable crimp (4)	Clevis (2)
Heat shrink tubing	
Pre-bent pull-pull fitting (2)	

Tools and Adhesives

Phillips screwdriver: #2	Crimping tool
Hobby knife with #11 blade	Side cutters
Scissors	Pliers
Pin drill	Drill bit: 5/64-inch (2mm)

Step 1

Use a #2 Phillips screwdriver to remove the servo horns from the rudder and elevator servos.

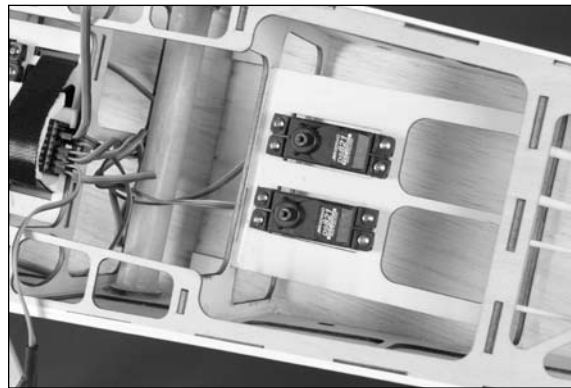

Step 2

Use a pin drill and 5/64-inch (2mm) drill bit to enlarge the holes that are 9/16-inch (15mm) from the center of a 180 degree servo arm as shown. Insert the pre-bent pull-pull fittings in the holes as shown.

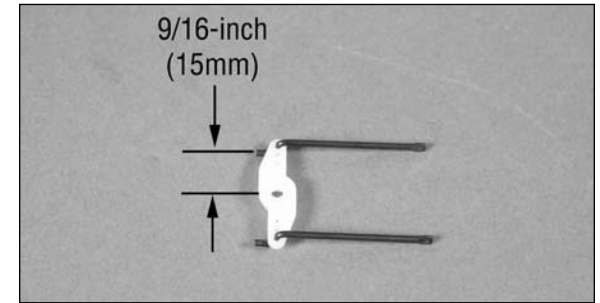

Step 3

Insert one end of the cable into the cable crimp as show. The cable will then go through the hole of the pre-bent pull-pull fitting then back through the cable crimp. Do not cut the cable at this time.

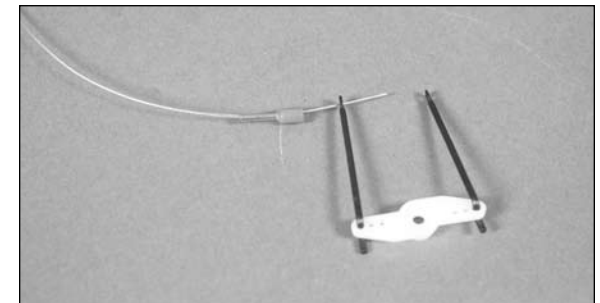
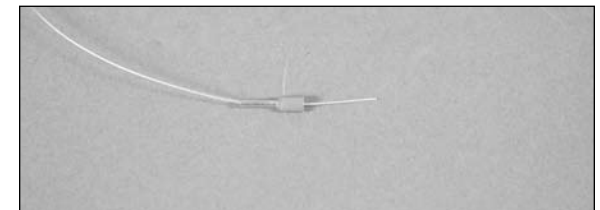

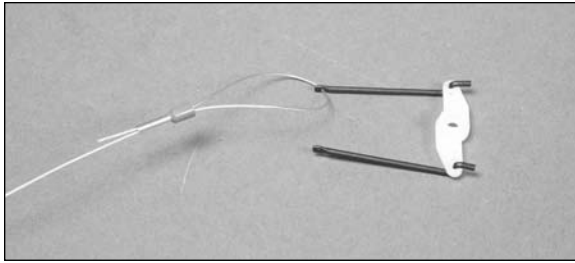

Step 4

Slide the cable crimp close to the fitting, but not so tight that it touches. Position the cable so a small amount exits the crimp. Use crimping pliers or pliers and crimp hard to crimp the cable in position.

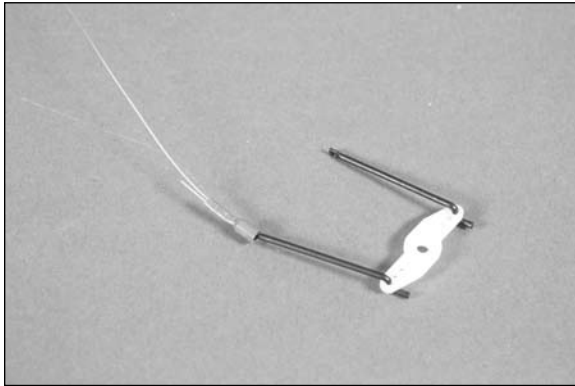

Important: Do not let more than 1/4-inch (6mm) of excess cable exit the crimp.

Step 5

Repeat Steps 3 and 4 to crimp the opposite end of the cable to the remaining pull-pull fitting.

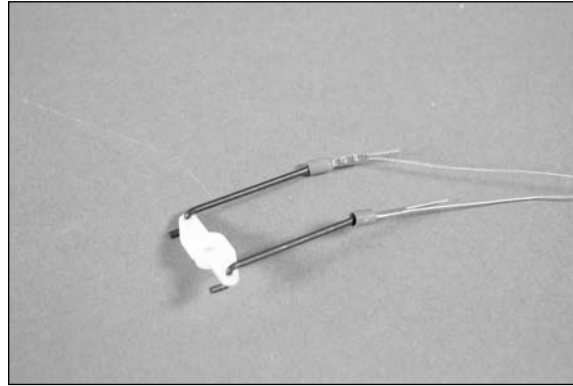

Step 6

While holding the servo arm, pull the cable so you can find the center. Use side cutters to cut the cable in two equal pieces.

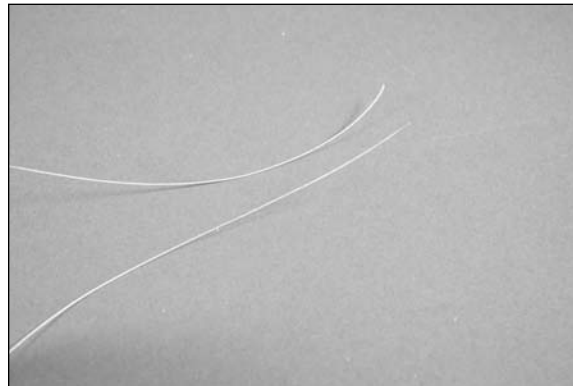

Step 7

Use the radio system to check the operation of the rudder and elevator servos. It may be necessary to bind the transmitter and receiver if you are using a new receiver. Always select a blank model and reset it to remove any programming or trim settings when using a computer radio before starting the linkage installation. Use the screw from the servo and a #2 Phillips screwdriver to secure the servo arm on the rudder servo.

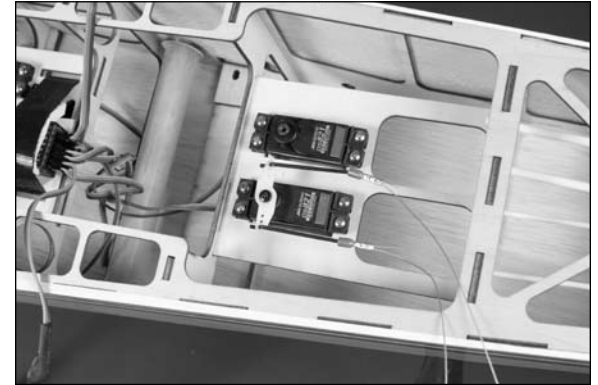

□ Step 8

Slide each of the cables into the tubes inside the fuselage. The cables will exit the fuselage at the rear. You will need to use a hobby knife with #11 blade to remove the covering so the cables can exit.

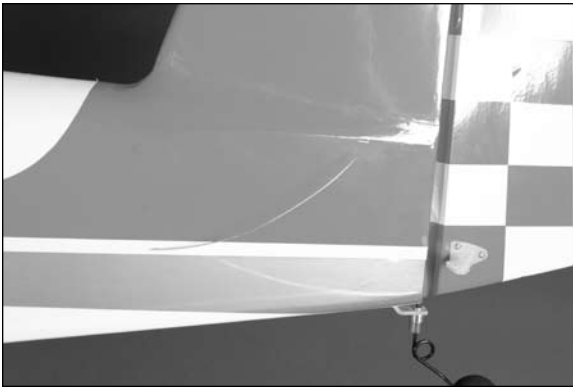
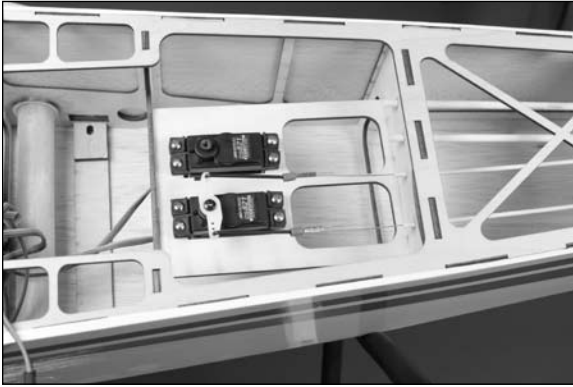

Hint: Poking the cable a few times will make an indentation in the covering so the exit can be located.

□ Step 9

Thread clevis 10-turns on the threaded pull-pull fitting. Use scissors to cut two 1/4-inch (6mm) long pieces from the heat shrink provided and slide it onto the clevis. Prepare two assemblies at this time.

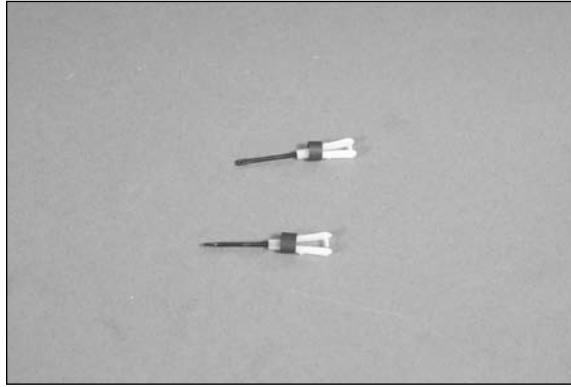

Note: The heat shrink on the clevises will be tightened after the control throws have been set.

□□ Step 10

Connect the clevises to the center hole of the rudder control horns.

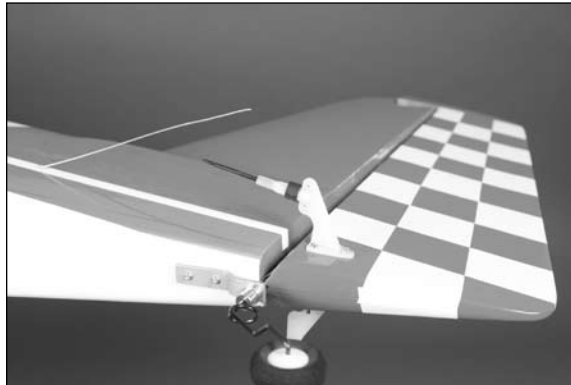

□□ Step 11

Slip the cable through the hole in the fitting. With the radio system on, center the rudder servo. With the rudder centered, pull the cable so it has a light amount of tension. Make a slight bend in the cable as shown. This will help when installing the crimp in the next steps.

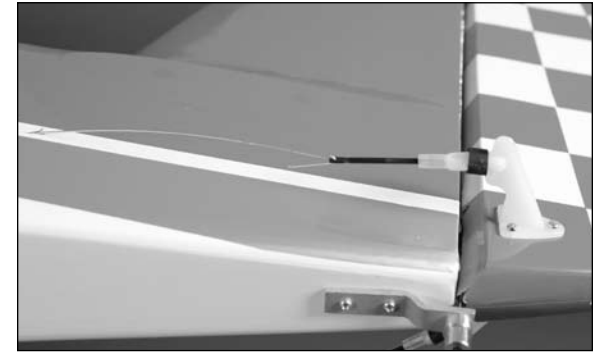

□□ Step 12

Remove the cable, then slide it through the crimp. The cable then goes through the fitting and back through the crimp. Use crimping pliers to secure the crimp to the cable.

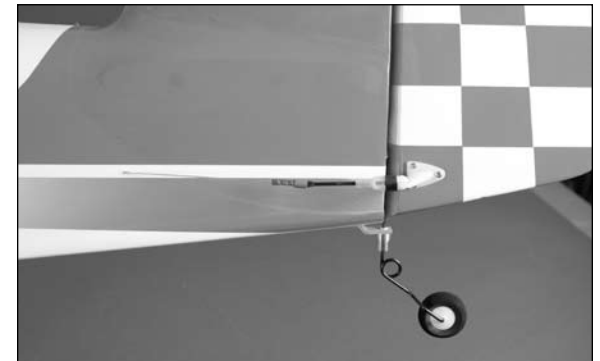

Note: It may be necessary to adjust the tension on the cable from time to time. Simply thread the clevis in or out at the rudder control horn to keep light tension on the cable. Always adjust both clevises equally to avoid changing the rudder trim.

□ Step 13

Repeat Steps 10 through 12 to connect the opposite cable to the rudder control horn.

Section 4: Elevator/Stabilizer Installation

Required Parts

Fuselage	Stabilizer tube (short)
Stabilizer tube (long)	Heat shrink
Clevis (2)	Transmitter
Wheel collar, 4mm (2)	Pushrod keeper
3mm x 3mm setscrew (2)	
29-inch (736mm) pushrod wire (2)	
Stabilizer assembly (right and left)	

Tools and Adhesives

Hobby knife with #11 blade	Felt-tipped pen
Rubbing alcohol	Paper towel
30-minute epoxy	Mixing cup
Mixing stick	Low-tack tape
Epoxy brush	Scissors
Phillips screwdriver: #2	Side cutters
Rotary tool with cutoff wheel	Pliers
Drill bit: 5/64-inch (3mm)	Pin drill
Threadlock	Hex wrench: 1.5mm

Step 1

Use a hobby knife and #11 blade to remove the covering for the two stabilizer tubes in the fuselage on both sides of the fuselage.

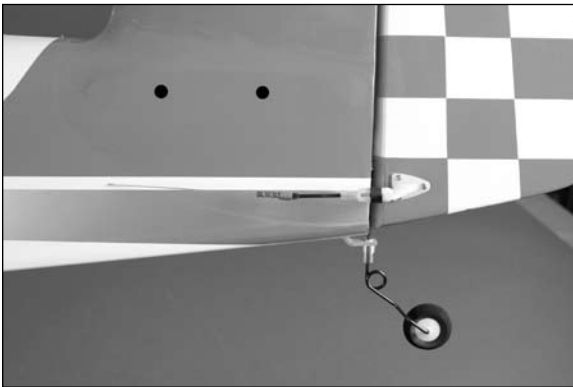

Step 2

Slide the long and short stabilizer tubes into the stabilizer half. Note the longer tube is in the hole toward the leading edge of the stabilizer (front) and the shorter tube toward the elevator (rear).

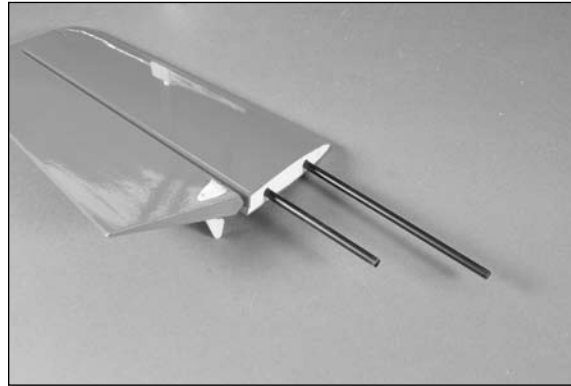

Step 3

Slide the tubes into the fuselage. Use a felt-tipped pen to trace the outline of the stabilizer on the side of the fuselage.



Step 4

Use a hobby knife with a #11 blade to remove the covering from the fuselage. Trim 3/32-inch (2mm) inside the lines drawn when cutting the covering.



Step 5

Repeat Steps 2 through 4 to prepare the opposite side of the fuselage for the stabilizer.

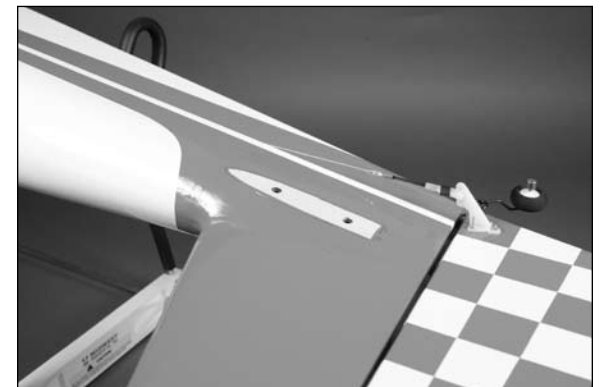

Hint: Use rubbing alcohol and a paper towel to remove the lines drawn on the fuselage.

Important: Read through the next few steps before mixing any epoxy. You must be able to perform these steps before the epoxy begins to cure.

□□ Step 6

Mix a small amount of 30-minute epoxy. Brush a thin coat of epoxy on the exposed wood of the fuselage as well as to the bare wood of the stabilizer.

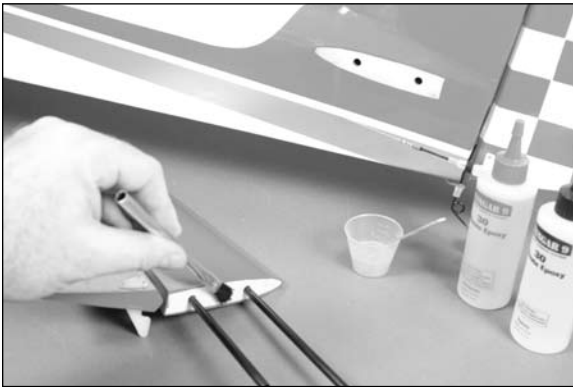
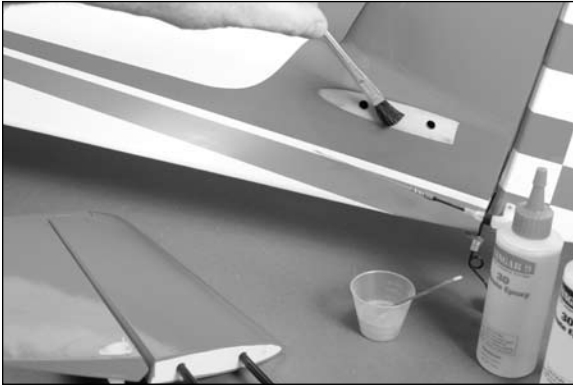

□□ Step 7

Slide the stabilizer into position. Use low-tack tape to keep the stabilizer tight against the fuselage.

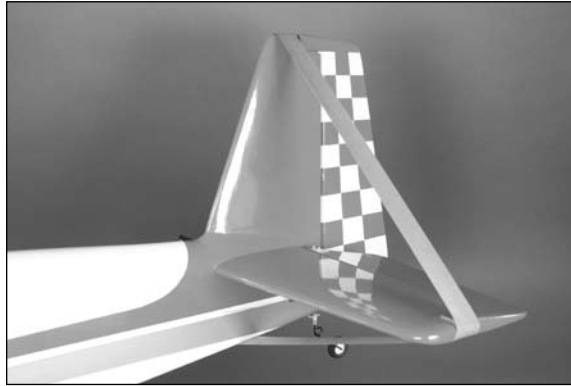

Caution: Make sure to keep the stabilizer perpendicular to the vertical fin when applying the tape. It is possible to have too much tension on the top or bottom and pull the stabilizer out of alignment.

□ Step 8

Repeat Steps 6 and 7 to install the remaining stabilizer half before the epoxy begins to cure.

Hint: Use rubbing alcohol and a paper towel to remove any excess epoxy from the stabilizer and fuselage before it begins to cure.

□ Step 9

After the epoxy has fully cured, slide one of the 29-inch (736mm) pushrod wires, threaded end first, into the elevator pushrod tube closest to the side of the fuselage. Remove the covering at the rear of the fuselage using a hobby knife and #11 blade so the pushrod can exit the fuselage.

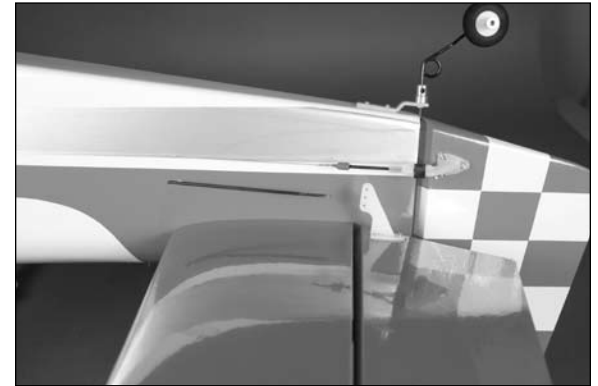
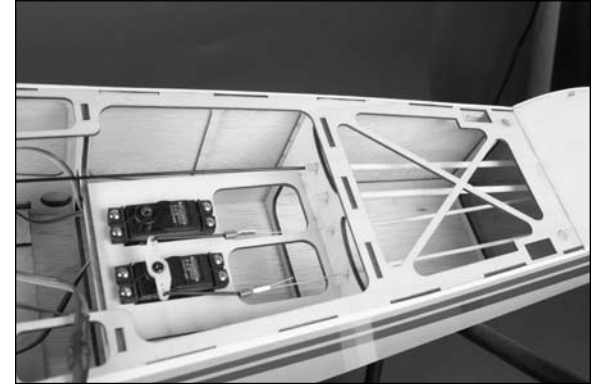

□ Step 10

Cut a 1/4-inch (6mm) piece from the heat shrink tubing and slide it over the clevis. Thread the clevis 10-turns on the pushrod wire. Connect the clevis to the center hole of the elevator control horn.

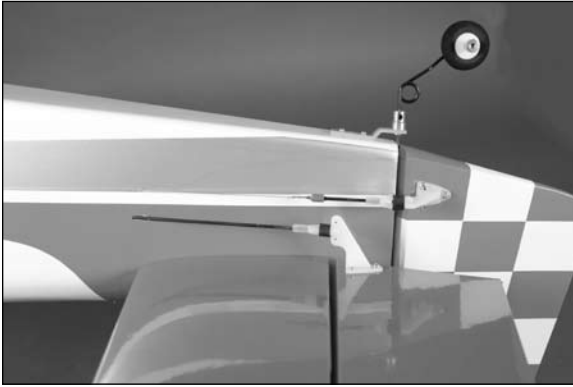

Note: The heat shrink on the clevises will be tightened after the control throws have been set.

□ Step 11

Use side cutters to remove one arm from a long 180 servo arm. Secure the arm on the servo using the screw that was removed previously. Use a #2 Phillips screwdriver to tighten the screw.

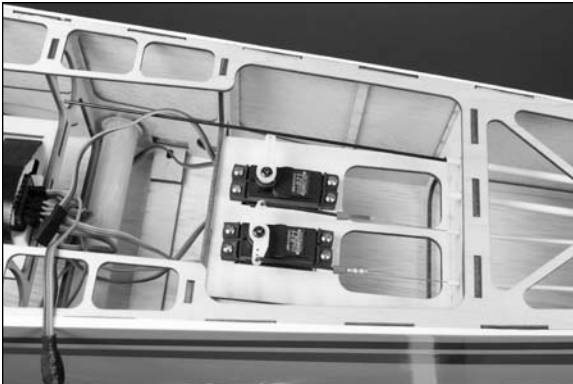

□ Step 12

Turn on the radio system and center the elevator servo. With the elevator centered, use a felt-tipped pen to mark the pushrod wire where it crosses the servo horn.

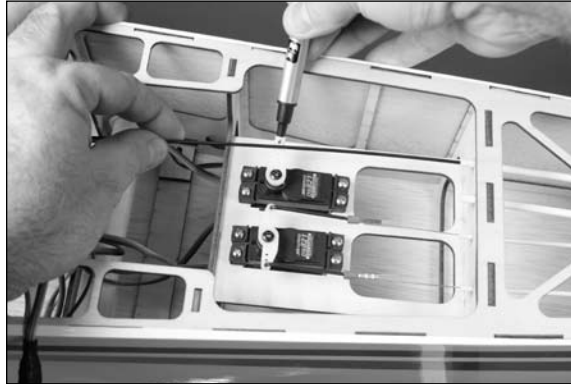

□ Step 13

Use pliers to bend the pushrod wire 90 degrees at the mark made in the previous step.



□ Step 14

Trim the wire 3/8-inch (10mm) above the bend using side cutters or a rotary tool.



□ Step 15

Use a pin drill and 5/64-inch (2mm) drill bit to enlarge the hole that is 9/16-inch (14mm) from the center of the servo arm.

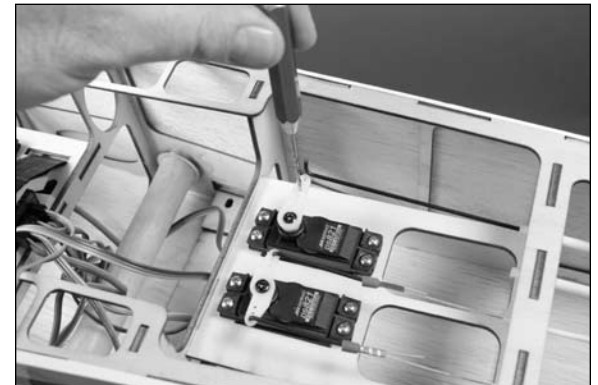

Step 16

Slide two 4mm wheel collars on the pushrod wire.

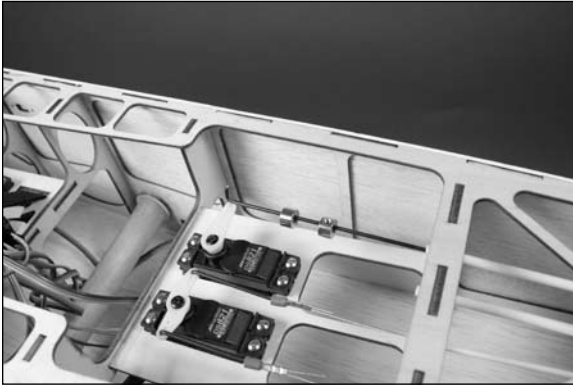

Step 17

Insert the wire into the hole in the servo arm. Slide the pushrod keeper onto the wire, then rotate it and snap it on the wire to secure the pushrod wire to the servo horn.

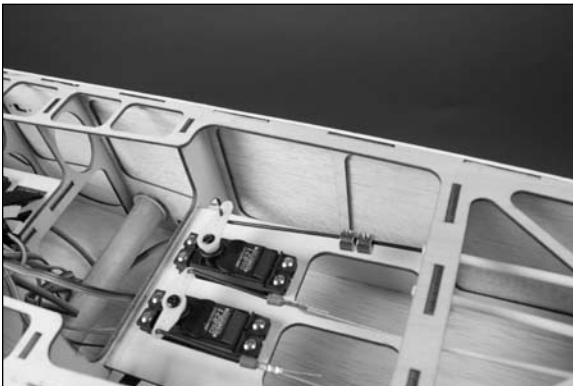

Step 18

Repeat Steps 9 and 10 to install the remaining 29-inch (736mm) pushrod wire.

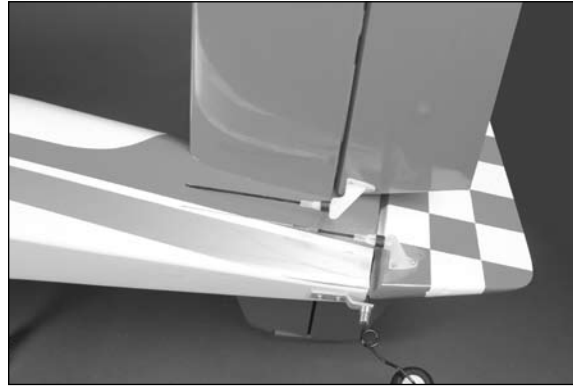

Step 19

You will need to make two 45-degree bends in the elevator pushrod so it can be secured to the first pushrod. Make sure that the bend nearest the pushrod tube is far enough forward that it will not hit the pushrod tube when operating the elevator.



Step 20

Use a rotary tool and cut off wheel or side cutters to trim the pushrod wire so it almost touches the pushrod keeper. Slide the wheel collars forward. Slide the bent pushrod wire into the wheel collars.

Step 21

Use two 3mm x 3mm setscrews and a 1.5mm hex wrench to secure the collars that link the two pushrods together. Make absolute sure to use threadlock on these screws so they don't vibrate loose.

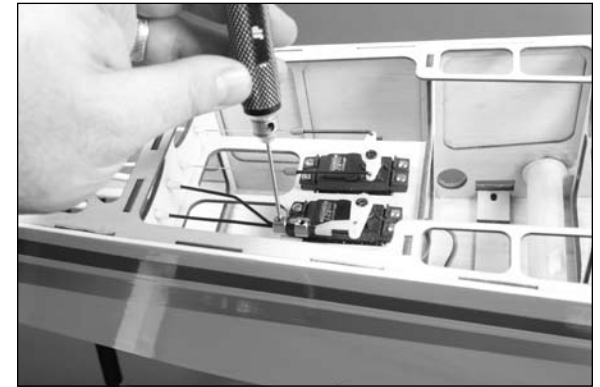

Section 5: 2-Stroke Engine Installation

Required Parts

Fuselage	Engine mounting template
#8 washer (4)	8-32 blind nut (4)
4-40 locknut (4)	#4 washer (4)
Engine	
4-40 x 1-inch socket head screw (4)	
Throttle pushrod, 16-inch (406mm)	
Throttle pushrod tube, 8-inch (203mm)	
8-32 x 3/4-inch socket head screw (4)	

Tools and Adhesives

Drill	Low-tack tape
Phillips screwdriver: #1	Ruler
Medium grit sandpaper	Side cutters
Medium CA	Threadlock
30-minute epoxy	
Hex wrench or ball driver: 3/32-inch, 9/64-inch	
Nut driver or box wrench: 1/4-inch	
Drill bit: 1/16-inch (1.5mm), 5/32-inch (4mm), 7/32-inch (5.5mm)	

□ Step 1

Cut the engine mounting template from Page 47 of the manual or use the supplied plywood template. Use low-tack tape to attach it to the front of the firewall as shown.



□ Step 2

Use a drill and 1/16-inch (1.5mm) drill bit to drill the appropriate holes for your particular motor. The throttle pushrod locations are also located on the template for both Saito and Evolution engines.

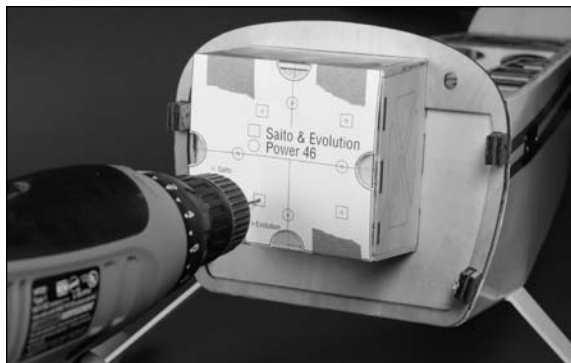
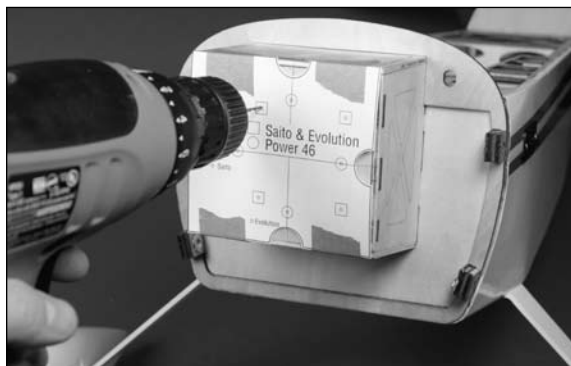

Hint: Use a #1 Phillips screwdriver or center punch to make an indentation in the firewall so the drill bit does not wander when drilling the holes.

□ Step 3

Use a drill and 7/32-inch (5.5mm) drill bit to enlarge the four holes used to mount the motor mount to the firewall. Use a drill and 5/32-inch (4mm) drill bit to enlarge the hole for the pushrod tube.

□ Step 4

Use a drill and 5/32-inch (4mm) drill bit to drill a hole 3/4-inch up and centered in the plywood as shown.

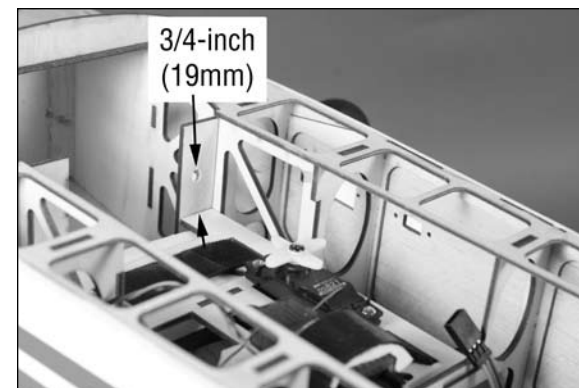

□ Step 5

Use medium grit sandpaper to roughen the last 1 1/4-inch (32mm) on both ends of outside of the 8-inch (203mm) throttle pushrod tube. Insert the tube through the two holes so 1-inch (25mm) of the tube extends past the former toward the servo as shown. Use medium CA to glue the tube to the former and firewall.

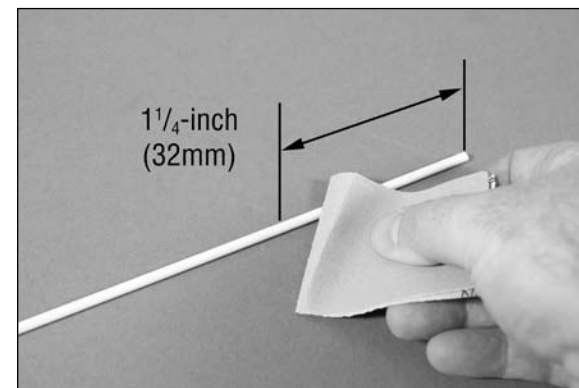

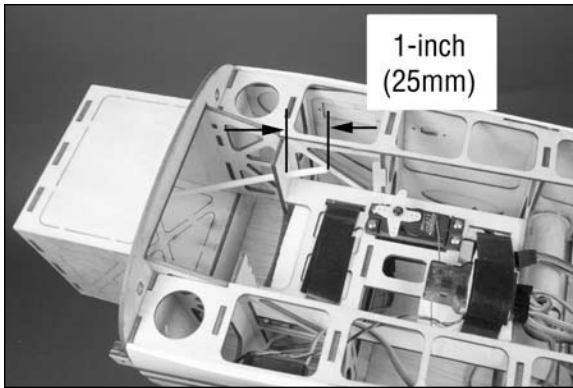

□ Step 6

Use a 9/64-inch hex wrench and one of the 8-32 x 3/4-inch socket head screws and a #8 washer to draw the four 8-32 blind nuts into the backside of the firewall. Note that the barbs on the blind nuts face the wood and keep the blind nuts from rotating or falling out.

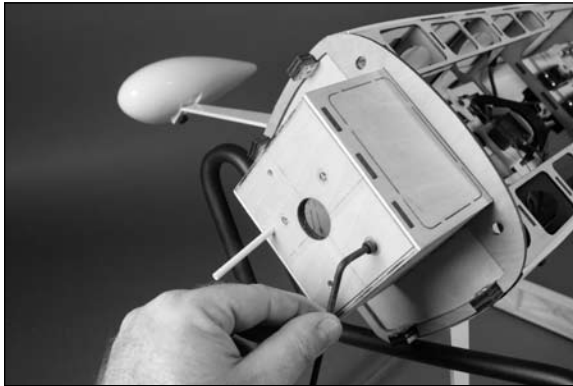

Hint: Apply a couple drops of medium CA to the barbs of the blind nut before installing. This will help to keep the blind nut secure should you ever need to remove the screw.

□ Step 7

Attach the motor mounts to the firewall using four 8-32 x 3/4-inch socket head screws and four 8-32 washers. Use a 9/64-inch hex wrench to lightly tighten the screws. You should be able to move the mounts so their position can be fine-tuned for your particular engine. Apply a drop of threadlock on each of the screws to prevent them from vibrating loose.

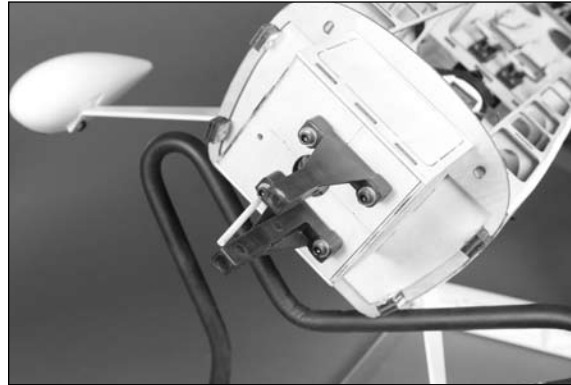

□ Step 8

Connect the Z-bend on the 16-inch (406mm) pushrod to the carburetor as shown.



□ Step 9

Use the holes in the engine mount that will position the drive washer of the engine 4³/₈ inches (111mm) from the firewall as shown. Tighten the screws that attach the mount to the firewall after making sure they have threadlock on them to keep them from vibrating loose.

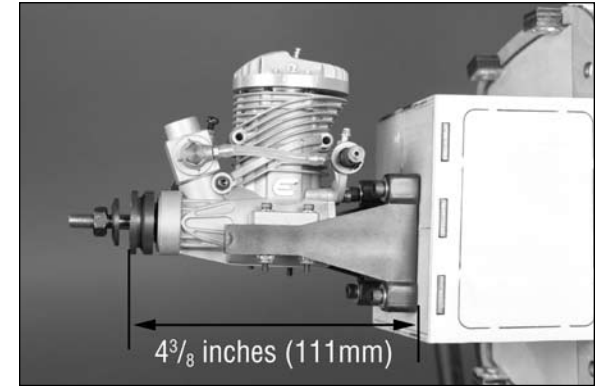

□ Step 10

Slide the pushrod into the pushrod tube. Position the engine between the mounts, then secure its position using four 4-40 x 1-inch socket head screws, four #4 washers and four 4-40 locknuts. Place the washers on the bottom side of the mount between the mount and lock nuts. Use a 1/4-inch nut driver or box wrench to hold the locknuts while tightening the socket head screws with a 3/32-inch hex wrench or ball driver.

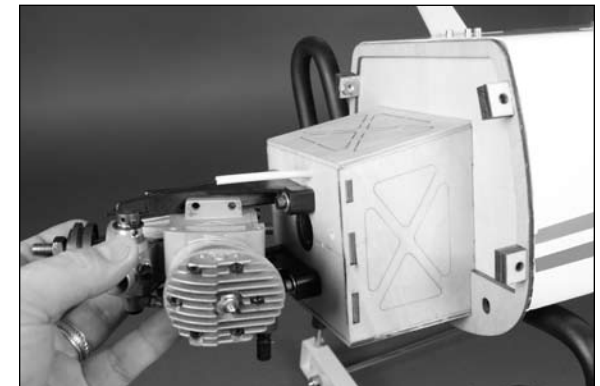

Section 6: 4-Stroke Engine Installation

Required Parts

Fuselage	Engine mounting template
#8 washer (4)	8-32 blind nut (4)
4-40 locknut (4)	#4 washer (4)
Engine	
7/16-inch (11mm) 2-stroke spacer (2)	
4-40 x 1-inch socket head screw (4)	
Throttle pushrod, 16-inch (406mm)	
Throttle pushrod tube, 8-inch (203mm)	
8-32 x 3/4-inch socket head screw (4)	

Tools and Adhesives

Drill	Low-tack tape
Phillips screwdriver: #1	Ruler
Medium grit sandpaper	Side cutters
Medium CA	Threadlock
Rotary tool with sanding drum	
Hex wrench or ball driver: 3/32-inch, 9/64-inch	
Nut driver or box wrench: 1/4-inch	
Drill bit: 1/16-inch (1.5mm), 5/32-inch (4mm), 7/32-inch (5.5mm)	

□ Step 1

Cut the engine mounting template from Page 47 of the manual or use the supplied plywood template. Use low-tack tape to attach it to the front of the firewall as shown.



□ Step 2

Use a drill and 1/16-inch (1.5mm) drill bit to drill the appropriate holes for your particular motor. The throttle pushrod locations are also located on the template for both Saito and Evolution engines.

Hint: Use a Phillips screwdriver or center punch to make an indentation in the firewall so the drill bit does not wander when drilling the holes.

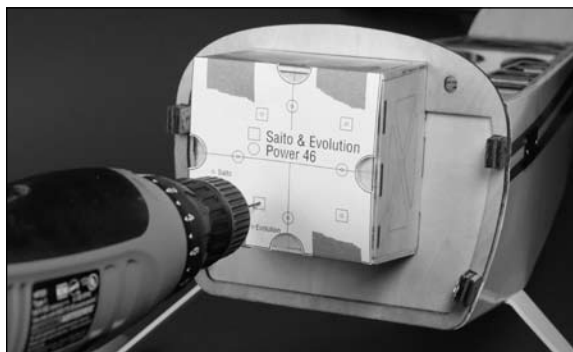
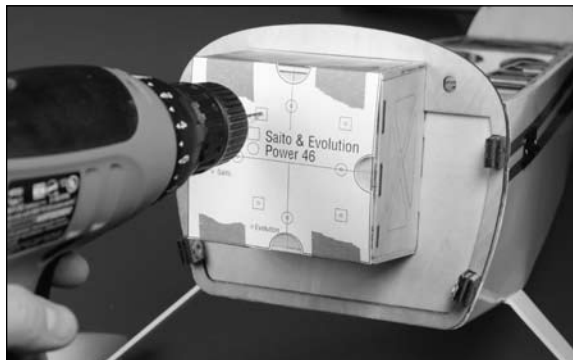

□ Step 3

Use a drill and 7/32-inch (5.5mm) drill bit to enlarge the four holes used to mount the motor mount to the firewall. Use a drill and 5/32-inch (4mm) drill bit to enlarge the hole for the pushrod tube.

□ Step 4

Use a drill and 5/32-inch (4mm) drill bit to drill a hole 3/4-inch up and centered in the plywood as shown.

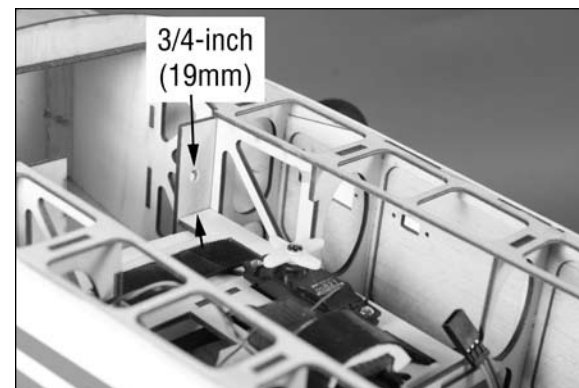

□ Step 5

Use medium grit sandpaper to roughen the last 1 1/4-inch (32mm) on both ends of outside of the 8-inch (203mm) throttle pushrod tube. Insert the tube through the two holes so 1-inch (25mm) of the tube extends past the former toward the servo as shown. Use medium CA to glue the tube to the former and firewall.

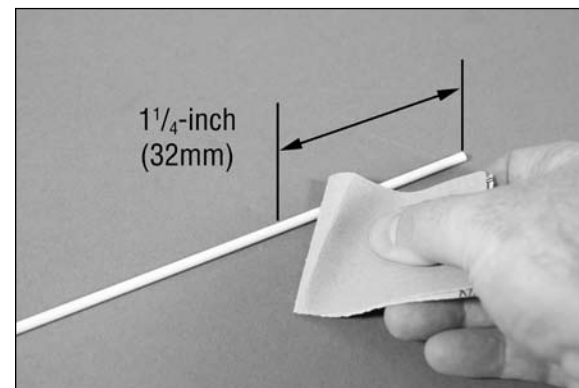

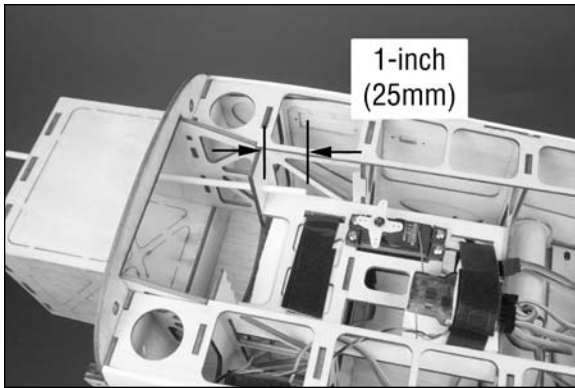

□ Step 6

Use a 9/64-inch hex wrench and one of the 8-32 x 3/4-inch socket head screws and a #8 washer to draw the four 8-32 blind nuts into the backside of the firewall. Note that the barbs on the blind nuts face the wood and keep the blind nuts from rotating or falling out.



□ Step 7

Test fit the engine to the mount. You will need to use a rotary tool and sanding drum to remove a small amount of material from the engine mount to clear the carburetor as shown in the following images.

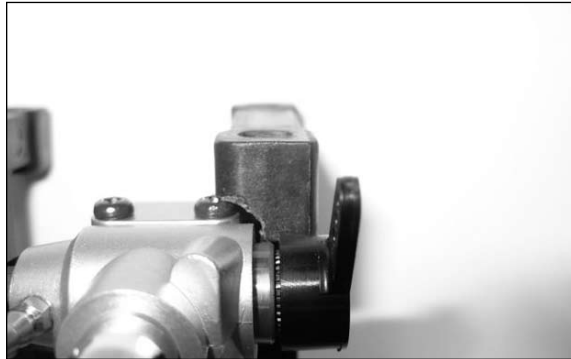

□ Step 8

Connect the Z-bend on the 16-inch (406mm) pushrod to the carburetor as shown.

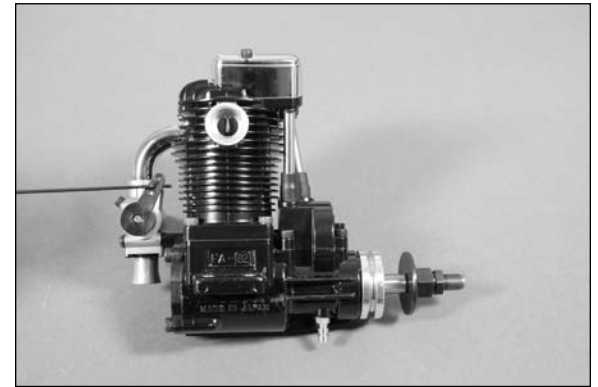

Note: When connecting the pushrod to the four-stroke, make note the direction of the carburetor. It does not match to that in the photo, follow the instructions provided with the engine to rotate the carburetor 180 degrees.

□ Step 9

Attach the motor mounts to the firewall using four 8-32 x 3/4-inch socket head screws and four #8 washers. Use a 9/64-inch hex wrench to lightly tighten the screws. You should be able to move the mounts so their position can be fine-tuned for your particular engine.

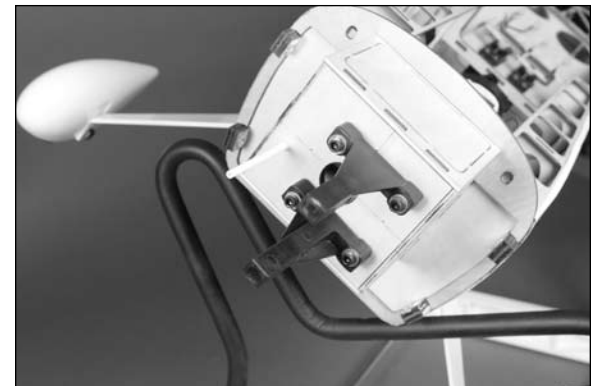

Step 11

Trim the throttle pushrod tube as close to the firewall as possible using side cutters. This is necessary as the throttle arm is very close to the firewall when the carburetor is fully closed.

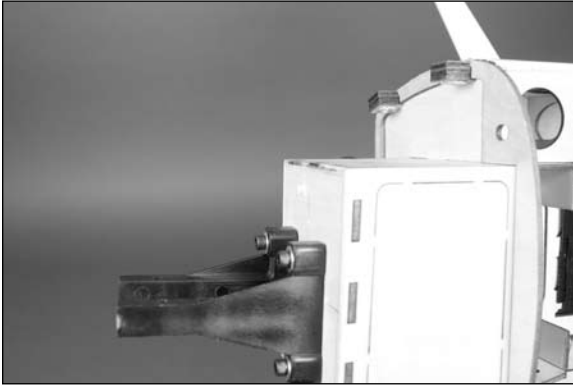

Step 12

Use the holes in the engine mount that will position the drive washer of the engine $4\frac{3}{8}$ inches (111mm) from the firewall as shown. Tighten the screws that attach the mount to the firewall after making sure they have threadlock on them to keep them from vibrating loose.

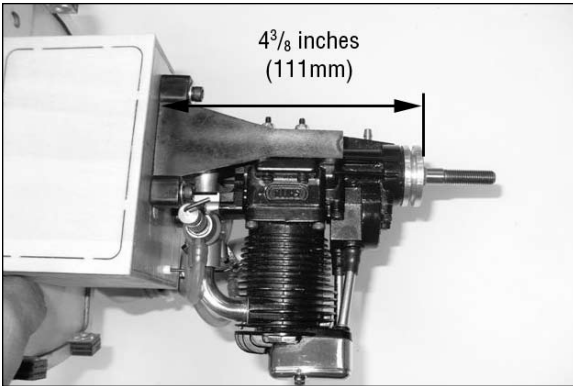

Step 13

Slide the pushrod into the pushrod tube. Position the engine between the mounts, then secure its position using four 4-40 x 1-inch socket head screws, four #4 washers and four 4-40 locknuts. Place the washers on the bottom side of the mount between the mount and lock nuts. Use a 1/4-inch nut driver or box wrench to hold the locknuts while tightening the socket head screws with a 3/32-inch hex wrench or ball driver.

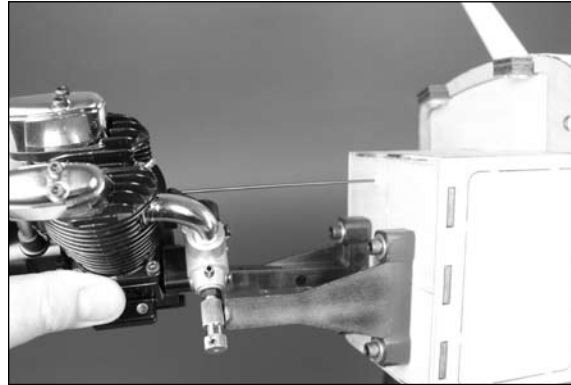

Section 7: Fuel Tank Installation and Throttle Linkage Connection

Required Parts

Fuselage	Pushrod connector
2mm washer	E-clip
Transmitter	3mm x 3mm setscrew
Fuel tank	Plywood tank support
Engine muffler	Fuel dot (optional)

Tools and Adhesives

Phillips screwdriver: #2	Side cutters
Pin drill	Drill bit: 5/64-inch (2mm)
Foam rubber, 1/4-inch (6mm)	Threadlock
Medium CA	
Hex wrench or ball driver: 1.5mm	

Step 1

Use a pin drill and 5/64-inch (2mm) drill bit to enlarge the hole that is 1/2-inch (13mm) from the center of the throttle servo arm.

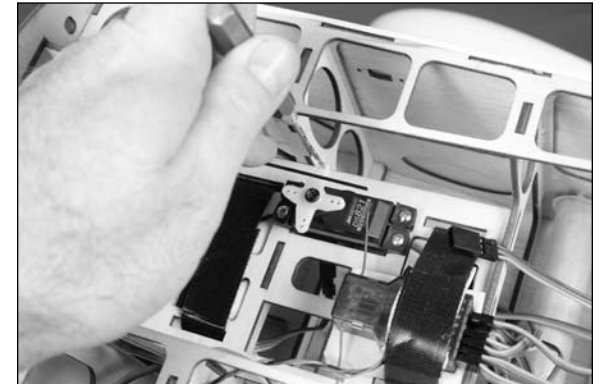

□ Step 2

Remove the servo horn from the servo using a #2 Phillips screwdriver. Use side cutters to remove the excess servo arms so they will not interfere with the operation of the servo.

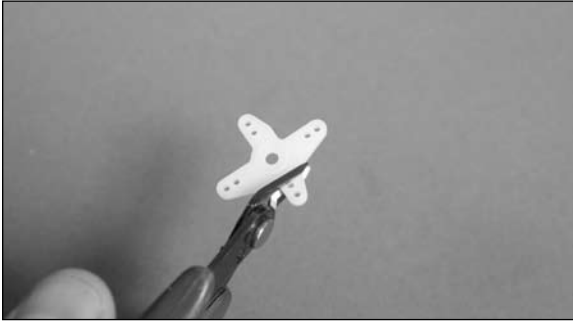

□ Step 3

Insert the pushrod connector in the hole drilled in Step 1. Use a 2mm washer and E-clips to secure the connector to the servo horn.

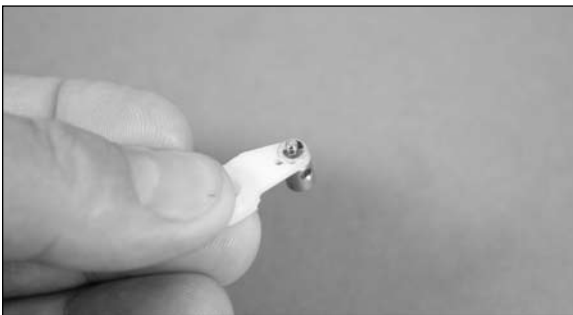
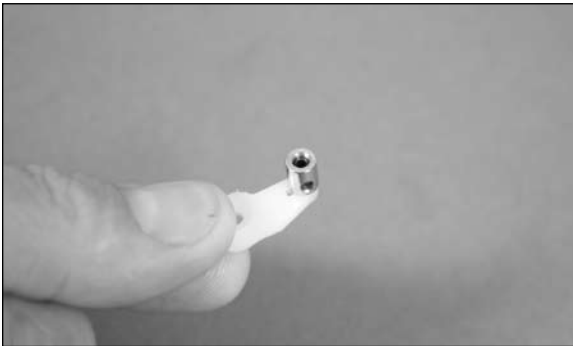

□ Step 4

Slide the connector on the pushrod wire then secure the servo horn to the servo using a #2 Phillips screwdriver and the screw that was removed in Step 2. Use the radio system to move the throttle servo to the low throttle position.



□ Step 5

Move the pushrod wire to close the carburetor. With a 1.5mm hex wrench, use a 3mm x 3mm setscrew to secure the pushrod wire to the pushrod connector. Remember to use threadlock on the setscrew to prevent it from vibrating loose.

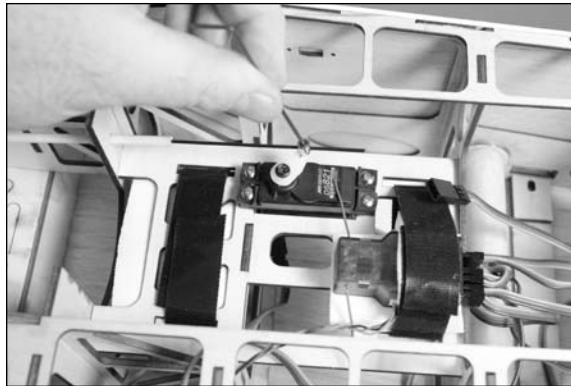

□ Step 6

Check the operation of the throttle using the radio system. You should be able to move from closed to open using the radio without any binding. If there isn't enough throw, move the connection of the pushrod at the carburetor to the center of the carburetor arm. If there is too much throw, move the connection at the carburetor out from center or more to the center of the servo horn. If you are using a computer radio, you can also use Travel Adjust to fine-tune the throw.

Note: It may be necessary to make a slight bend in the throttle pushrod near the servo for alignment purposes.

□ Step 7

Inspect the fuel tank according to the following drawing to determine the vent and clunk lines on the tank. The vent line must face up when installing the tank or the engine will not operate properly.

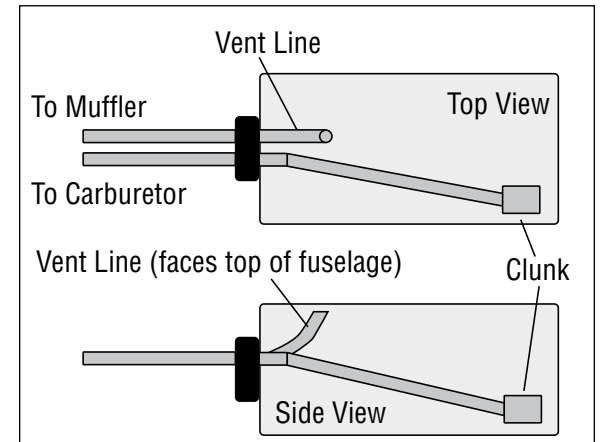

□ Step 8

Cut a 1/2-inch (12mm) wide piece of 1/4-inch (6mm) foam and wrap it around the fuel tank as shown.



Hint: Using strapping tape around the foam will help when sliding the tank into the fuselage. Use very light pressure when applying the tape to avoid compressing the foam against the tank.

□ Step 9

Insert the fuel tank in the fuselage. Again, make sure the vent line faces to the top of the fuselage when installing the tank. Place a piece of foam at the rear of the tank so it will not slide rearward in the fuselage.

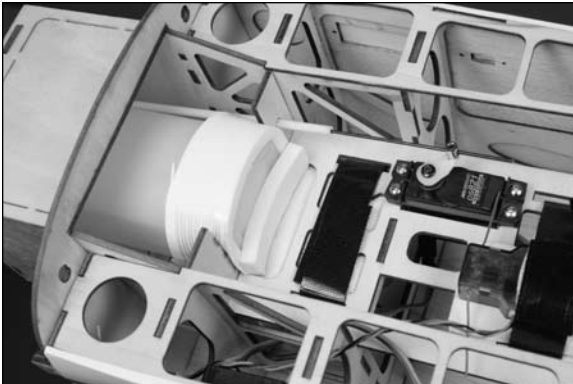

□ Step 10

Use medium CA to glue the plywood tank support in position. Make sure the top of the support is flush with the top of the formers or the canopy hatch will not fit back on the fuselage correctly.

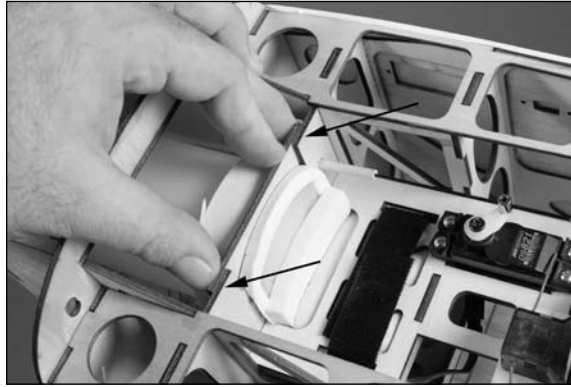

□ Step 11

Follow the instructions provided with your engine to install the muffler.

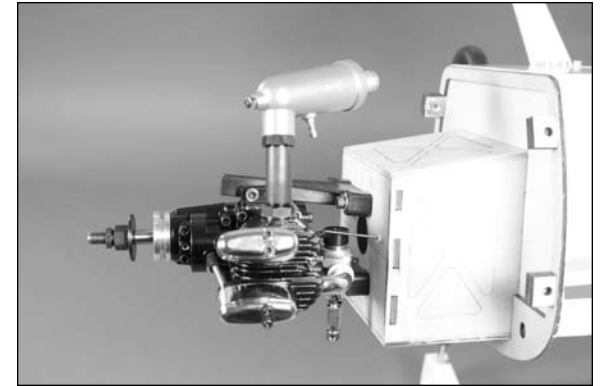

□ Step 12

Connect the fuel lines to the engine. Note that the vent line will connect to the muffler, and the line from the clunk connects to the fuel inlet.

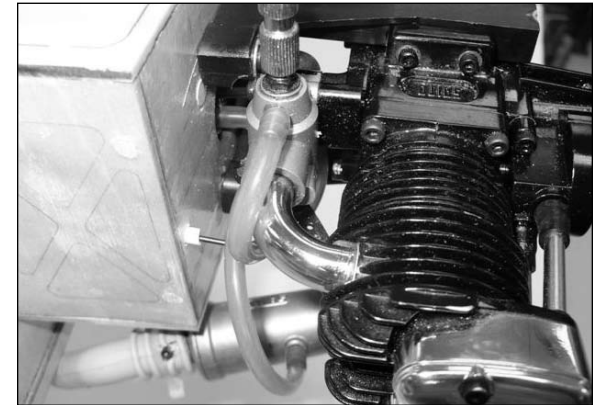

Note: We used a fuel dot so the fuel tank can be filled without the need to remove the cowl.

Section 8: Electric Motor Installation

Required Parts

Fuselage	Engine mounting template
Motor with mount	Speed control
Motor battery	
12-inch (305mm) servo extension	
Aluminum motor standoff, 1 $\frac{1}{8}$ -inch (42mm) (4)	
#8 washer (4)	
8-32 x 3/4-inch socket head screw (8)	

Tools and Adhesives

Hobby knife with #11 blade	Drill
Hook and loop tape	Tie wrap
Phillips screwdriver: #2	Threadlock
Hook and loop strap	Ruler
Low-tack tape	
Hex wrench or ball driver: 9/64-inch	
Nut driver or box wrench: 1/4-inch	
Drill bit: 1/16-inch (1.5mm), 11/64-inch (4.5mm)	

□ Step 1

Cut the engine mounting template from Page 47 of the manual or use the supplied plywood template. Use low-tack tape to attach it to the front of the firewall as shown.



□ Step 2

Use a drill and 1/16-inch (1.5mm) drill bit to drill the appropriate holes for the motor.

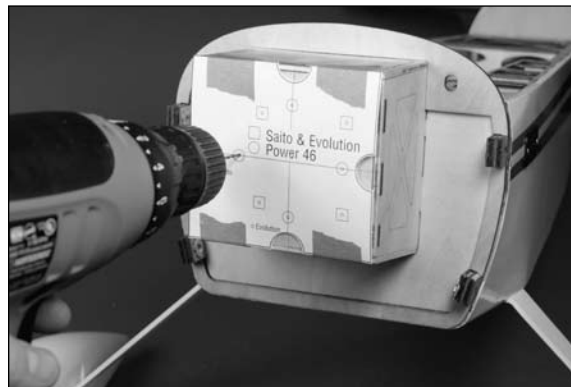

□ Step 3

Use a drill and 11/64-inch (4.5mm) drill bit to enlarge the holes for mounting the motor.

□ Step 4

Use a hobby knife and #11 blade to remove the plywood from the engine box to allow cooling air to flow into the fuselage for the battery.

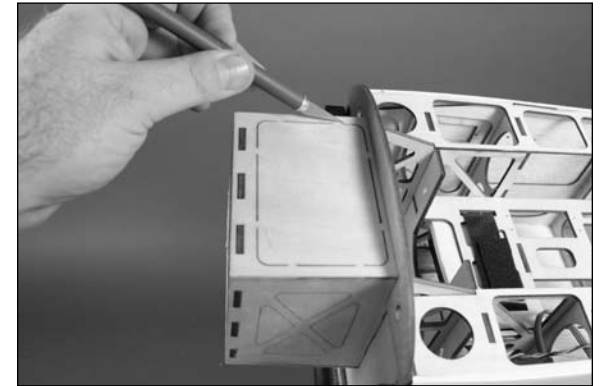

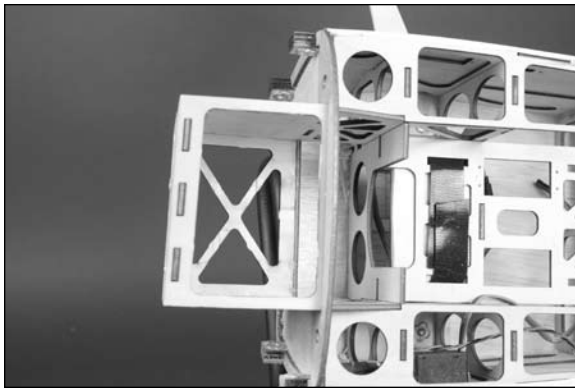

□ Step 5

Attach the four 1⁵/₈-inch (42mm) aluminum motor standoffs to the firewall using four 8-32 x 3/4-inch socket head screws and four #8 washers. The screws will be on the inside of the fuselage so you will want to have a 9/64-inch ball driver handy to tighten the screws.

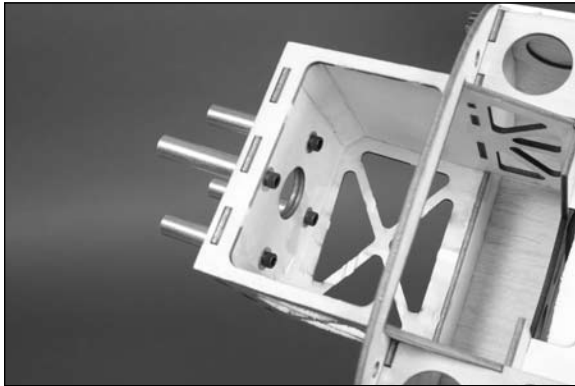

□ Step 6

Use a drill and 11/64-inch (4.5mm) drill bit to enlarge the mounting holes in the motor mount plate.

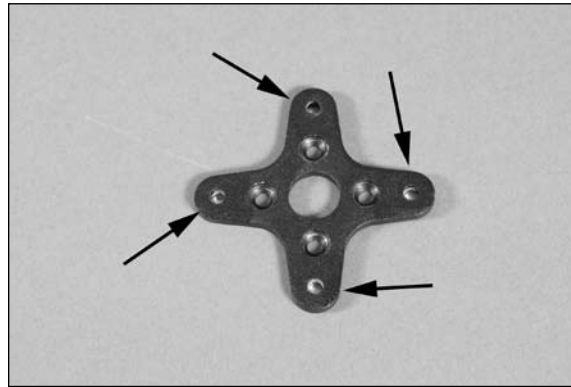

Note: It is highly recommended to use a drill press and secure the mount. Use caution when using a hand drill as the mount can easily rotate if the drill bit catches on the aluminum during the drilling process.

□ Step 7

Use a #2 Phillips screwdriver to attach the mount to the motor using the hardware included with the motor. Make sure to use threadlock on the screws to prevent them from vibrating loose.



□ Step 8

Use a 9/64-inch hex wrench or ball driver to tighten the four 8-32 x 3/4-inch socket head screws that attach the motor to the standoffs. Make sure to use threadlock on all the hardware attaching the motor and standoffs.



□ Step 9

Use hook and loop tape (not included) and a tie wrap (not included) to secure the speed control to the motor box. Plug the leads together from the speed control and motor, routing them as necessary so they will not interfere with the operation of the motor.

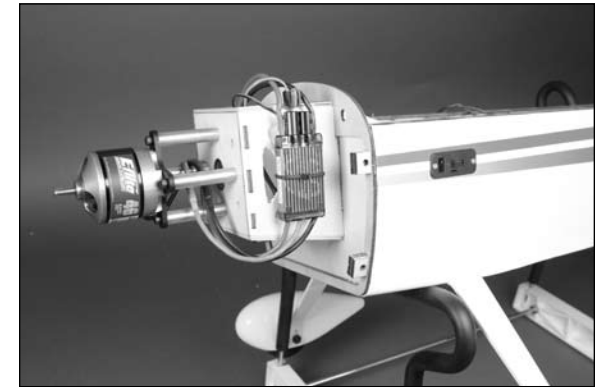

□ Step 10

The battery is mounted inside the fuselage using hook and loop straps. The position of the battery can be moved forward or aft to adjust the Center of Gravity of your model once it has been completely assembled.



Note: If you are using the new Thunder Power Generation 2 batteries or equivalent then the cooling hole is not mandatory, but strongly recommended.

□ Step 11

Use a hobby knife with a #11 blade and ruler to cut the air cooling template from Page 47 of this manual.

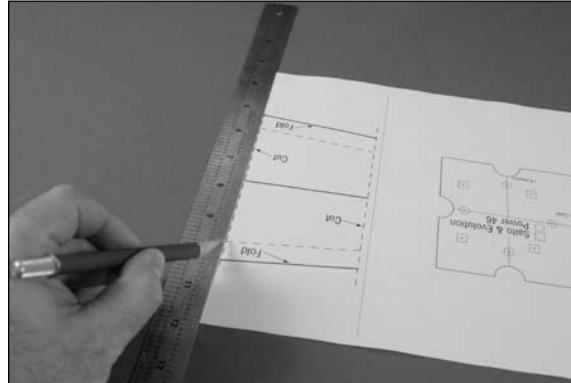

□ Step 12

Carefully fold the template along the fold lines. This will assist in positioning the template on the bottom of the fuselage.

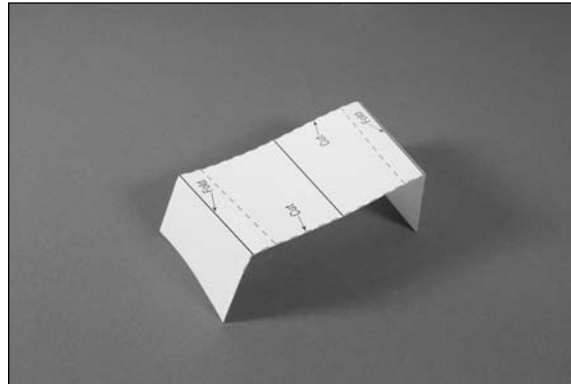

□ Step 13

Use a ruler to measure back $17\frac{3}{4}$ -inches (450mm) back from the point on the fuselage shown in the photo below.

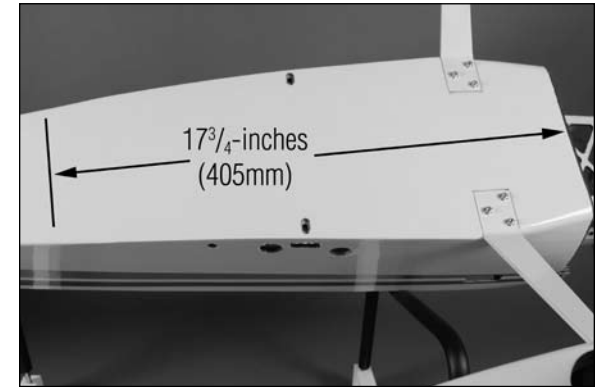

□ Step 14

Position the template so the front edge is at the mark made in the previous step. The folds will help in centering the template on the bottom of the fuselage. Use low-tack tape to secure the template to the bottom of the fuselage.

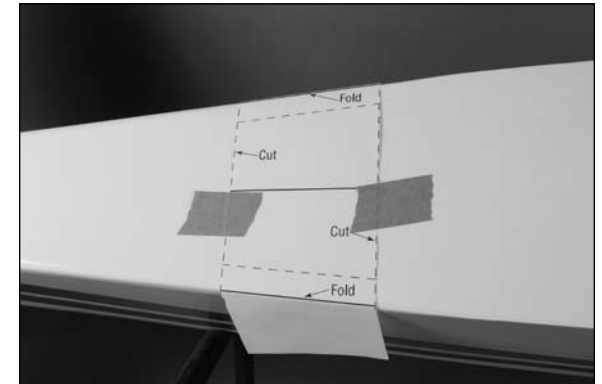

□ **Step 15**

Use a felt-tipped pen to mark the corners for the opening on the bottom of the fuselage using the template as a guide.

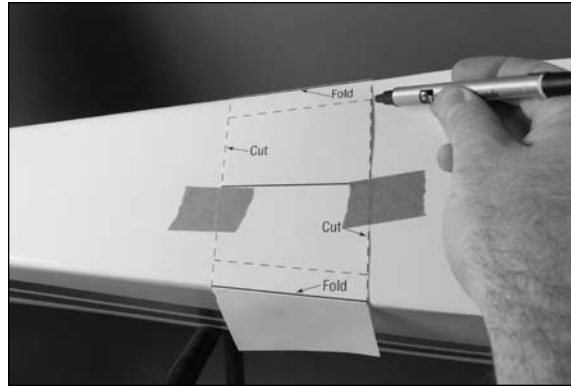
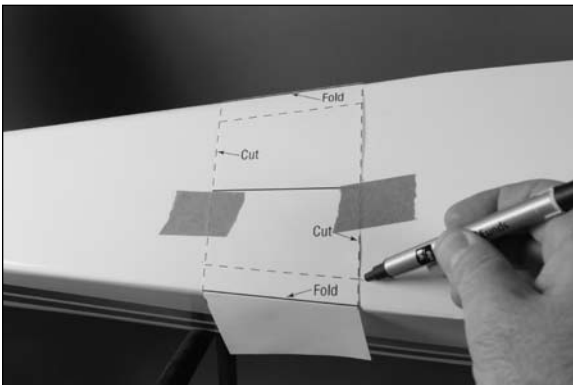
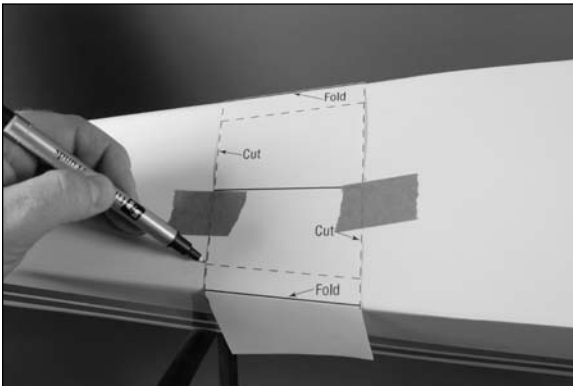
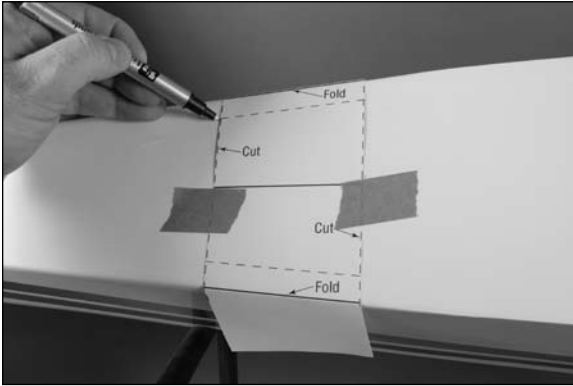

□ **Step 16**

Remove the template from the fuselage. Use a hobby knife and #11 blade to cut through the wood on the bottom of the fuselage using the marks on the bottom of the fuselage as a guide. Work slowly to not let the knife slip and cut more than necessary.



□ **Step 17**

The air exit should be easily lifted from the fuselage once the wood has been cut through. Use a sealing iron to seal the covering if you find it loose after cutting the opening.

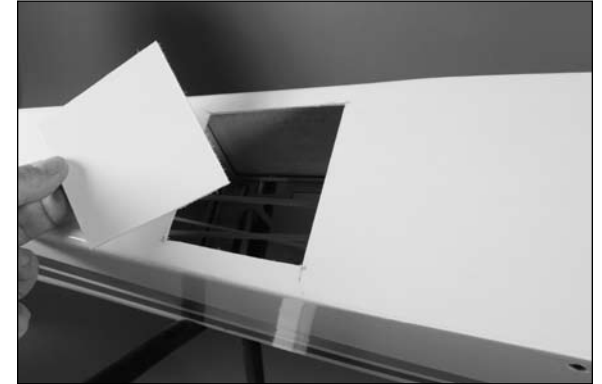

Section 9: Cowling and Spinner Installation

Required Parts

Fuselage	Cowling
3mm washer (4)	Fuel tubing
Propeller	Exhaust diverter (optional)
Spinner with hardware (not included)	
Propeller adapter (EP version)	
3mm x 15mm socket head screw (4)	

Tools and Adhesives

Box wrench to fit propeller nut	
Hex wrench or ball driver: 2.5mm	
Phillips screwdriver: #2	Hobby scissors
Rotary tool with sanding drum	

Step 1

Use hobby scissors and a rotary tool with sanding drum to open the inlets of the cowling as shown.



Step 2

Slide the cowl in position on the fuselage. Use four 3mm x 15mm socket head screws and four 3mm washers to secure the cowling to the fuselage. Use a 2.5mm hex wrench or ball driver to tighten the screws.



Hint: Cut a small 1/4-inch (6mm) piece of fuel tubing and slide it on the screw after the washer. This will help keep the cowl screws from vibrating loose.

Step 3

Slide the propeller adapter on the motor shaft if you are using an electric motor.



Step 4

Slide the spinner back plate (not included) on the motor shaft. It may be necessary to install the correct insert to fit the shaft of your motor or engine.



Step 5

Slide the propeller on the motor shaft. Make sure to balance your propeller before and after if you must enlarge the hole to fit the shaft of your engine.



☐ **Step 6**

Thread the nut on the motor shaft. Make sure to tighten the nut that secures the propeller properly. A box wrench is recommended when flying with a glow motor.



☐ **Step 7**

Attach the spinner cone (not included) using the hardware provided with the spinner.



☐ **Step 8**

Make any necessary cutouts for the needle valve, muffler and cooling outlet for your glow engine installation.

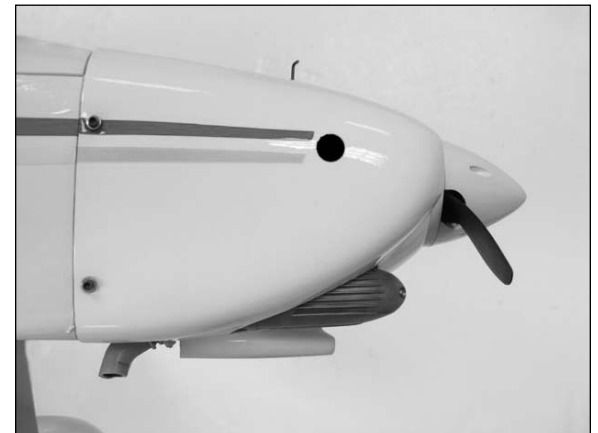



Section 10: Canopy and Pilot Installation

Required Parts

Fuselage	Cockpit hatch
Canopy	
Pilot figure (not included) (HAN9161 or HAN9162 recommended)	

Tools and Adhesives

Felt-tipped pen	Hobby scissors
Mixing stick	30-minute epoxy
Mixing cup	Epoxy brush
Rotary tool with cutoff wheel	Razor saw
Canopy glue	
Sanding bar with medium grit sandpaper	

Step 1

Use hobby scissors to trim the canopy along the molded line to match the one shown in the photo. Use medium grit sandpaper to clean up and rough edges left after cutting.

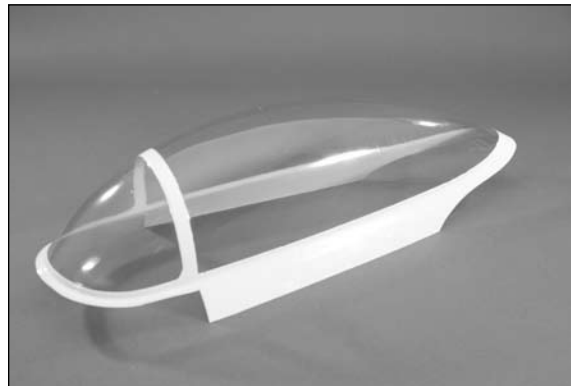

Step 2

You will need to cut the pilot (not included) down roughly 1/4-inch (6mm) to fit inside the cockpit. Use a felt-tipped pen taped to a mixing stick or other item that spaces your pen up 1/4-inch (6mm) from the work surface. Trace around the bottom of the pilot to provide a cutting line.



Step 3

Use a rotary tool and cutoff wheel to cut through the outer plastic of the pilot. A razor saw will be required to cut through the foam inside the pilot. Finish up by sanding the bottom of the pilot flat using a sanding bar and medium grit sandpaper.

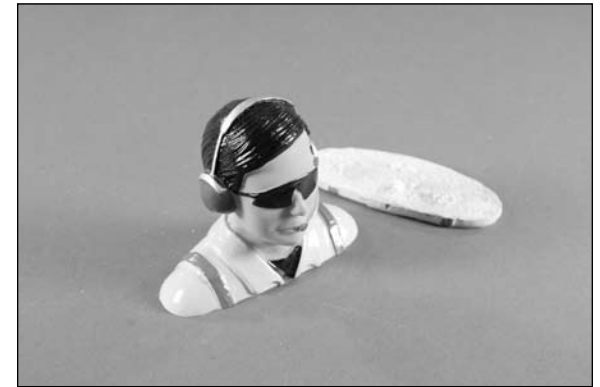

Step 4

Use 30-minute epoxy to glue the pilot into the cockpit. The pilot should be roughly 3¹/₂ inches to 3³/₄ inches (89mm to 95mm) back from the front edge of the cockpit opening.

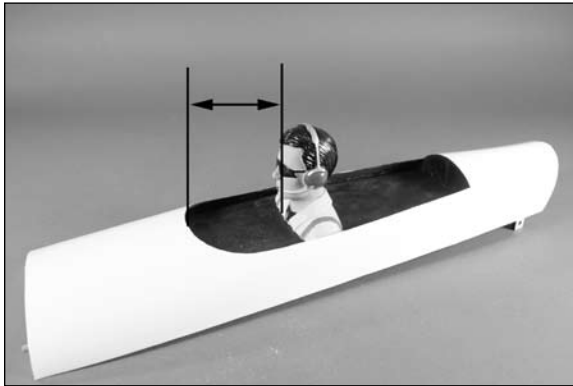

Step 5

Use canopy glue to glue the canopy to the canopy hatch. Use low-tack tape to keep the canopy in position on the hatch until the glue fully cures.

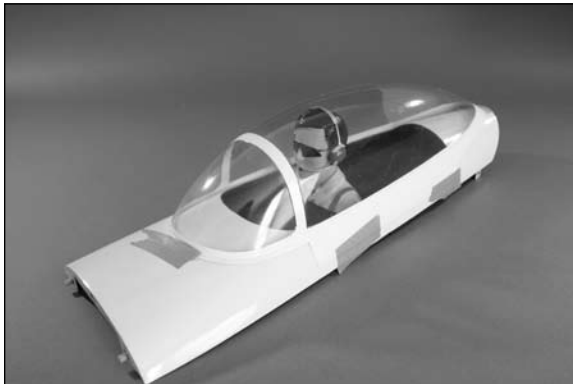

Section 11:

Aileron and Flap Servo Installation

Required Parts

- | | |
|-------------------------------------|-------------------------|
| Wing panel (right and left) | Servo with hardware (4) |
| Heatshrink | Clevis (4) |
| Pushrod keeper (4) | |
| Servo mounting block (8) | |
| Pushrod wire, 7-inch (178mm) (4) | |
| 2mm x 10mm sheet metal screw (16) | |
| Servo extension, 6-inch (152mm) (2) | |

Tools and Adhesives

- | | |
|---|-----------------|
| Hobby knife with #11 blade | Side cutter |
| Ruler | Pencil |
| Medium grit sandpaper | Drill |
| Pin drill | 30-minute epoxy |
| Mixing cup | Mixing stick |
| Epoxy brush | Thin CA |
| Phillips screwdriver: #1 | String |
| T-pin | Low-tack tape |
| Scissors | Ruler |
| Rotary tool with cutoff wheel | Clamps |
| Drill bit: 1/16-inch (1.5mm), 5/64-inch (2mm) | |

Step 1

Remove the servo cover for the aileron from the wing panel. Note the location of the servo horn exit on the cover and how it aligns with the control horn.

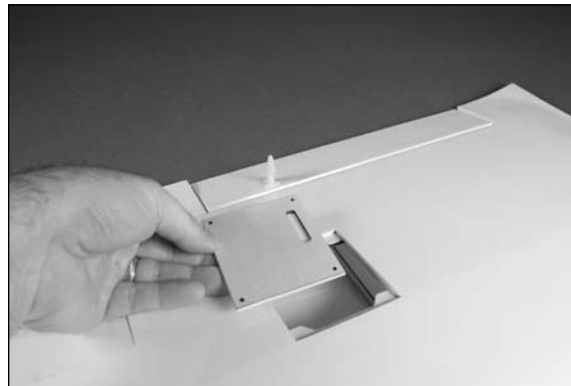

Step 2

Use a hobby knife and #11 blade to remove the covering from the cover so the servo horn can exit.

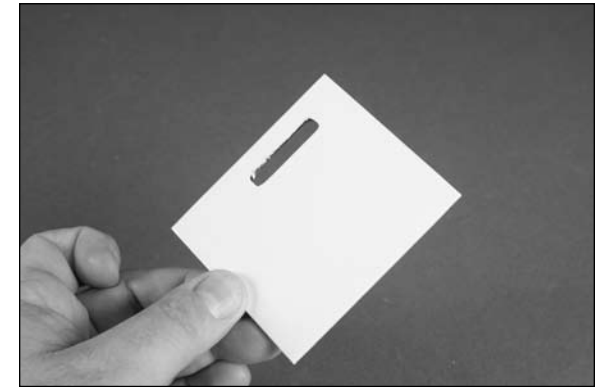

Step 3

Prepare a 180 servo horn by removing one of the arms from the horn as show. Use a pin drill and 5/64-inch (2mm) drill bit to enlarge the outer hole that is 9/16-inch (15mm) from the center of the arm.



□□□□ **Step 4**

Install the rubber grommets and brass eyelets in the servo according to the instructions provided with your servo or radio instruction manual. Use the radio system to center the aileron servo. After removing the stock servo arm, install the 180 arm that was prepared in the previous step. Note the direction of the arm in relationship to the servo and servo cover.

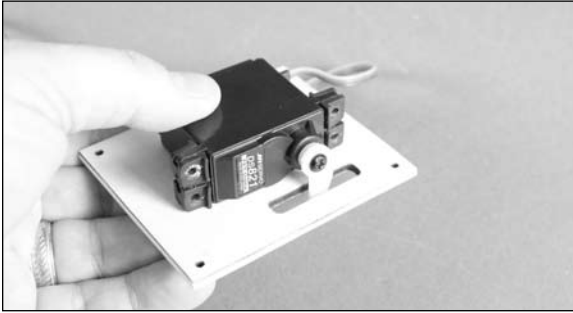

□□□□ **Step 5**

With the arm centered in the opening in the servo cover, use a pencil to transfer the location of the servo on the cover.

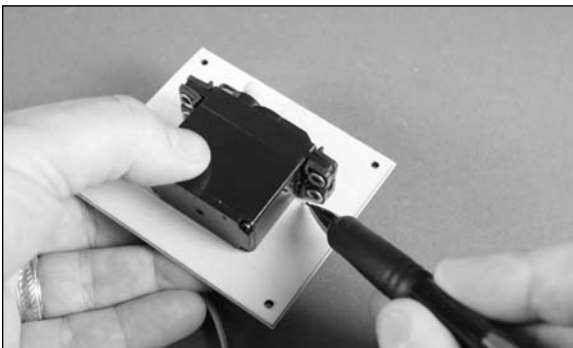
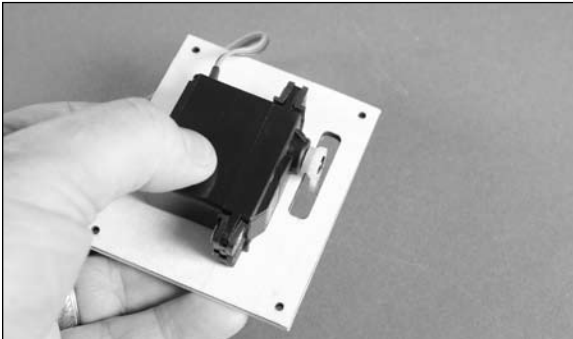

□□□□ **Step 6**

Use medium grit sandpaper to roughen the end grain of the servo mounting block where it will fit against the servo cover. This will improve surface for the epoxy to bond to in the following step. Make sure to sand the end grain of the blocks.

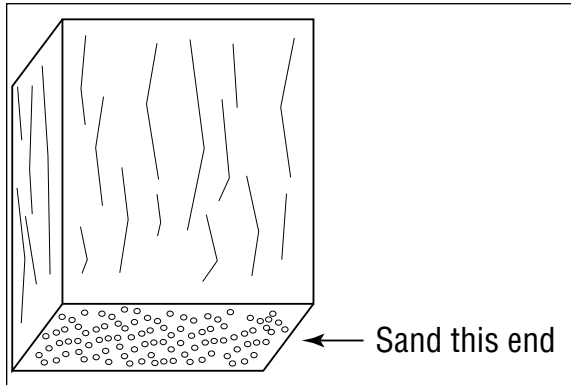
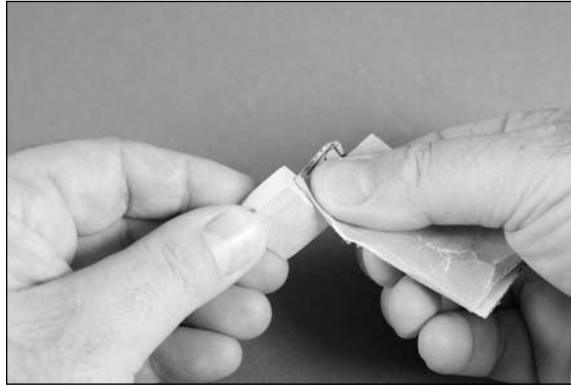

□□□□ **Step 7**

Use 30-minute epoxy to glue the blocks to the servo cover at the marks made earlier. Use clamps or tape to keep the block tight against the servo cover until the epoxy fully cures.

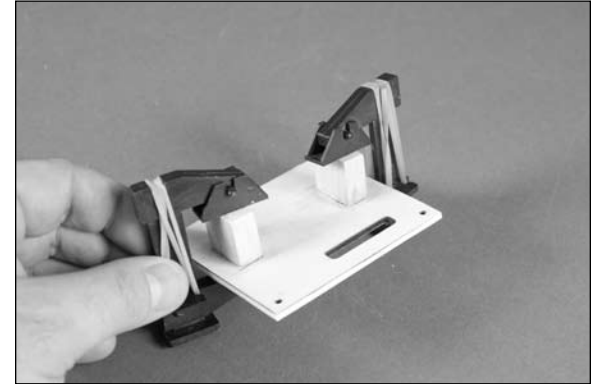

□□□□ **Step 8**

Position the servo on the servo cover. Leave a small gap of 1/32-inch (1mm) between the servo and cover so vibration won't be transferred through the cover and into the servo. Use a pencil to mark the locations for the four servo mounting screws.

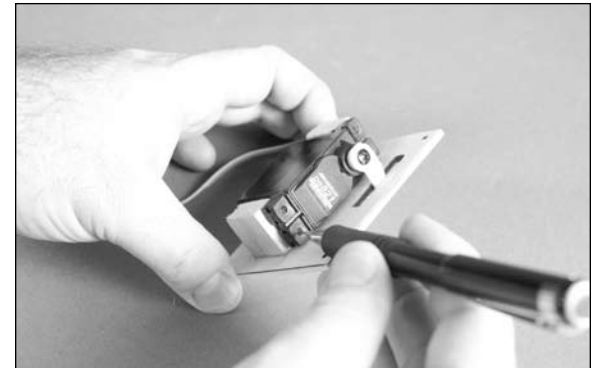

□□□□ Step 9

Use a drill and 1/16-inch (1.5mm) drill bit to drill the four holes on the blocks for the servo mounting screws. Place 2 to 3 drops of thin CA in each hole to harden the surrounding wood.

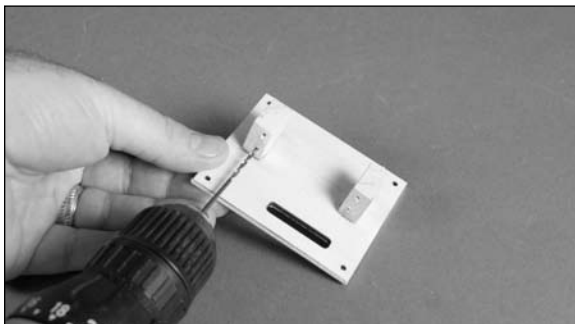

□□□□ Step 10

Use a #1 Phillips screwdriver and the screws provided with the servo to secure the servo to the mounting blocks.

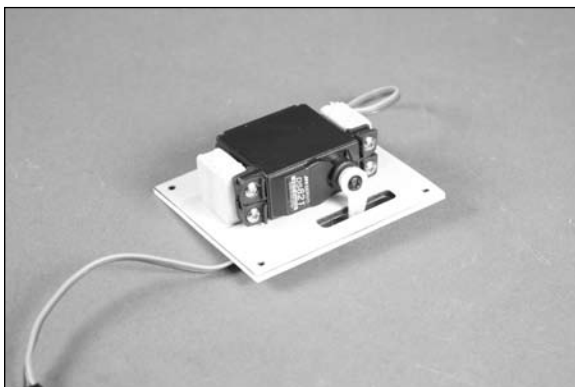

□□ Step 11

Secure a 6-inch (152mm) servo extension to the aileron servo lead. Use string or a commercially available connector to keep the connection from unplugging accidentally inside the wing.

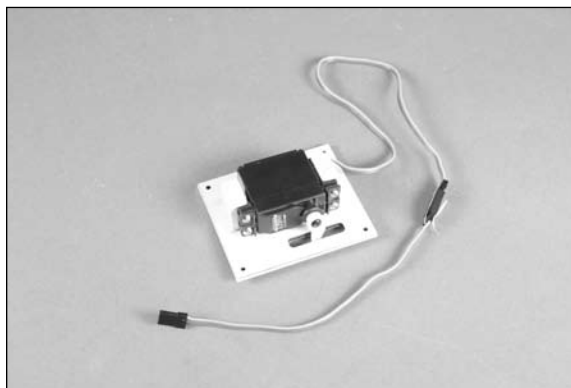

Note: The flap servos will not require the installation of the servo extension. Skip Step 11 when preparing the flap servos.

□□ Step 12

Remove the tape that secures the string inside the opening for the aileron servo. Tie the string around the end of the extension. Remove the cover for the flap servo. Note the location of the servo horn exit on the cover and how it aligns with the control horn.

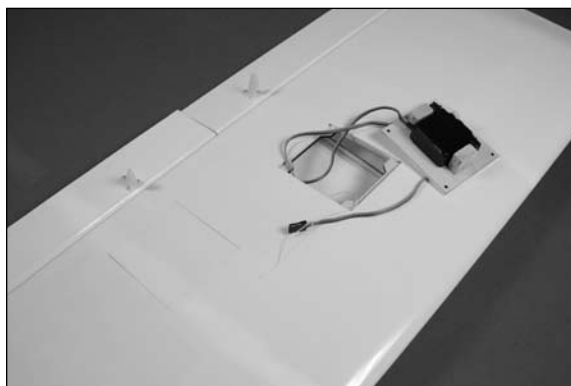

□□ Step 13

Use the string to pull the aileron servo extension into the opening for the flap servo.

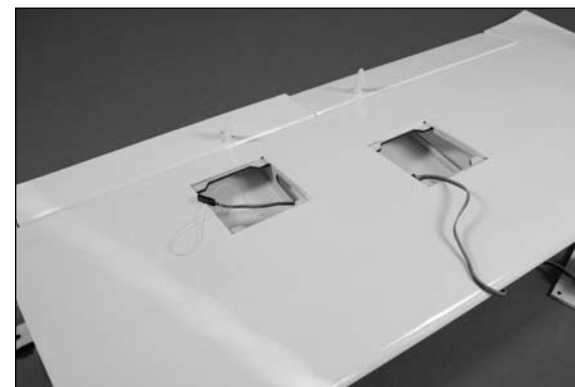

□□□□ **Step 14**

Use a T-pin to poke a hole through the covering in the servo cover to locate the positions for the servo cover screws.



□□□□ **Step 15**

Use a drill and 1/16-inch (1.5mm) drill bit to drill the four locations for the servo cover screws. Use care not to accidentally drill through and damage the covering on the top of the wing.

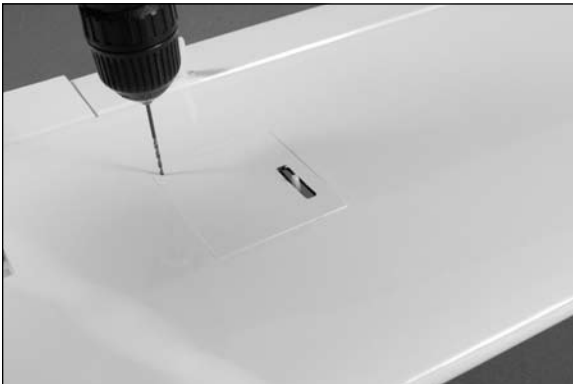

□□□□ **Step 16**

Apply 2 to 3 drops of thin CA into each of the holes to harden the surrounding wood.

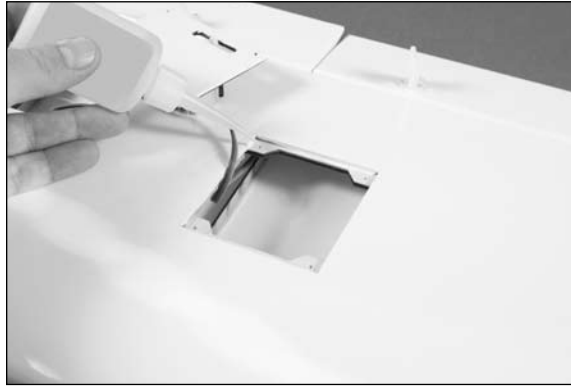

□□□□ **Step 17**

Use four 2mm x 10mm sheet metal screws and a #1 Phillips screwdriver to secure the servo cover to the wing.



□□ **Step 18**

Use low-tack tape to tape the flap and aileron in the center position. This will make installing the linkages easier as the control surfaces won't be moving while marking the linkage wires.



□□□□ **Step 19**

Prepare one of the 7-inch (178mm) pushrod wires by cutting a 1/4-inch (6mm) piece of heat shrink tubing and sliding it on a clevis, then threading the clevis 10-turns on the threaded end of the pushrod wire.

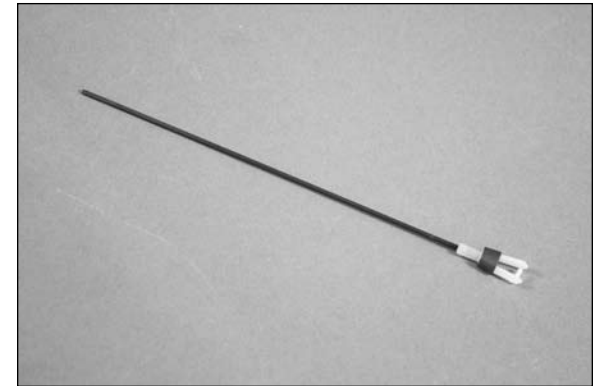

Note: The heat shrink on the clevises will be tightened after the control throws have been set.

□□□□ **Step 20**

Connect the clevis to the middle hole of the aileron control horn. After double-checking that the aileron servo is centered using the radio, use a felt-tipped pen to mark the pushrod where it crosses the center hole of the servo horn.

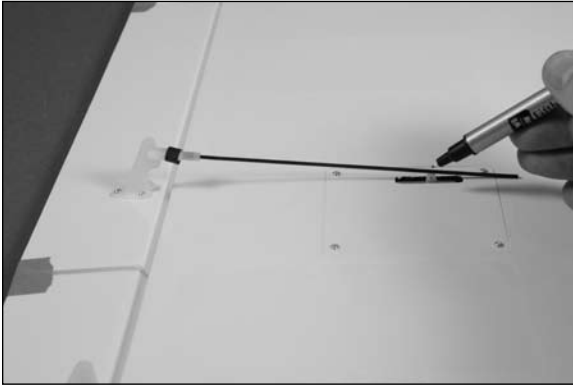

□□□□ **Step 21**

Make a 90-degree bend in the pushrod made in the previous step. Use a rotary tool and cutoff wheel to trim the pushrod wire 3/8-inch (10mm) from the bend as shown.

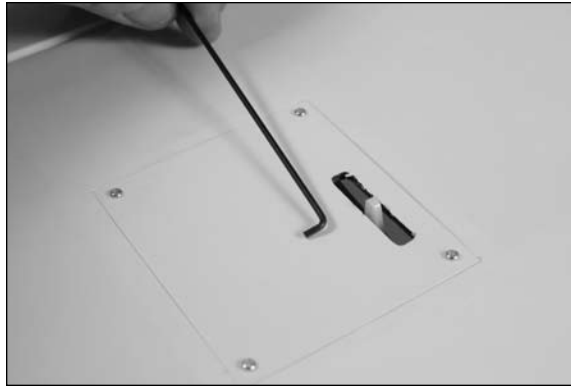
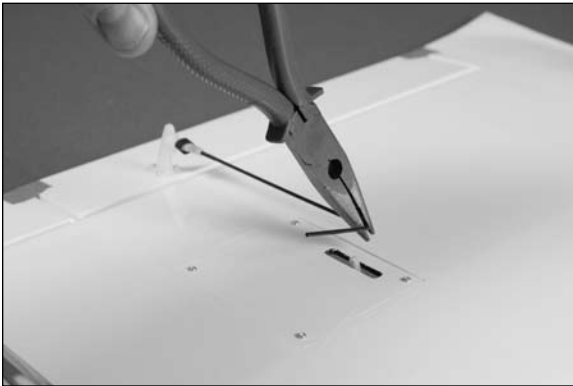

□□□□ **Step 22**

Insert the pushrod wire through the outer hole of the aileron servo horn. Use a pushrod keeper to secure the pushrod to the aileron servo horn.

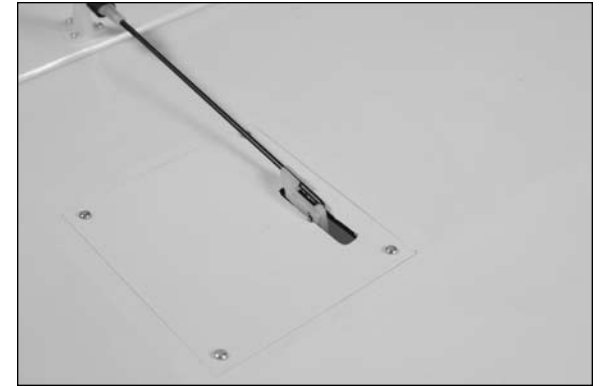
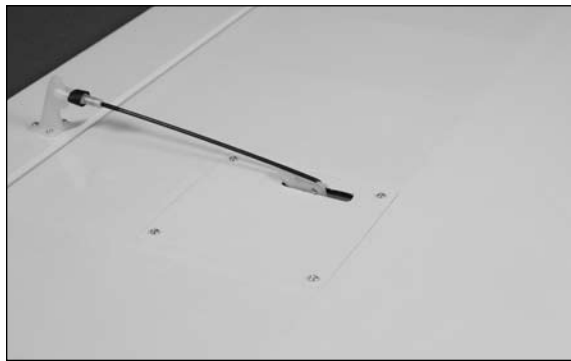
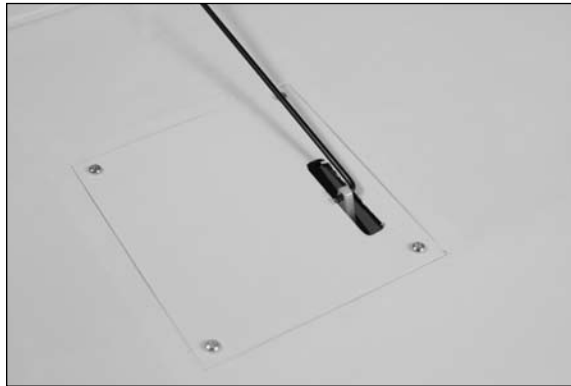

□□ **Step 23**

Follow Steps 2 through 22 to install the flap servo. The flap servo will not require an extension as described in Step 12. In addition, when pulling the extension through the wing in Step 13, you will be pulling both the aileron and flap leads to the center of the wing as shown.

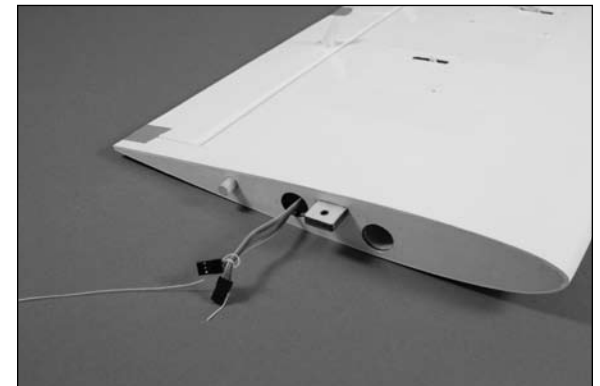
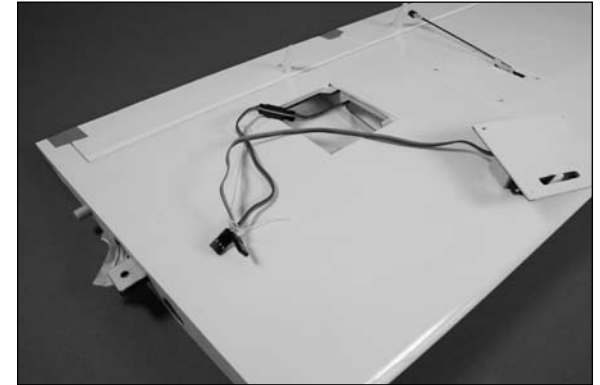

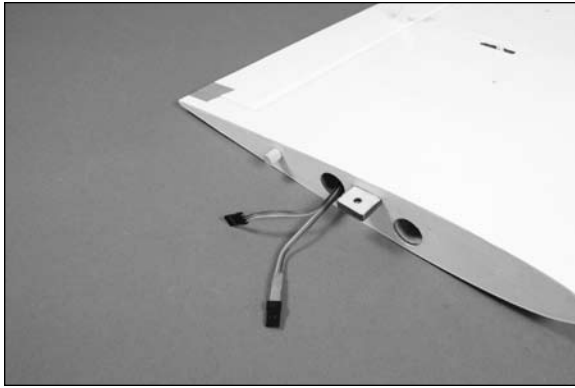

Important: Make sure the flap servo is in the “UP” position before measuring and marking the flap linkage.

Hint: A small piece of blue tape on the flap servo leads will help in identifying the leads when the wing is being installed on the fuselage.

Step 24

Repeat Steps 1 through 23 to install the aileron and flap servos in the opposite wing panel.

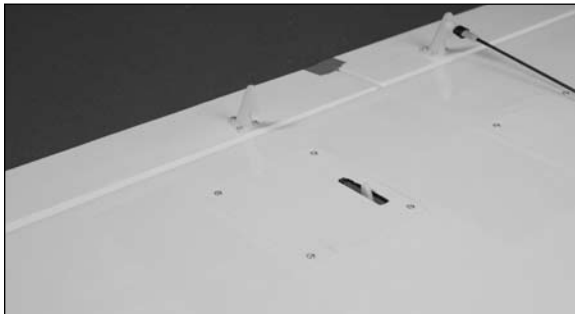
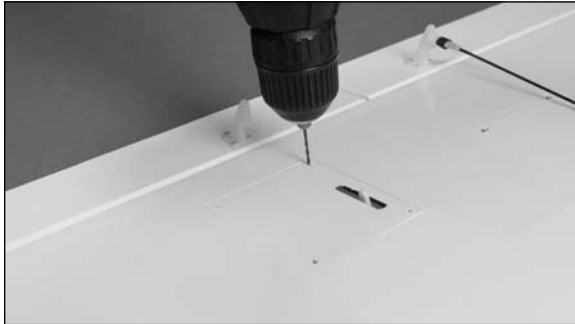

Section 12: Wing and Canopy Hatch installation

Required Parts

Wing panel (right and left)	Fuselage assembly
Aluminum wing tube	Canopy hatch assembly
3mm washer (2)	3mm washer (4)
3mm x 15mm socket head screw (2)	
3mm x 20mm socket head screw (2)	

Tools and Adhesives

Hex wrench or ball driver: 2.5mm
Hobby knife with #11 blade

Step 1

Use a hobby knife with a #11 blade to remove the covering on both sides of the fuselage to access the wing tube, wing mounting tab, wing anti-rotation pin and servo extension openings. Remove the covering on the bottom of the fuselage as well to access the holes for the wing mounting screws.



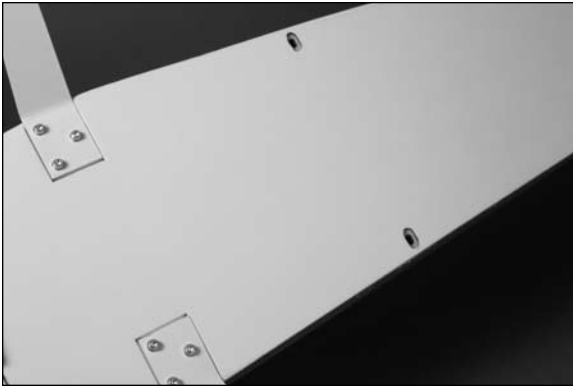

□ □ Step 2

Apply thin Ca to the exposed wood to prevent fuel from soaking into the wood.



□ □ Step 3

Pass the aileron and flap servo leads from the receiver out through the servo lead holes in the fuselage. Wrap a piece of low-tack tape around the flap leads so they can easily be identified when installing the wing panels.

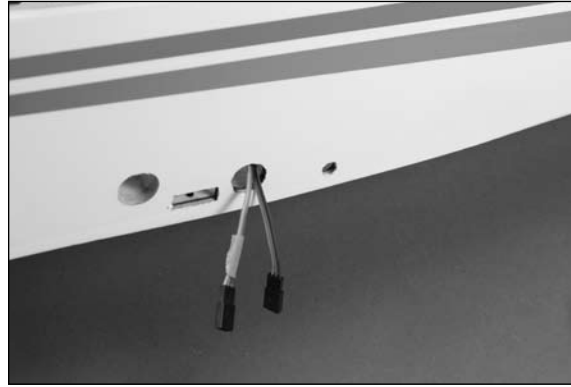

□ □ Step 4

Insert the wing tube into one of the wing panels. The tube should slide in easily and not require any force to insert.



□ □ Step 5

Slide the wing tube and wing panel into the wing tube in the fuselage. Plug the leads for the aileron and flap servos together at this time.



□ □ Step 6

Slide the wing panel tight against the fuselage. Make sure the servo leads are inside the wing or fuselage and not keeping the wing panel from fitting tight against the wing. Use a 2.5mm ball driver or hex wrench to tighten the 3mm x 20mm socket head screws and 3mm washer that secures the wing to the fuselage.



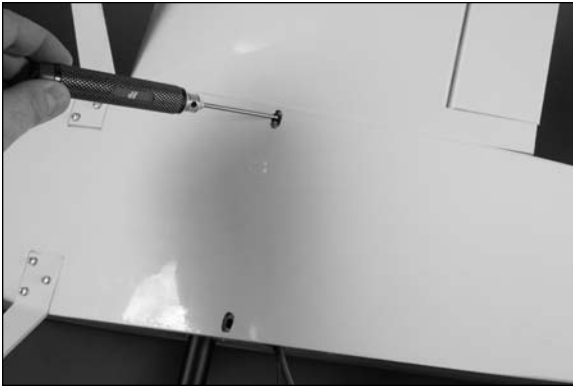

Step 7

Repeat Steps 3 through 6 to secure the remaining wing panel to the fuselage.

Step 8

Place the canopy hatch on the fuselage.



Step 9

Use two 3mm x 15mm socket head screws and two 3mm washers to secure the hatch to the fuselage. You will need to use a 2.5mm ball driver or hex wrench to tighten the screws..



Section 13: Center of Gravity

An important part of preparing the aircraft for flight is properly balancing the model.

Caution: Do not inadvertently skip this step!

The recommended Center of Gravity (CG) location for the your model is 3½-inch (90mm) back, or 25% of the chord, from the leading edge of the wing. Mark the location for the Center of Gravity on the top of the wing next to the fuselage as shown.

When balancing your model, support the plane inverted at the marks made on the top of the wing with your fingers or a commercially available balancing stand. This is the correct balance point for your model. You might find you may be required to add a small amount of weight to either the front or back of the fuselage to achieve the correct balance.

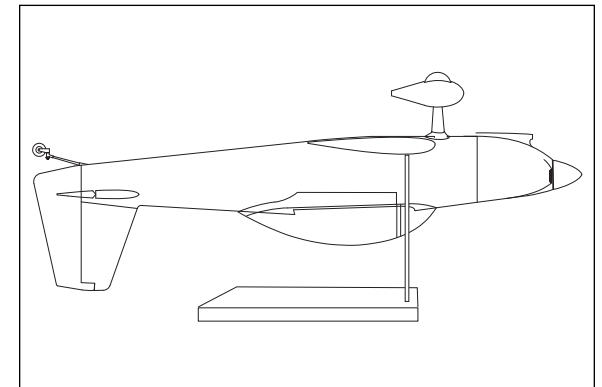
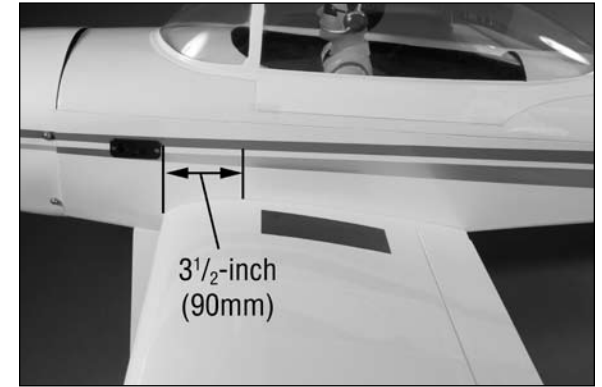

After the first flights, the CG position can be adjusted for your personal preference.

Section 14: Control Throws

Step 1

Check the battery voltage on both the transmitter and the receiver battery packs. Do not fly below 4.3V on the transmitter if you are using a Spektrum transmitter that uses 4-cells to power the transmitter. Do not fly below 9.5V on the transmitter if you are using a JR or Spektrum transmitter that uses 8-cells to power the transmitter. Do not fly if the receiver pack is at or below 4.7V. To do so may crash your aircraft.

Step 2

Check the movement of the elevator with the radio system. Moving the elevator stick toward the bottom of the transmitter will make the airplane elevator move up.

Step 3

Check the movement of the ailerons with the radio system. Moving the aileron stick right will make the right aileron move up and the left aileron move down.

Step 4

Use a ruler to adjust the throw of the elevator, ailerons and rudder.

Aileron High Rate

Up	7/8-inch	22mm
Down	1/2-inch	13mm

Aileron Low Rate

Up	11/16-inch	17mm
Down	3/8-inch	10mm

Elevator High Rate

Up	1 ⁵ / ₁₆ -inch	33mm
Down	7/8-inch	22mm

Elevator Low Rate

Up	7/8-inch	22mm
Down	9/16-inch	14mm

Rudder High Rate

Left	2-inch	51mm
Right	2-inch	51mm

Rudder Low Rate

Left	1 ³ / ₄ -inch	44mm
Right	1 ³ / ₄ -inch	44mm

Flaps

Up	Align with wing trailing edge	
Mid	1/2-inch	13mm
Down	1 ¹ / ₄ -inch	30mm

Note: Measurements are taken at the inner or widest point on the control surface.

These are general guidelines measured from our own flight tests. You can experiment with higher rates to match your preferred style of flying.

Note: Travel Adjust, Sub Trim and Dual Rates are not listed and should be adjusted according to each individual model and preference.

Once all control throws are set, shrink the tubing at all the clevises to keep them from opening up during flight. Use caution not to damage the covering around the control horn by applying too much heat.

Section 15: Flight Preparations

Flight preparations must be checked each time you travel to the flying field. Because your model will encounter a variety of situations, it is best to keep an eye on the various components of your model to keep it in the best flying condition.

Checking the Frequency

When using a Spektrum radio system, follow the guidelines for use of DSM radio systems at your particular field.

Checking the Controls

Before starting your engine, check to make sure the controls are operating in the correct directions and the linkages and surfaces are not binding anywhere. Also look at the clevises and clevis retainers to make sure they are secure and will not come loose or fail in flight.

Fueling your Model

Fill the fuel tank with the proper fuel. Fill the tank by connecting the fuel pump to the line going to the needle valve or to the fuel dot on the side of the cowling. Disconnect the fuel line attached to the pressure fitting of the muffler; your tank is full when fuel begins to run out of the pressure line. Reconnect the fuel lines to the needle valve assembly or insert the plug into the fuel dot and connect the line to the muffler.

Note: It is very important to reconnect the lines to the correct place. If they are reconnected incorrectly, the engine will not run properly.

Section 16: Maintaining Your Model

The following is a check list that you should follow every time you have completed a flying session with your model. Doing so will keep your aircraft in the best flying condition.

Clean Up

After a long flying session with your model, you will want to clean it up before loading it into your vehicle to head home. Use a cleaner such as Windex or 409 and a paper towel to wipe down the exterior of your plane, removing the fuel residue. Remember, a clean plane will last longer since the fuel won't be allowed to soak into any exposed wood.

Checking the Propeller

Check to make sure the propeller is tightly secured to the engine. If not, remove the spinner and use a crescent wrench to tighten it back down. If you have had any not so great landings, you will want to inspect the propeller for any damage. Small nicks and scratches can quickly become fractures, causing the propeller to be unsafe for flight. Always carry a few spare propellers so a damaged propeller can be replaced at the field, increasing your flying time per trip to the field.

Checking the Clevises

Inspect the aileron, elevator and rudder clevises to make sure they are connected and in good working order. If you find a clevis that is showing signs of wear or is broken, replace it with a new clevis. Also check the nylon connectors at the servo for any wear or damage. If they look worn or in bad shape, replace them as well.

Checking the Control Horns

Inspect the control horns to make sure they have not crushed the wood of the control surface. If so, remove the control horn screws to remove the control horn. Place 2–3 drops of thin CA into each of the screw holes. In addition, use a T-pin to poke small holes in the covering in the area where the control horn mounts, then saturate the area with thin CA. This will harden the wood and give the control horns a solid surface to be mounted to.

Checking the Wheel Collars

Check the setscrews on the wheel collars for the main and tail wheel to make sure they are not loose. Use a 1.5mm hex wrench to tighten the setscrews. It is suggested if they loosen frequently to remove them, apply threadlock to the setscrews, then secure the wheel collars back into position. The threadlock and hex wrench are included in the kit for this purpose.

Check the Muffler Bolts

Use a 2.5mm hex wrench (Evolution 2-stroke) or box wrench (Saito 4-stroke) to make sure the hardware holding the muffler onto the engine is tight and has not vibrated loose during flight.

Check the Engine Mount Bolts

Remove the spinner and propeller from the engine. Remove the exhaust stacks from the fuselage, and then remove the cowling from the fuselage. Remove the muffler from the engine, and then use a Phillips screwdriver to make sure the four bolts securing the engine to the mount are tight.

Section 17: Safety Do's and Don'ts for Pilots

- Ensure that your batteries have been properly charged prior to your initial flight.
- Keep track of the time the system is turned on so you will know how long you can safely operate your system.
- Perform a ground range check prior to the initial flight of the day. See the "Daily Flight Checks Section" for information.
- Check all control surfaces prior to each takeoff.
- Do not fly your model near spectators, parking areas or any other area that could result in injury to people or damage of property.
- Do not fly during adverse weather conditions. Poor visibility can cause disorientation and loss of control of your aircraft. Strong winds can cause similar problems.
- Do not point the transmitter antenna directly toward the model. The radiation pattern from the tip of the antenna is inherently low.
- Do not take chances. If at any time during flight you observe any erratic or abnormal operation, land immediately and do not resume flight until the cause of the problem has been ascertained and corrected. Safety can never be taken lightly.

Dual Rate Recommendations

- We recommend that the rudder dual rate be set to Low for takeoff to help minimize overcorrection during the takeoff roll.
- We recommend the rudder dual rate be set to High for landing to help maintain heading as the model transitions from flying speed to taxi speeds.
- Elevator and Aileron dual rates should be adjusted for personal feel and also if there is any unusual wind conditions.

Section 18: Daily Flight Checks

Step 1

Check the battery voltage on both the transmitter and the receiver battery packs. Do not fly below 4.3V on the transmitter if you are using a Spektrum transmitter that uses 4-cells to power the transmitter. Do not fly below 9.5V on the transmitter if you are using a JR or Spektrum transmitter that uses 8-cells to power the transmitter. Do not fly if the receiver pack is at or below 4.7V. To do so may crash your aircraft.

Note: When you check these batteries, ensure that you have the polarities correct on your expanded scale voltmeter.

Step 2

Check all hardware (linkages, screws, nuts, and bolts) prior to each day's flight. Be sure that binding does not occur and that all parts are properly secured.

Step 3

Ensure that all surfaces are moving in the proper manner.

Step 4

Perform a ground range check before each day's flying session.

Step 5

Prior to starting your aircraft, turn off your transmitter, then turn it back on. Do this each time you start your aircraft. If any critical switches are on without your knowledge, the transmitter alarm will warn you at this time.

Step 6

Check that all trim levers are in the proper location.

Step 7

All servo pigtailed and switch harness plugs should be secured in the receiver. Make sure that the switch harness moves freely in both directions.

Section 19: Glossary of Terms

- **Ailerons:** Each side of this airplane has a hinged control surface (aileron), located on the trailing edge of the wing. Move the aileron stick on the transmitter left, the left aileron moves up and the right aileron moves down. Moving the left aileron up causes more drag and less lift, causing the left wing to drop down. When the right aileron moves down, more lift is created, causing the right wing to rise. This interaction causes the airplane to turn or roll to the left. Perform the opposite actions, and the airplane will roll to the right..
- **Clevis:** The clevis connects the wire end of the pushrod to the control horn of the control surface. A small clip, the clevis has fine threads so that you can adjust the length of the pushrod.
- **Control Horn:** This arm connects the control surface to the clevis and pushrod.
- **Dihedral:** The degree of angle (V-shaped bend) at which the wings intersect the fuselage is called dihedral. More dihedral gives an airplane more aerodynamic stability. Some sailplanes and trainer planes with large dihedral dispense with ailerons and use only the rudder to control the roll and yaw.
- **Elevator:** The hinged control surface on the back of the stabilizer that moves to control the airplane's pitch axis. Pulling the transmitter's control stick toward the bottom of the transmitter moves the elevator upward, and the airplane begins to climb. Push the control stick forward, and the airplane begins to dive.
- **Fuselage:** The main body of an airplane.
- **Hinge:** Flexible pieces used to connect the control surface to the flying surface. All hinges must be glued properly and securely to prevent the airplane from crashing.
- **Horizontal Stabilizer:** The horizontal flying surface of the tail gives the airplane stability while in flight.
- **Leading Edge:** The front of a flying surface.
- **Main Landing Gear:** The wheel and gear assembly the airplane uses to land. It is attached to the bottom of the fuselage.

- **Pitch Axis:** The horizontal plane on which the airplane's nose is raised or lowered. By moving the elevator, you can raise the airplane's nose above the pitch axis (climb) or lower it below the pitch axis (dive).
- **Pushrod:** The rigid mechanism that transfers movement from the servo to the control surface.
- **Roll Axis:** The horizontal plane on which the airplane's wings are raised or lowered. By adjusting the ailerons, you can drop a wing tip below the roll axis and cause the airplane to bank or roll.
- **Rudder:** The hinged control surface on the vertical stabilizer that controls the airplane's yaw. Moving the rudder to the left causes the airplane to yaw left; moving the rudder to the right causes it to yaw right.
- **Servo:** The servo transforms your transmitter commands into physical adjustments of the airplane.
- **Servo Output Arm:** A removable arm or wheel that connects the servo to the pushrod (also called servo horn).
- **Spinner:** Term describing the nose cone that covers the propeller hub.
- **Threadlock:** A liquid that solidifies; used to prevent screws from loosening due to vibration.
- **Torque Rods:** Inserted into the ailerons, these rigid wire rods run along the wing's trailing edge, then bend downward and connect to the pushrod.
- **Vertical Stabilizer:** The vertical flying surface of the tail gives an airplane stability while in flight.
- **Wheel Collar:** The round retaining piece that anchors wheels in place on the wheel axle.
- **Wing:** The lifting surface of an airplane.
- **Yaw Axis:** The vertical plane through which the airplane's nose rotates as it yaws to the left or to the right. The rudder controls the yaw axis.

Section 20: Safety, Precautions and Warnings

As the user of this product, you are solely responsible for operating it in a manner that does not endanger yourself and others or result in damage to the product or the property of others.

Carefully follow the directions and warnings for this and any optional support equipment (chargers, rechargeable battery packs, etc.) that you use.

This model is controlled by a radio signal that is subject to interference from many sources outside your control. This interference can cause momentary loss of control so it is necessary to always keep a safe distance in all directions around your model, as this margin will help to avoid collisions or injury.

- Always operate your model in an open area away from cars, traffic or people.
- Avoid operating your model in the street where injury or damage can occur.
- Never operate the model out into the street or populated areas for any reason.
- Never operate your model with low transmitter batteries.
- Carefully follow the directions and warnings for this and any optional support equipment (chargers, rechargeable battery packs, etc.) that you use.
- Keep all chemicals, small parts and anything electrical out of the reach of children.
- Moisture causes damage to electronics. Avoid water exposure to all equipment not specifically designed and protected for this purpose.

Section 21: Warranty Information

WARRANTY PERIOD

Exclusive Warranty- Horizon Hobby, Inc., (Horizon) warranties that the Products purchased (the "Product") will be free from defects in materials and workmanship at the date of purchase by the Purchaser.

LIMITED WARRANTY

(a) This warranty is limited to the original Purchaser ("Purchaser") and is not transferable. REPAIR OR REPLACEMENT AS PROVIDED UNDER THIS WARRANTY IS THE EXCLUSIVE REMEDY OF THE PURCHASER. This warranty covers only those Products purchased from an authorized Horizon dealer. Third party transactions are not covered by this warranty. Proof of purchase is required for warranty claims. Further, Horizon reserves the right to change or modify this warranty without notice and disclaims all other warranties, express or implied.

(b) Limitations- HORIZON MAKES NO WARRANTY OR REPRESENTATION, EXPRESS OR IMPLIED, ABOUT NON-INFRINGEMENT, MERCHANTABILITY OR FITNESS FOR A PARTICULAR PURPOSE OF THE PRODUCT. THE PURCHASER ACKNOWLEDGES THAT THEY ALONE HAVE DETERMINED THAT THE PRODUCT WILL SUITABLY MEET THE REQUIREMENTS OF THE PURCHASER'S INTENDED USE.

(c) Purchaser Remedy- Horizon's sole obligation hereunder shall be that Horizon will, at its option, (i) repair or (ii) replace, any Product determined by Horizon to be defective. In the event of a defect, these are the Purchaser's exclusive remedies. Horizon reserves the right to inspect any and all equipment involved in a warranty claim. Repair or replacement decisions are at the sole discretion of Horizon. This warranty does not cover cosmetic damage or damage due to acts of God, accident, misuse, abuse, negligence, commercial use, or modification of or to any part of the Product. This warranty does not cover damage due to improper installation, operation, maintenance, or attempted repair by anyone other than Horizon. Return of any goods by Purchaser must be approved in writing by Horizon before shipment.

DAMAGE LIMITS

HORIZON SHALL NOT BE LIABLE FOR SPECIAL, INDIRECT OR CONSEQUENTIAL DAMAGES, LOSS OF PROFITS OR PRODUCTION OR COMMERCIAL LOSS IN ANY WAY CONNECTED WITH THE PRODUCT, WHETHER SUCH CLAIM IS BASED IN CONTRACT, WARRANTY, NEGLIGENCE, OR STRICT LIABILITY. Further, in no event shall the liability of Horizon exceed the individual price of the Product on which liability is asserted. As Horizon has no control over use, setup, final assembly, modification or misuse, no liability shall be assumed nor accepted for any resulting damage or injury. By the act of use, setup or assembly, the user accepts all resulting liability.

If you as the Purchaser or user are not prepared to accept the liability associated with the use of this Product, you are advised to return this Product immediately in new and unused condition to the place of purchase.

Law: These Terms are governed by Illinois law (without regard to conflict of law principals).

SAFETY PRECAUTIONS

This is a sophisticated hobby Product and not a toy. It must be operated with caution and common sense and requires some basic mechanical ability. Failure to operate this Product in a safe and responsible manner could result in injury or damage to the Product or other property. This Product is not intended for use by children without direct adult supervision. The Product manual contains instructions for safety, operation and maintenance. It is essential to read and follow all the instructions and warnings in the manual, prior to assembly, setup or use, in order to operate correctly and avoid damage or injury.

QUESTIONS, ASSISTANCE, AND REPAIRS

Your local hobby store and/or place of purchase cannot provide warranty support or repair. Once assembly, setup or use of the Product has been started, you must contact Horizon directly. This will enable Horizon to better answer your questions and service you in the event that you may need any assistance. For questions or assistance, please direct your email to productsupport@horizonhobby.com, or call 877.504.0233 toll free to speak to a service technician.

INSPECTION OR REPAIRS

If this Product needs to be inspected or repaired, please call for a Return Merchandise Authorization (RMA). Pack the Product securely using a shipping carton. Please note that original boxes may be included, but are not designed to withstand the rigors of shipping without additional protection. Ship via a carrier that provides tracking and insurance for lost or damaged parcels, as Horizon is not responsible for merchandise until it arrives and is accepted at our facility. A Service Repair Request is available at www.horizonhobby.com on the "Support" tab. If you do not have internet access, please include a letter with your complete name, street address, email address and phone number where you can be reached during business days, your RMA number, a list of the included items, method of payment for any non-warranty expenses and a brief summary of the problem. Your original sales receipt must also be included for warranty consideration. Be sure your name, address, and RMA number are clearly written on the outside of the shipping carton.

WARRANTY INSPECTION AND REPAIRS

To receive warranty service, you must include your original sales receipt verifying the proof-of-purchase date. Provided warranty conditions have been met, your Product will be repaired or replaced free of charge. Repair or replacement decisions are at the sole discretion of Horizon Hobby.

NON-WARRANTY REPAIRS

Should your repair not be covered by warranty the repair will be completed and payment will be required without notification or estimate of the expense unless the expense exceeds 50% of the retail purchase cost. By submitting the item for repair you are agreeing to payment of the repair without notification. Repair estimates are available upon request. You must include this request with your repair. Non-warranty repair estimates will be billed a minimum of 1/2 hour of labor. In addition you will be billed for return freight. Please advise us of your preferred method of payment. Horizon accepts money orders and cashiers checks, as well as Visa, MasterCard, American Express, and Discover cards. If you choose to pay by credit card, please include your credit card number and expiration date. Any repair left unpaid or unclaimed after 90 days will be considered abandoned and will be disposed of accordingly. Please note: non-warranty repair is only available on electronics and model engines.

United States:

Electronics and engines requiring inspection or repair should be shipped to the following address:

Horizon Service Center
4105 Fieldstone Road
Champaign, Illinois 61822

All other Products requiring warranty inspection or repair should be shipped to the following address:

Horizon Product Support
4105 Fieldstone Road
Champaign, Illinois 61822

Please call 877-504-0233 or e-mail us at productsupport@horizonhobby.com with any questions or concerns regarding this product or warranty.

United Kingdom:

Electronics and engines requiring inspection or repair should be shipped to the following address:

Horizon Hobby UK
Units 1-4 Ployters Rd
Staple Tye
Harlow, Essex
CM18 7NS
United Kingdom

Please call +44 (0) 1279 641 097 or e-mail us at sales@horizonhobby.co.uk with any questions or concerns regarding this product or warranty.

Germany:

Electronics and engines requiring inspection or repair should be shipped to the following address:

Horizon Technischer Service
Hamburger Strasse 10
25335 Elmshorn
Germany

Please call +49 4121 46199 66 or e-mail us at service@horizonhobby.de with any questions or concerns regarding this product or warranty.

Instructions for Disposal of WEEE by Users in the European Union

This product must not be disposed of with other waste. Instead, it is the user's responsibility to dispose of their waste equipment by handing it over to a designated collection point for the recycling of waste electrical and electronic equipment. The separate collection and recycling of your waste equipment at the time of disposal will help to conserve natural resources and ensure that it is recycled in a manner that protects human health and the environment. For more information about where you can drop off your waste equipment for recycling, please contact your local city office, your household waste disposal service or where you purchased the product.



Building Notes

Flying Notes

2009 Official Academy of Model Aeronautics Safety Code

GENERAL

1. A model aircraft shall be defined as a non-human-carrying device capable of sustained flight in the atmosphere. It shall not exceed limitations established in this code and is intended to be used exclusively for recreational or competition activity.
2. The maximum takeoff weight of a model aircraft, including fuel, is 55 pounds, except for those flown under the AMA Experimental Aircraft Rules.
3. I will abide by this Safety Code and all rules established for the flying site I use. I will not willfully fly my model aircraft in a reckless and/or dangerous manner.
4. I will not fly my model aircraft in sanctioned events, air shows, or model demonstrations until it has been proven airworthy.
5. I will not fly my model aircraft higher than approximately 400 feet above ground level, when within three (3) miles of an airport without notifying the airport operator. I will yield the right-of-way and avoid flying in the proximity of full-scale aircraft, utilizing a spotter when appropriate.
6. I will not fly my model aircraft unless it is identified with my name and address, or AMA number, inside or affixed to the outside of the model aircraft. This does not apply to model aircraft flown indoors.
7. I will not operate model aircraft with metal-blade propellers or with gaseous boosts (other than air), nor will I operate model aircraft with fuels containing tetranitromethane or hydrazine.
8. I will not operate model aircraft carrying pyrotechnic devices which explode burn, or propel a projectile of any kind. Exceptions include Free Flight fuses or devices that burn producing smoke and are securely attached to the model aircraft during flight. Rocket motors up to a G-series size may be used, provided they remain firmly attached to the model aircraft during flight. Model rockets may be flown in accordance with the National Model Rocketry Safety Code; however, they may not be launched from model aircraft. Officially designated AMA Air Show Teams (AST) are authorized to use devices and practices as defined within the Air Show Advisory Committee Document.

9. I will not operate my model aircraft while under the influence of alcohol or within eight (8) hours of having consumed alcohol.
10. I will not operate my model aircraft while using any drug which could adversely affect my ability to safely control my model aircraft.
11. Children under six (6) years old are only allowed on a flightline or in a flight area as a pilot or while under flight instruction.
12. When and where required by rule, helmets must be properly worn and fastened. They must be OSHA, DOT, ANSI, SNELL or NOCSAE approved or comply with comparable standards.

RADIO CONTROL

1. All model flying shall be conducted in a manner to avoid over flight of unprotected people.
2. I will have completed a successful radio equipment ground-range check before the first flight of a new or repaired model aircraft.
3. I will not fly my model aircraft in the presence of spectators until I become a proficient flier, unless I am assisted by an experienced pilot.
4. At all flying sites a line must be established, in front of which all flying takes place. Only personnel associated with flying the model aircraft are allowed at or in front of the line. In the case of airshows demonstrations straight line must be established. An area away from the line must be maintained for spectators. Intentional flying behind the line is prohibited.
5. I will operate my model aircraft using only radio-control frequencies currently allowed by the Federal Communications Commission (FCC). Only individuals properly licensed by the FCC are authorized to operate equipment on Amateur Band frequencies.
6. I will not knowingly operate my model aircraft within three (3) miles of any preexisting flying site without a frequency-management agreement. A frequencymanagement agreement may be an allocation of frequencies for each site, a day-use agreement between sites, or testing which determines that no interference exists. A frequency-management agreement may exist between two or more AMA chartered clubs, AMA clubs and individual AMA members, or individual AMA members. Frequency-management agreements, including an interference test report if the agreement indicates no interference exists, will be signed by all parties and copies provided to AMA Headquarters.

7. With the exception of events flown under official AMA rules, no powered model may be flown outdoors closer Building and Flying Notes: than 25 feet to any individual, except for the pilot and located at the flightline.
8. Under no circumstances may a pilot or other person touch a model aircraft in flight while it is still under power, except to divert it from striking an individual.
9. Radio-controlled night flying is limited to low-performance model aircraft (less than 100 mph). The model aircraft must be equipped with a lighting system which clearly defines the aircraft's attitude and direction at all times.
10. The operator of a radio-controlled model aircraft shall control it during the entire flight, maintaining visual contact without enhancement other than by corrective lenses that are prescribed for the pilot. No model aircraft shall be equipped with devices which allow it to be flown to a selected location which is beyond the visual range of the pilot.

Engine Mounting Template

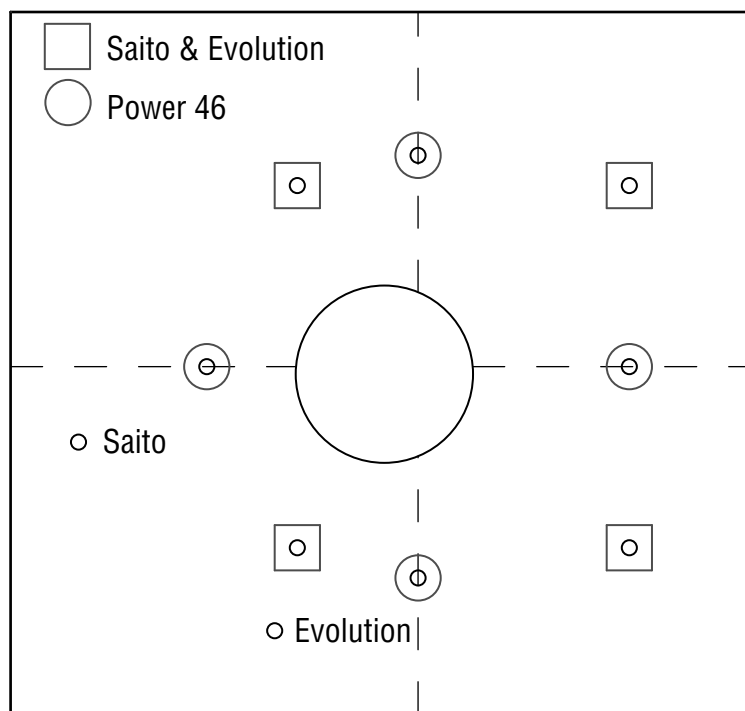

Air Exit Template (EP)

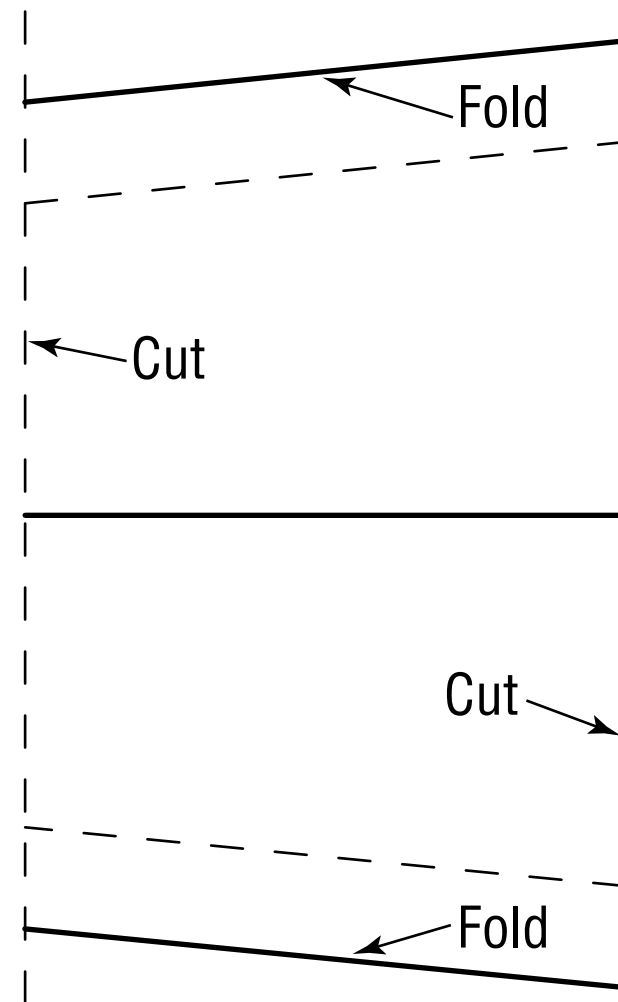



Fly First Class™



© 2009 Horizon Hobby, Inc.
4105 Fieldstone Road
Champaign, Illinois 61822
(877) 504-0233
horizonhobby.com
Hangar9.com