

HANGAR 9®

Fly First Class™

35% Extra 260

ASSEMBLY MANUAL



Specifications

Wingspan..... 105 in (2667mm)
Overall Length..... 98 in (2489mm) with spinner
Wing Area 2003 sq in (129 sq dm)
Flying Weight..... 27–30 lb (12–14 kg)

Engine Size 100–116cc gas
Radio..... 4-channel or more
Servos..... 8 servos
(9 if using two rudder servos instead of 1)
Spinner Size..... 4 1/2-inch
Hardware Included Yes

Table of Contents

Using the Manual	3
Required Tools and Adhesives	3
UltraCote Covering Colors	3
Before Starting Assembly	3
Radio and Power Systems Requirements	4
Recommended JR, JR SPORT and Spektrum Systems	4
Recommended Engine Setup	4
FS One	4
Warranty Period	5
Limited Warranty	5
Damage Limits	5
Safety Precautions	5
Questions, Assistance, and Repairs	6
Inspection or Repairs	6
Warranty Inspection and Repairs	6
Non-Warranty Repairs	6
Safety, Precautions, and Warnings	7
Contents of Kit	7
Aileron Servo Installation	8
Elevator Servo Installation	12
Rudder and Rudder Servo Installation	13
Landing Gear Installation	16
Stabilizer Installation	19
Engine Installation (DA100)	21
Engine Installation (Evolution 116GX)	26
Receiver Installation	30
Pilot and Canopy Installation	32
Radio Setup	33
Control Throws	34
Computer Radio Enhancements	34
Recommended Center of Gravity (CG)	35
Rates and Expos	35
Preflight	36
Range Test Your Radio	37
Instructions for Disposal of WEEE by Users in the European Union	37
2007 Official AMA National Model Aircraft Safety Code	38–39

Using the Manual

This manual is divided into sections to help make assembly easier to understand, and to provide breaks between each major section. In addition, check boxes have been placed next to each step to keep track of each step completed. Steps with a single box (☐) are performed once, while steps with two boxes (☐ ☐) indicate that the step will require repeating, such as for a right or left wing panel, two servos, etc. Remember to take your time and follow the directions.

Required Tools and Adhesives

Tools

- Rotary tool (Dremel)
- Pliers
- T-pins
- Solder
- Solder gun
- Tape
- Phillips screwdriver
- Felt-tipped pen
- Hex wrench: 5/64-inch, 3/32-inch, 7/64-inch, 1/8-inch
- Drill bit: 1/16-inch (1.5mm), 5/64-inch (2mm), 5/32-inch (4mm), 3/16-inch (4.5mm)
- Hobby scissors
- Clamp
- Crimping tool/vice grips
- String
- 1/4-inch (6mm) foam
- Hobby knife
- Drill
- Nut driver: 1/4-inch
- Angle Pro Incidence Meter (HAN192)

Adhesives

- Thin CA (PAAPT08)
- 30-Minute Epoxy (HAN8002)
- CA Remover/Debonder (PAAPT16)
- Medium CA (PAAPT02)
- Formula 560 Canopy Glue (PAAPT56)
- Pacer Z-42 Threadlock (PAAPT42)

UltraCote Covering Colors

- White (HANU870)
- True Red (HANU866)
- Cub Yellow (HANU884)
- Pearl Purple (HANU847)

Before Starting Assembly

Before beginning the assembly of the 35% Extra 260, remove each part from its bag for inspection. Closely inspect the fuselage, wing panels, rudder, and stabilizer for damage. If you find any damaged or missing parts, contact the place of purchase.

If you find any wrinkles in the covering, use a heat gun or sealing iron to remove them. Use caution while working around areas where the colors overlap to prevent separating the colors.



HAN101 – Sealing Iron

**HAN141 – Sealing Iron
Sock**



HAN100 – Heat Gun

HAN150 – Covering Glove

Radio and Power Systems Requirements

- 7-channel computer radio system (minimum) w/receiver
- 24-Inch Servo Lead Extension (JRPA102) (5)
- 36-inch Servo Lead Extension (JRPA103) (3)
- JR 8611A or 8711 Metal Geared high torque servos (7) or equivalent
- Large Servo Arms (JRPA236) (8 pkgs)
- JR Charge Jack Switch (JRPA004) (3)
- Choke Ring (JRPA029) (For throttle servo lead)

Caution: Only metal-gear servos of 180 oz in torque or greater should be used on the control surfaces.

- 2700mAh or larger for receiver (2) (A minimum of 3000mAh is required when using super high-torque servos)
- 1500mAh or larger for ignition (4.8 or 6.0V for DA-100, 3-cell Li-Po for Evolution® 116cc)

The elevator installation will require:

Two servos and mixing through the radio

Or

Two servos and a JR® MatchBox™ (JPA0900)

Recommended JR, JRSPORT and Spektrum Systems

- JR 10X
- JR XP9303
- JR X9303 2.4
- JR XP7202
- Spektrum DX-7



JR XP9303



Spektrum DX7



JR 10X

Recommended Engine Setup

DA-100

- In cowl mufflers
- or
- MTW 75 canisters with headers
 - 27 x 10 propeller

Evolution 116

- In cowl mufflers
- or
- MTW 75 canisters with headers
 - 28 x 10 propeller

FS One

With FS One® you get more than photorealistic fields, gorgeous skies and realistic-looking aircraft. You get incredibly advanced aerodynamic modeling that simulates every possible aspect of real-world flight.



HANS2000

Warranty Period

Exclusive Warranty- Horizon Hobby, Inc., (Horizon) warrants that the Products purchased (the "Product") will be free from defects in materials and workmanship at the date of purchase by the Purchaser.

Limited Warranty

(a) This warranty is limited to the original Purchaser ("Purchaser") and is not transferable. REPAIR OR REPLACEMENT AS PROVIDED UNDER THIS WARRANTY IS THE EXCLUSIVE REMEDY OF THE PURCHASER. This warranty covers only those Products purchased from an authorized Horizon dealer. Third party transactions are not covered by this warranty. Proof of purchase is required for warranty claims. Further, Horizon reserves the right to change or modify this warranty without notice and disclaims all other warranties, express or implied.

(b) Limitations- HORIZON MAKES NO WARRANTY OR REPRESENTATION, EXPRESS OR IMPLIED, ABOUT NON-INFRINGEMENT, MERCHANTABILITY OR FITNESS FOR A PARTICULAR PURPOSE OF THE PRODUCT. THE PURCHASER ACKNOWLEDGES THAT THEY ALONE HAVE DETERMINED THAT THE PRODUCT WILL SUITABLY MEET THE REQUIREMENTS OF THE PURCHASER'S INTENDED USE.

(c) Purchaser Remedy- Horizon's sole obligation hereunder shall be that Horizon will, at its option, (i) repair or (ii) replace, any Product determined by Horizon to be defective. In the event of a defect, these are the Purchaser's exclusive remedies. Horizon reserves the right to inspect any and all equipment involved in a warranty claim. Repair or replacement decisions are at the sole discretion of Horizon. This warranty does not cover cosmetic damage or damage due to acts of God, accident, misuse, abuse, negligence, commercial use, or modification of or to any part of the Product. This warranty does not cover damage due to improper installation, operation, maintenance, or attempted repair by anyone other than Horizon. Return of any goods by Purchaser must be approved in writing by Horizon before shipment.

Damage Limits

HORIZON SHALL NOT BE LIABLE FOR SPECIAL, INDIRECT OR CONSEQUENTIAL DAMAGES, LOSS OF PROFITS OR PRODUCTION OR COMMERCIAL LOSS IN ANY WAY CONNECTED WITH THE PRODUCT, WHETHER SUCH CLAIM IS BASED IN CONTRACT, WARRANTY, NEGLIGENCE, OR STRICT LIABILITY. Further, in no event shall the liability of Horizon exceed the individual price of the Product on which liability is asserted. As Horizon has no control over use, setup, final assembly, modification or misuse, no liability shall be assumed nor accepted for any resulting damage or injury. By the act of use, setup or assembly, the user accepts all resulting liability.

If you as the Purchaser or user are not prepared to accept the liability associated with the use of this Product, you are advised to return this Product immediately in new and unused condition to the place of purchase.

Law: These Terms are governed by Illinois law (without regard to conflict of law principals).

Safety Precautions

This is a sophisticated hobby Product and not a toy. It must be operated with caution and common sense and requires some basic mechanical ability. Failure to operate this Product in a safe and responsible manner could result in injury or damage to the Product or other property. This Product is not intended for use by children without direct adult supervision. The Product manual contains instructions for safety, operation and maintenance. It is essential to read and follow all the instructions and warnings in the manual, prior to assembly, setup or use, in order to operate correctly and avoid damage or injury.

Questions, Assistance, and Repairs

Your local hobby store and/or place of purchase cannot provide warranty support or repair. Once assembly, setup or use of the Product has been started, you must contact Horizon directly. This will enable Horizon to better answer your questions and service you in the event that you may need any assistance. For questions or assistance, please direct your email to productsupport@horizonhobby.com, or call 877.504.0233 toll free to speak to a service technician.

Inspection or Repairs

If this Product needs to be inspected or repaired, please call for a Return Merchandise Authorization (RMA). Pack the Product securely using a shipping carton. Please note that original boxes may be included, but are not designed to withstand the rigors of shipping without additional protection. Ship via a carrier that provides tracking and insurance for lost or damaged parcels, as **Horizon is not responsible for merchandise until it arrives and is accepted at our facility**. A Service Repair Request is available at www.horizonhobby.com on the "Support" tab. If you do not have internet access, please include a letter with your complete name, street address, email address and phone number where you can be reached during business days, your RMA number, a list of the included items, method of payment for any non-warranty expenses and a brief summary of the problem. Your original sales receipt must also be included for warranty consideration. Be sure your name, address, and RMA number are clearly written on the outside of the shipping carton.

Warranty Inspection and Repairs

To receive warranty service, you must include your original sales receipt verifying the proof-of-purchase date. Provided warranty conditions have been met, your Product will be repaired or replaced free of charge. Repair or replacement decisions are at the sole discretion of Horizon Hobby.

Non-Warranty Repairs

Should your repair not be covered by warranty the repair will be completed and payment will be required without notification or estimate of the expense unless the expense exceeds 50% of the retail purchase cost. By submitting the item for repair you are agreeing to payment of the repair without notification. Repair estimates are available upon request. You must include this request with your repair. Non-warranty repair estimates will be billed a minimum of ½ hour of labor. In addition you will be billed for return freight. Please advise us of your preferred method of payment. Horizon accepts money orders and cashiers checks, as well as Visa, MasterCard, American Express, and Discover cards. If you choose to pay by credit card, please include your credit card number and expiration date. Any repair left unpaid or unclaimed after 90 days will be considered abandoned and will be disposed of accordingly. **Please note: non-warranty repair is only available on electronics and model engines.**

Electronics and engines requiring inspection or repair should be shipped to the following address:

Horizon Service Center
4105 Fieldstone Road
Champaign, Illinois 61822

All other Products requiring warranty inspection or repair should be shipped to the following address:

Horizon Product Support
4105 Fieldstone Road
Champaign, Illinois 61822

Please call 877-504-0233 with any questions or concerns regarding this product or warranty.

Safety, Precautions, and Warnings

This model is controlled by a radio signal that is subject to interference from many sources outside your control. This interference can cause momentary loss of control so it is advisable to always keep a safe distance in all directions around your model, as this margin will help to avoid collisions or injury.

- Always operate your model in an open area away from cars, traffic, or people.
- Avoid operating your model in the street where injury or damage can occur.
- Never operate the model into the street or populated areas for any reason.
- Never operate your model with low transmitter batteries.
- Carefully follow the directions and warnings for this and any optional support equipment (chargers, rechargeable battery packs, etc.) that you use.
- Keep all chemicals, small parts and anything electrical out of the reach of children.
- Moisture causes damage to electronics. Avoid water exposure to all equipment not specifically designed and protected for this purpose.

Contents of Kit

Replacement Parts

A. HAN1251	Fuselage w/Hatch	J. HAN1260	Canopy Hatch
B. HAN1252	Right Wing Panel w/Aileron	K. HAN126L	Fiberglass Painted Cowl
C. HAN1253	Left Wing Panel w/Aileron	L. HAN1263	Landing Gear
D. HAN1254	Right Stabilizer w/Elevator	M. HAN1265	Painted Wheel Pants
E. HAN1255	Left Stabilizer w/Elevator	N. HAN331	Tailwheel Assembly
F. HAN1256	Anodized Wing Tube	O. HAN1266	Hardware Kit
G. HAN1257	Anodized Stabilizer Tube	P. HAN360	Painted Pilot Helmet
H. HAN1258	Rudder		
I. HAN1259	Canopy		
		Not Shown	
		HAN1264	Decal Set

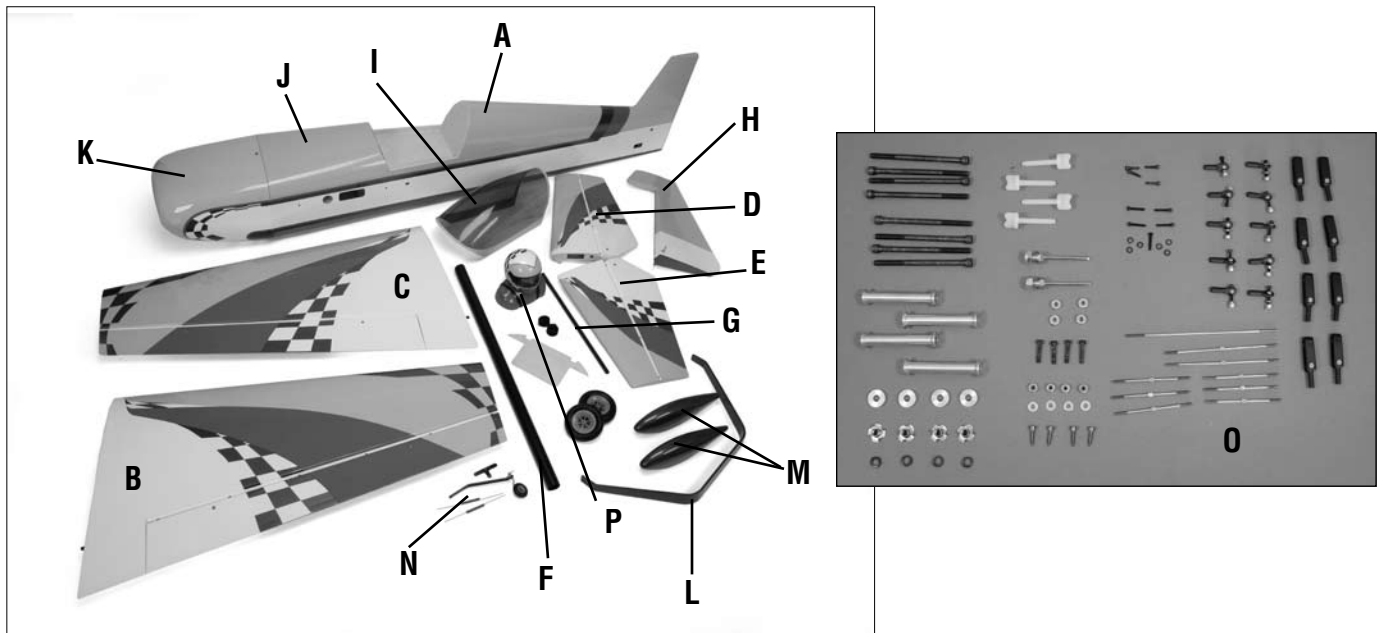

Aileron Servo Installation

Required Parts

- Wing panel (left and right)
- Ball end w/hardware (4)
- Control horn (4)
- 3-inch (76mm) linkage (4)

Required Tools and Adhesives

- JR® MatchBox™ (2)
- Phillips screwdriver
- Ruler
- Nut driver: 1/4-inch
- Hex wrench: 3/32-inch
- String w/weight
- Servo extension, 24-inch (610mm) (2)
- 1 1/2-inch Single Side Alum Adj. Spline Servo Arm (4)

Step 1

Secure a 24-inch (610mm) servo extension to the outboard aileron servo.

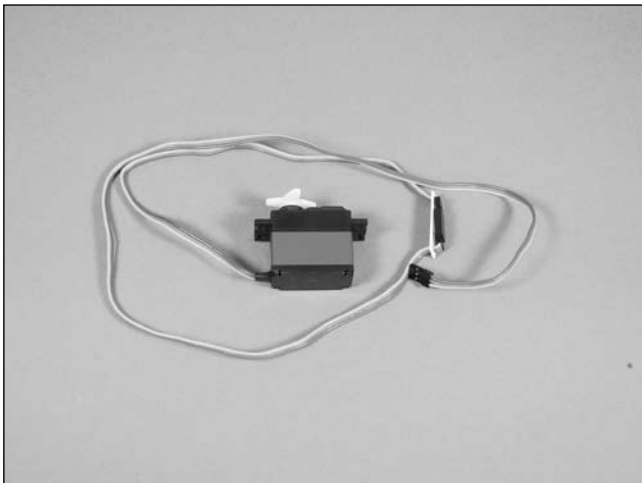

Step 2

Tie a weight to a piece of string. Lower the weight into the opening for the outboard aileron servo.

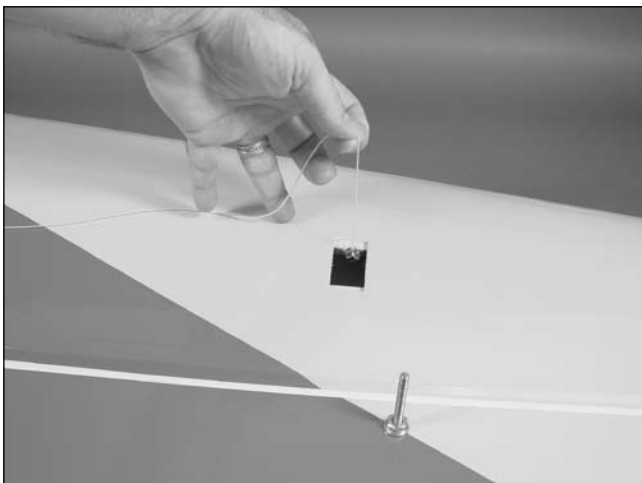

Step 3

Tip the wing so the root is facing down and lower the weight through the wing.

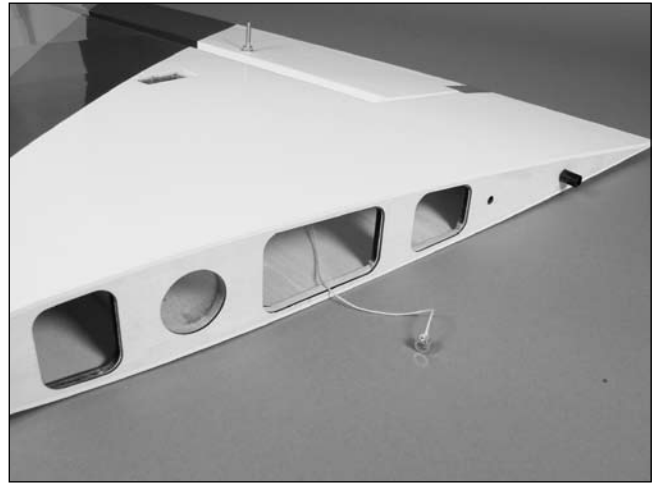

Step 4

Tie the string to the servo extension.

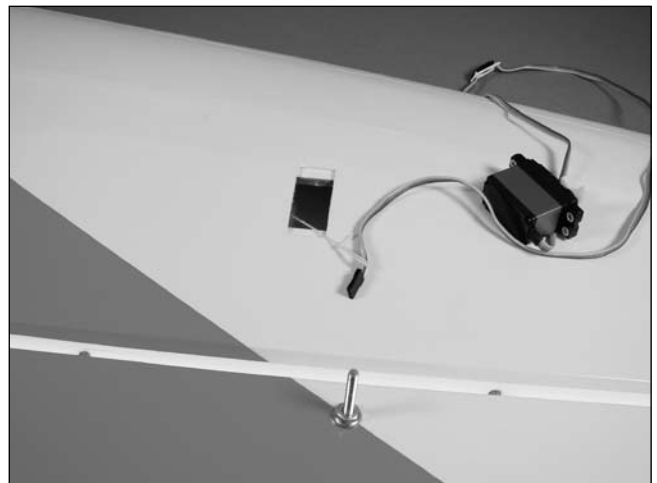

□ □ Step 5

Use the string to pull the extension through the wing. Tape the extension so it will not fall back into the wing.

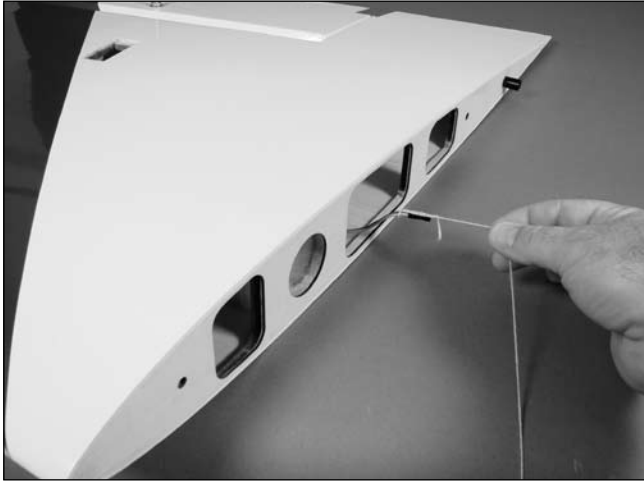

□ □ Step 6

Secure the servo using the hardware provided with the servo. The output of the servo faces the trailing edge.



□ □ Step 7

Thread the control horn onto the control horn screw so the bottom of the horn is 1 inch (25mm) from the surface of the aileron.

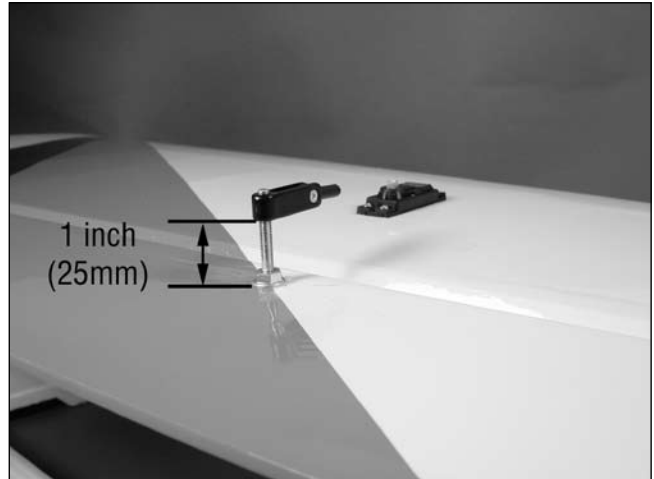

□ □ Step 8

Install the inboard aileron servo and the control horn. Thread the control horn so it is 13/16-inch (21mm) from the aileron surface as shown.

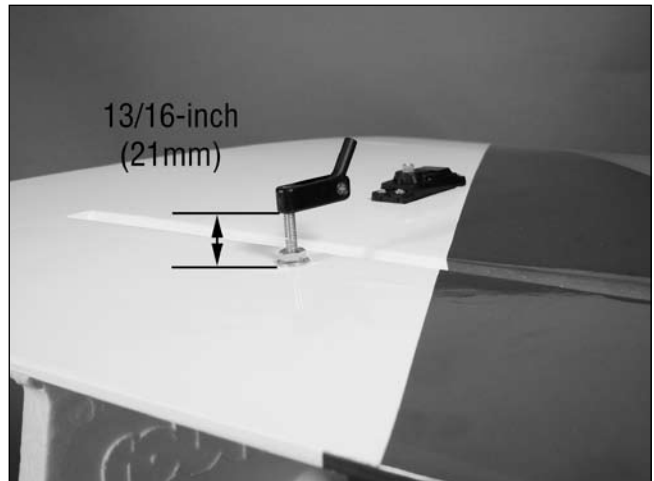

□ □ Step 9

Plug both aileron servos into the receiver. Center the aileron trim and stick to center the aileron servos. Also make sure any sub-trims have been set to zero in the radio memory. Check the operation of the servos at this time.

□ □ Step 10

Attach the ball end to the bottom side of the servo arm using the ball end hardware. The hole used will be $1\frac{1}{4}$ -inch (32mm) from the center of the servo arm.

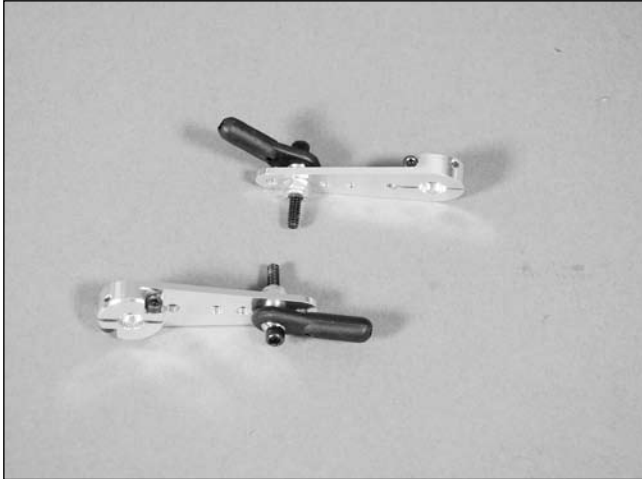

□ □ Step 11

With the servo at the neutral position and radio on, attach the servo arm to the servo. Place it on the spline that sets the arm closest to parallel with the hinge line. (This will be fine tuned later.) Turn off the receiver and manually turn the arm so it is parallel with the hinge line.

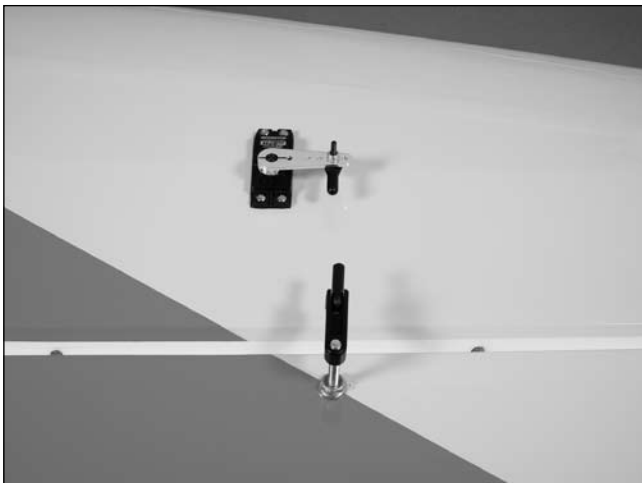

□ □ Step 12

Assemble and install the 3-inch (76mm) linkage for the outboard aileron servo ONLY at this time. Adjust the linkage to center the aileron and attach the linkage to the horn with the setscrew. Remember to keep the servo arm parallel to the hinge line while adjusting the linkage.

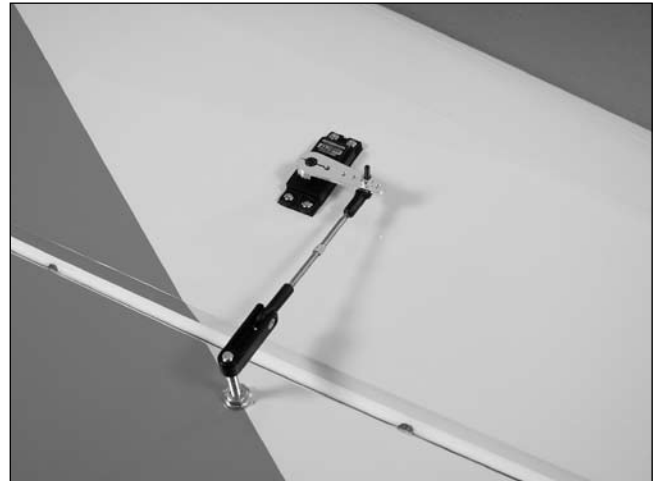

□ □ Step 13

Plug the aileron servos into a JR MatchBox. The outboard servo plugs into Port 1 and the inboard servo plugs into Port 2. The MatchBox is used to link the two servos to operate properly. Plug the MatchBox into the aileron channel of your receiver.

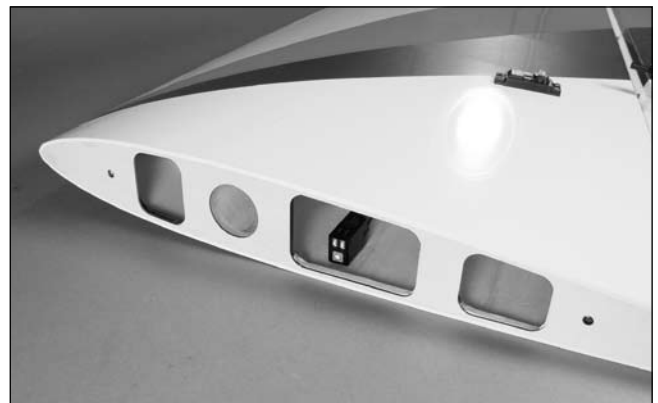

□ □ Step 14

With only the outboard aileron linkage attached to the control horn, turn on the radio and adjust the sub-trim in the transmitter until the aileron is at the neutral position. Deflect the stick to full right aileron and adjust the travel adjust so the deflection is 34.4 degrees. Repeat this for full left deflection and adjust for 33 degrees.

Step 15

Turn the dial on the MatchBox to position 2.

Step 16

Use the MatchBox to adjust the center position of the inboard servo, aligning the servo arm parallel to the hinge line. Assemble and install the 3-inch (76mm) linkage for the outboard aileron servo, but do not attach it to the control horn at this time. Confirm that the hole in the ball end is perfectly aligned with the hole in the control horn.

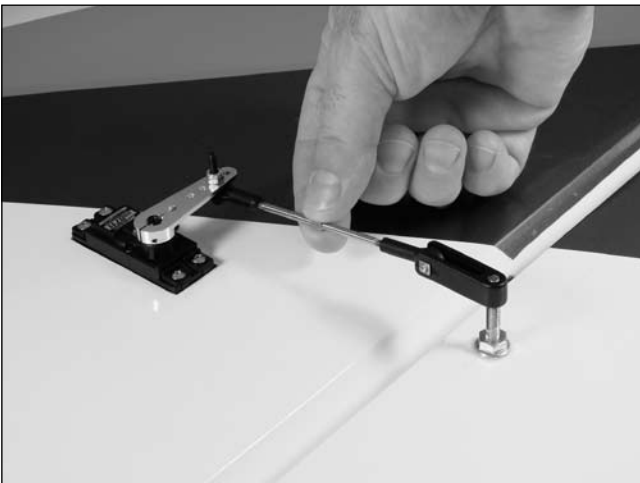

Step 17

Deflect the aileron stick to full right and check the alignment of the hole in the ball end with the hole in the control horn. If they are misaligned (likely), adjust the travel of the servo with the MatchBox while holding full right stick, until the holes align perfectly.



Step 18

Repeat for full left aileron.

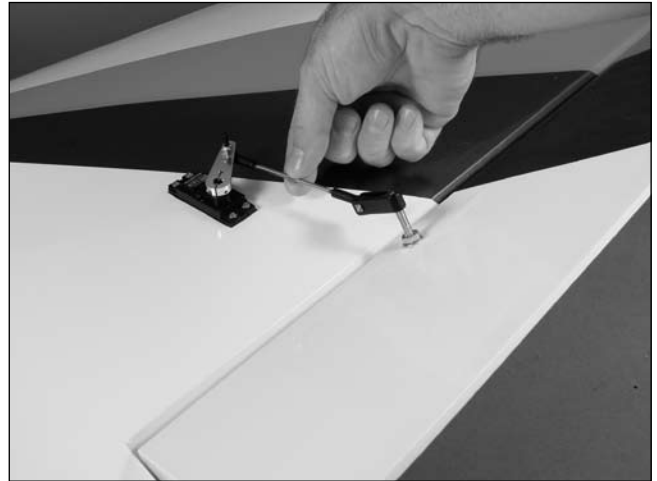

Step 19

BEFORE turning off the power to the receiver, turn the dial on the MatchBox back to the 0 position to save the data.

Step 20

Recheck to be sure the neutral and full deflection in each direction are correct and the holes are aligned in all 3 positions BEFORE securing the ball end to the control horn.

Step 21

Install the screw to secure the ball end to the control horn.



Step 22

Repeat steps 1 through 21 for the remaining wing panel, only plug the matchbox into the auxiliary channel that is being mixed to the aileron channel for this wing panel.

Elevator Servo Installation

Required Parts

- Ball end w/hardware (2)
- Control horn (2)
- Stabilizer/elevator (left and right)
- 3-inch (76mm) linkage (2)

Required Tools and Adhesives

- Hex wrench: 3/32-inch
- Nut driver: 1/4-inch
- 1 1/2-inch Single Side Alum Adj. Spline Servo Arm (2)

□ □ Step 1

Install the elevator servo into the stabilizer. Make sure to pull the servo lead through the opening toward the leading edge before placing the servo.

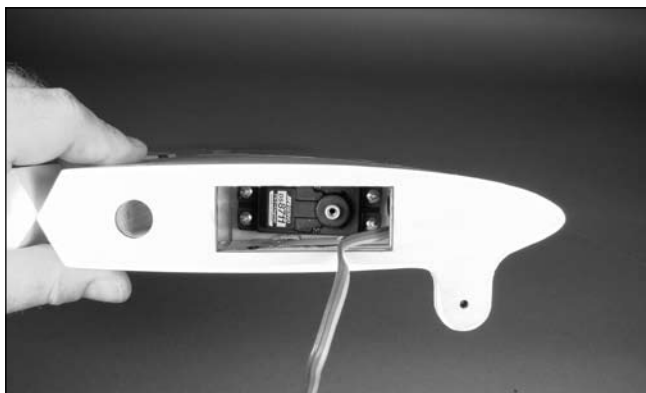

□ □ Step 2

Install the servo arm onto the elevator servo. Use the radio system to center the servo beforehand.

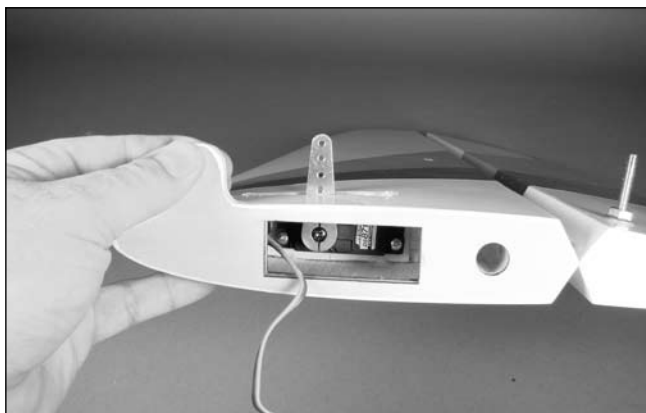

□ □ Step 3

Assemble the linkage for the elevator using a ball end, control horn and a 3-inch (76mm) linkage. Thread the horn onto the screw so the bottom of the horn is 3/4-inch (19mm) from the surface of the elevator.

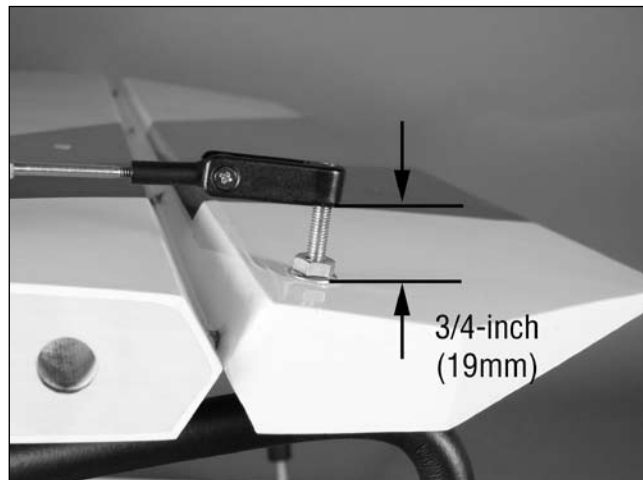

□ □ Step 4

Attach the ball end to the servo horn using the hardware provided with the ball end. The attachment point will be 1 1/2-inch (38mm) from the center of the servo horn.

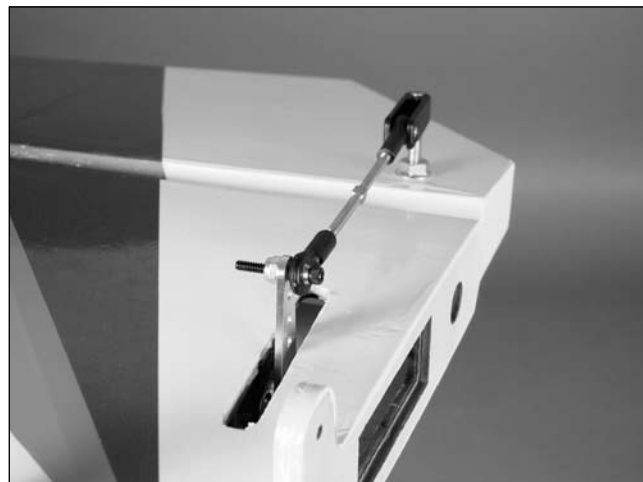

□ Step 5

Repeat Steps 1 through 4 for the remaining elevator servo and linkage.

Rudder and Rudder Servo Installation

Required Parts

- Ball end w/hardware (2)
- Rudder
- Removable hinge pin
- Tail gear assembly
- #6 x 5/8-inch socket head sheet metal screws (4)
- 4 1/2-inch (114mm) linkage
- Control horn (2)
- Fuselage
- Tiller arm
- Steering spring (2)

Required Tools and Adhesives

- Thin CA
- Drill
- Drill bit: 3/32-inch (2.5mm)
- Hex wrench: 3/32-inch
- Nut driver: 1/4-inch
- 1 1/2-inch Single Side Alum Adj. Spline Servo Arm

Note: When using a servo with less than 300 oz/in of torque, it is highly recommended to use two rudder servos and link them together using a JR MatchBox. An additional servo location on the opposite side of the fuselage will require the removal of the covering to install your second servo.

□ Step 1

Secure a 24-inch (610mm) servo extension to the rudder servo. Mount the servo in the fuselage as shown.



□ Step 2

Assemble the rudder linkage using a 4 1/2-inch (114mm) linkage, ball end and control horn. The control horn is then threaded on the control horn screw so the bottom of the horn is 5/8-inch (16mm) from the control surface.

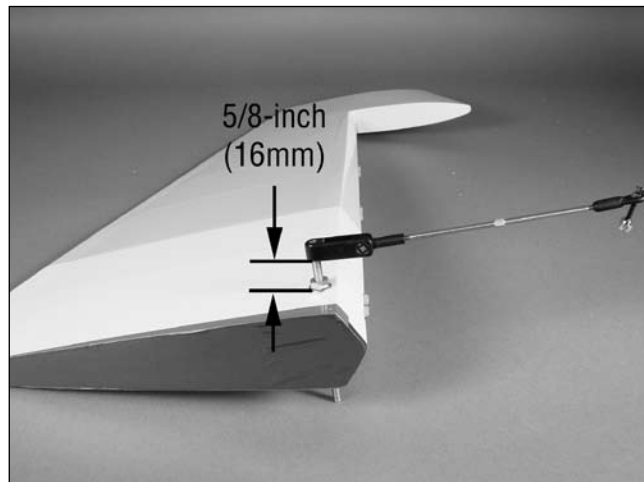

□ Step 3

Attach the rudder to the fin/fuselage using the hinge pin located in the hinges.

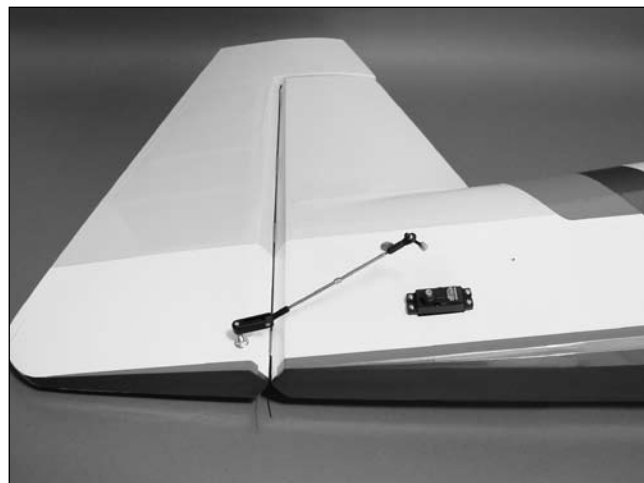

Hint: Use a drill to aid in installing the hinge wire. This will help guide the wire through each of the hinges.

□ Step 4

Attach the ball end to the servo horn using the hardware provided with the ball end. The attachment point will be $1\frac{1}{2}$ -inch (38mm) from the center of the servo horn.



□ Step 5

Position the tail gear assembly on the bottom of the fuselage. Use a felt-tipped pen to mark the locations for the two screws.



Note: The tail gear will keep the rudder hinge in position. You will need to trim the removable hinge pin so it is $\frac{1}{4}$ -inch (4mm) above the tail gear when it has been installed.

□ Step 6

Drill each of the locations using a drill and $\frac{3}{32}$ -inch (2.5mm) drill bit.



□ Step 7

Thread a #6 x $\frac{5}{8}$ -inch socket head sheet metal screw into the holes, then remove the screw.



□ Step 8

Apply a few drops of thin CA into each of the two holes to harden the wood. This will help in preventing the screws from vibrating loose.



□ Step 9

Follow Steps 5 through 8 to attach the tiller arm to the bottom of the rudder with two #6 x 5/8-inch socket head sheet metal screws.



□ Step 10

Attach the tail gear assembly to the bottom of the fuselage using two #6 x 5/8-inch socket head sheet metal screws.



□ Step 11

Complete the rudder installation by connecting the tail wheel to the tiller arm with two steering springs.



Landing Gear Installation

Required Parts

- Fuselage assembly
- Main landing gear
- #8 washer (4)
- 8-32 locknut (4)
- Axle w/nut (2)
- #4 washer (4)
- 4-40 blind nut (4)
- 4 1/2-inch (114mm) wheel (2)
- 4-40 x 1/2-inch socket head screw (4)
- 5/32-inch wheel collar w/setscrews (4)

Required Tools and Adhesives

- Threadlock
- Drill
- Drill bit: 9/64-inch (3.5mm)
- Hex wrench: .050-inch, 3/32-inch

Step 1

Attach the landing gear to the fuselage using four 8-32 x 3/4-inch socket head screws, four #8 washers and four 8-32 lock nuts.



Step 2

Secure the axle to the main landing gear.

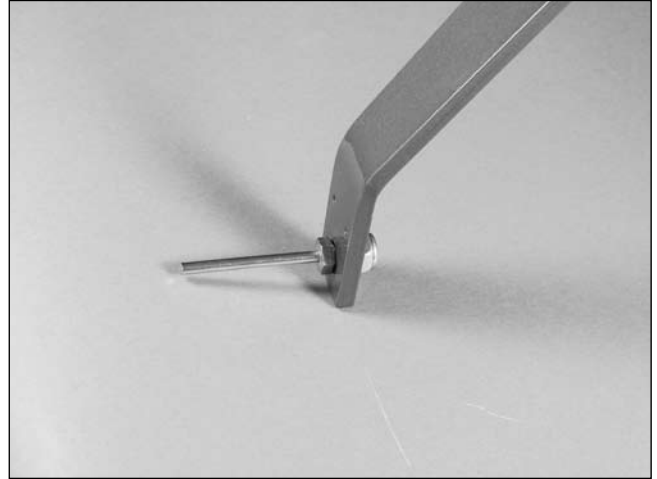

Step 3

Use a file to create a flat on the axle for the setscrews in the collars to tighten onto. This will help in preventing them from loosening in flight.



□ Step 3

Attach the wheel to the axle using two 5/32-inch wheel collars. The collars are placed on either side of the wheel.



Note: Always use threadlock on metal-to-metal fasteners to prevent them from vibrating loose.

□ Step 4

Place the fuselage on a level surface. Slide the wheel pant into position. The pant must be positioned so it will not come in contact with the surface.

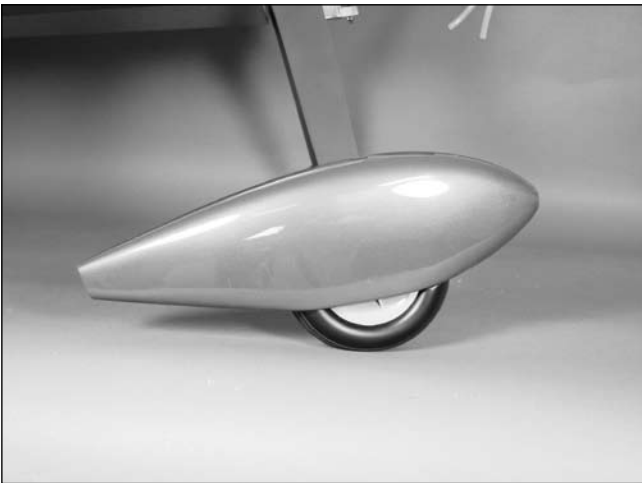

□ Step 5

Mark the location for the two screws through the landing gear and onto the wheel pant using a felt-tipped pen.

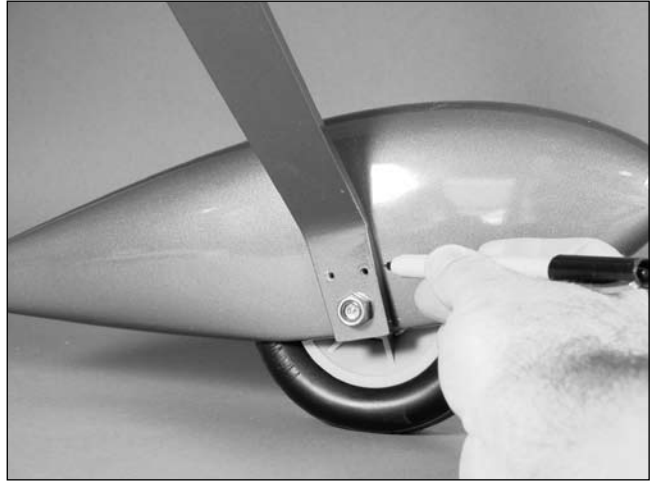

□ Step 6

Drill the locations marked in the previous step using a drill and 9/64-inch (3.5mm) drill bit.



Step 7

Use pliers to install the two 4-40 blind nuts in the wheel pant as shown.

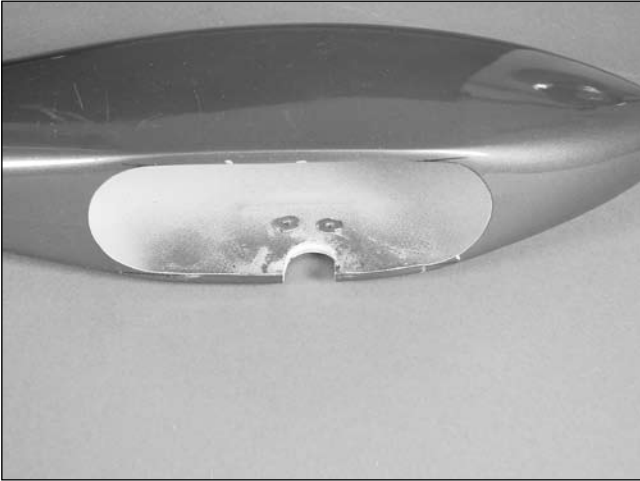

Step 8

Secure the wheel pant to the landing gear using two 4-40 x 1/2-inch socket head screws and two #4 washers.

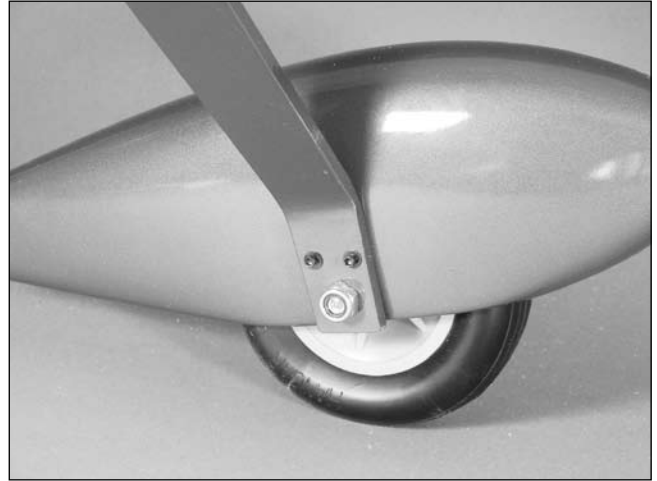

Note: Always use threadlock on metal-to-metal fasteners to prevent them from vibrating loose.

Stabilizer Installation

Required Parts

- Fuselage assembly
- Stabilizer/elevator (2)
- Stabilizer tube
- #4 washer (4)
- 4-40 x 1/2-inch socket head screw(4)

Required Tools and Adhesives

- Threadlock
- Hobby knife
- Hex wrench: 3/32-inch
- Tap handle
- 4-40 tap
- Drill
- Drill bit: 1/16-inch (1.5mm), 1/8-inch (3mm)

Step 1

Slide the stabilizer tube into one of the stabilizer halves.

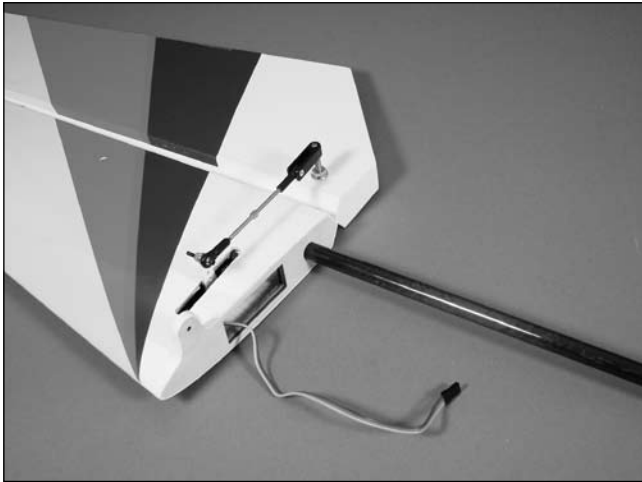

Step 2

Use a hobby knife to remove the covering from the opening in the fuselage for the servo lead.

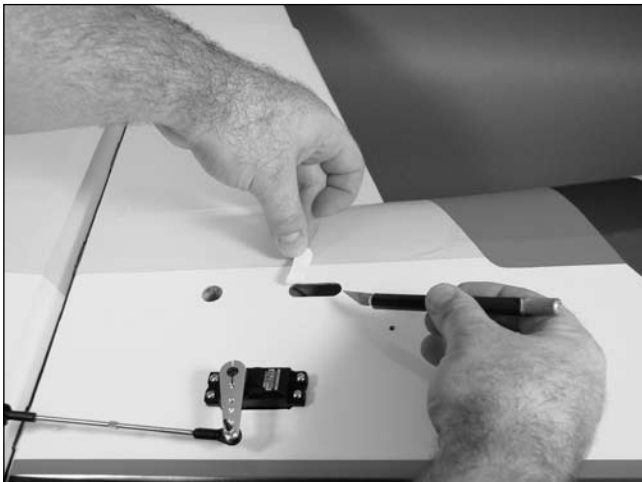

Step 3

Secure a 24-inch (610mm) servo extension to the elevator servo lead. Pass the extension into the fuselage, then slide the tube into the fuselage.

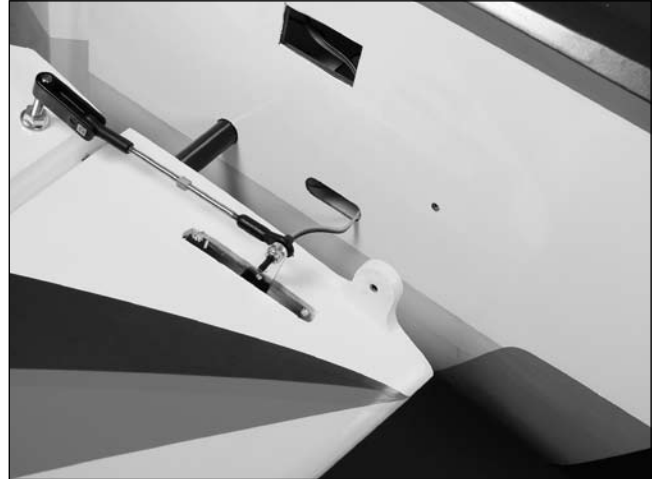

Step 4

Use a 4-40 x 1/2-inch socket head screw and #4 washer to secure the position of the stabilizer.



Note: Always use threadlock on metal-to-metal fasteners to prevent them from vibrating loose.

Step 5

Repeat Steps 2 through 4 for the remaining stabilizer.

Step 6

Drill a pilot hole in the stabilizer tube using a drill and 1/16-inch (1.5mm) drill bit.

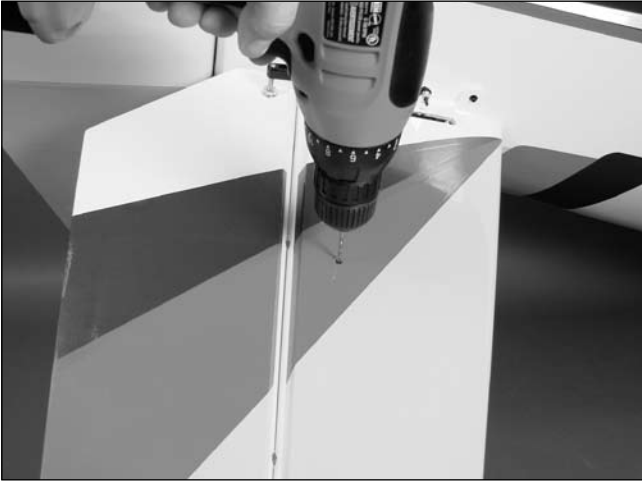

Step 7

Remove the stabilizer tube and use a drill and 1/8-inch (3mm) drill bit to drill a hole in the stabilizer tube.

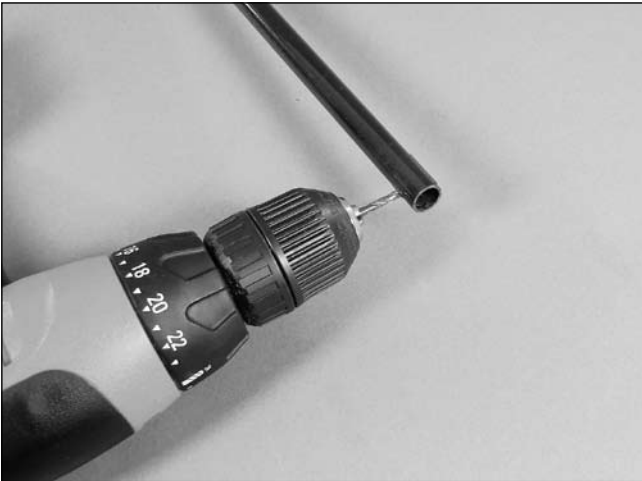

Step 8

Secure the position of the tube using a 4-40 x 1/2-inch socket head screw and #4 washer. The screw will thread into a blind nut that is installed inside the stabilizer.

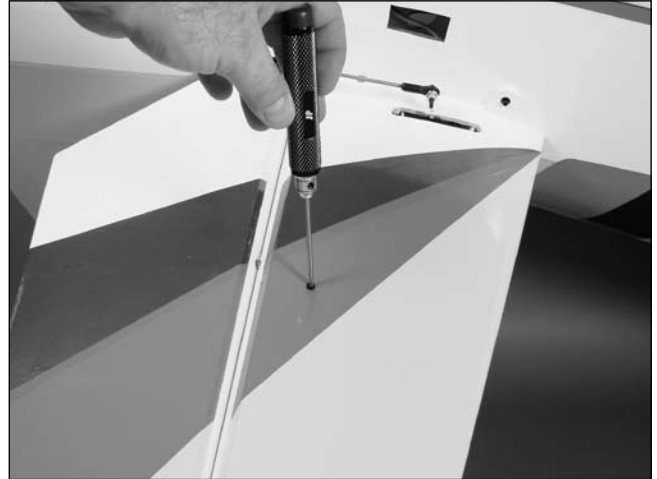

Step 9

Repeat Steps 6 through 8 for the remaining stab tube screw.

Engine Installation (DA100)

Required Parts

- Fuselage assembly

Required Tools and Adhesives

- Threadlock

Note: For simplicity the DA will be shown with canister installation and the Evolution with Muffler installation. Either engine can be used with either exhaust option.

□ Step 1

Collect the items shown for the installation of your particular engine.



□ Step 2

Measure mark and drill firewall to correct dimensions and offset to the left side.

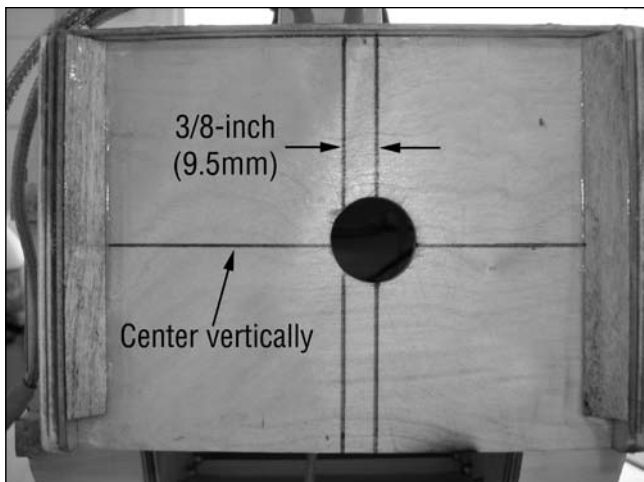

□ Step 3

Use a drill and 5/16-inch (8mm) drill bit to drill the holes in the firewall for mounting the engine.

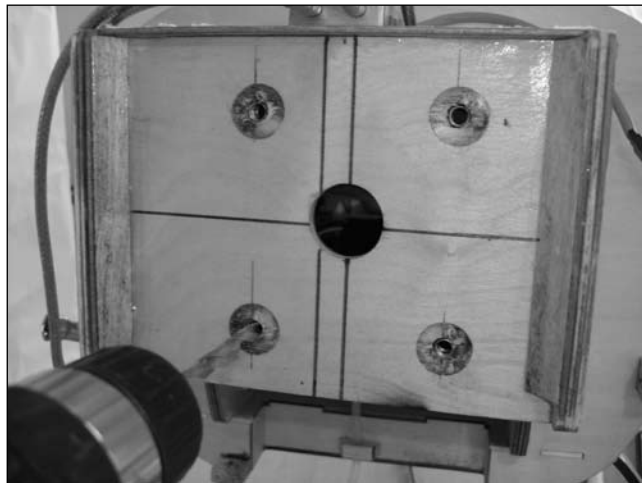

□ Step 4

Install the 1/4-20 blind nuts from the back side of the firewall. You can use the bolts and standoffs to pull the blind nuts into position.

□ Step 5

Install engine using four 2⁷/₈-inch (73mm) machined aluminum standoffs and four 1/4-20 x 3³/₄-inch socket head bolts and four 1/4-inch lock washers.

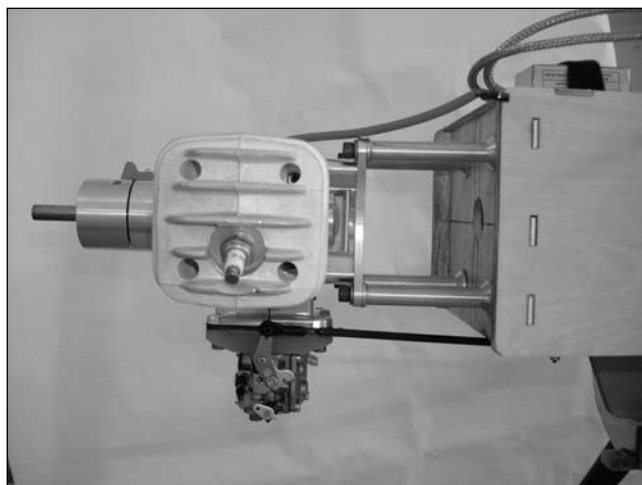

□ **Step 6**

Use a hobby knife to trim the covering from the opening on the bottom of the fuselage. Leave enough material that you can use the covering to seal the opening with a covering iron.



□ **Step 7**

Install silicone tubes (8 total) in each of the two canister mounts.

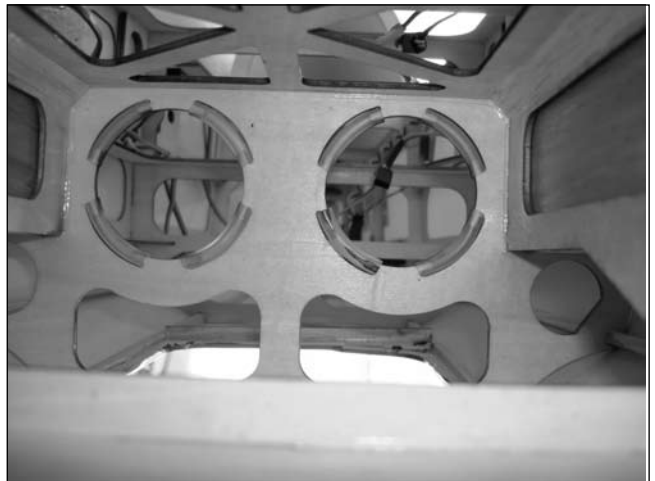

□ Step 8

Install throttle servo and attach the linkage (supplied) with a 4-40 ball link on each end.

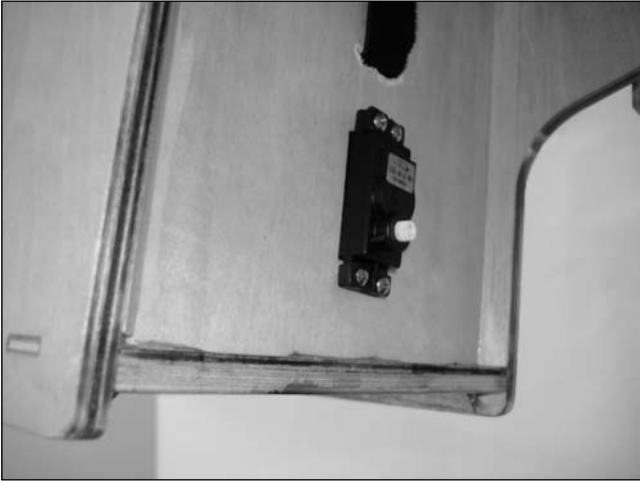

□ Step 9

Slide the canister mufflers into model and attach the headers to the engine.

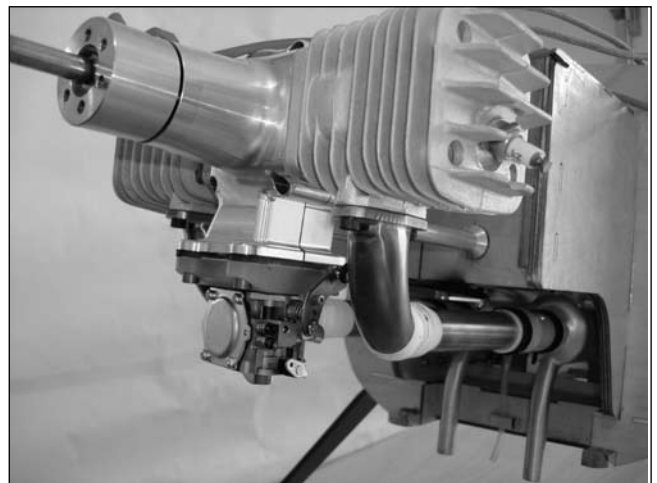

□ Step 10

Secure the ignition module to the engine box. Make the connections between the ignition box and engine at this time.

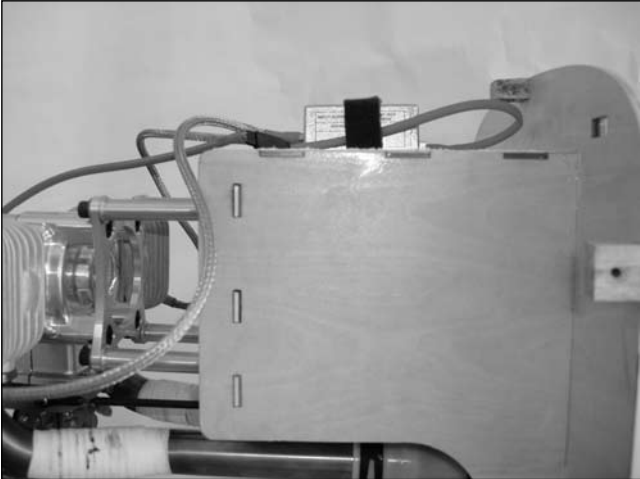

□ Step 11

Install the switch for the ignition at the front of the fuselage as shown.



□ Step 12

Secure the battery for the ignition inside the fuselage using a hook and loop strap. Make sure to add a few pieces of foam between the fuselage and battery to prevent damage to the battery caused by vibration. Connect the battery to the ignition switch.



□ Step 13

Attach the fuel line from the fuel tank to the carburetor. Make sure the line is from the clunk and not the vent line.

Step 14

Cut the line between the carburetor and fuel tank to install a Fuel Dot (HAN115). This will make fueling the tank much easier when the cowl is installed.

Step 15

Route the vent line from the fuel tank out the bottom of the cowl.



Step 16

Make any necessary cutouts to clear the engine components in the cowl. Remove a section from the bottom of the cowling near the mufflers for cooling outlet as shown. This opening is necessary to allow cooling air to pass through the cowling to prevent overheating of your engine.

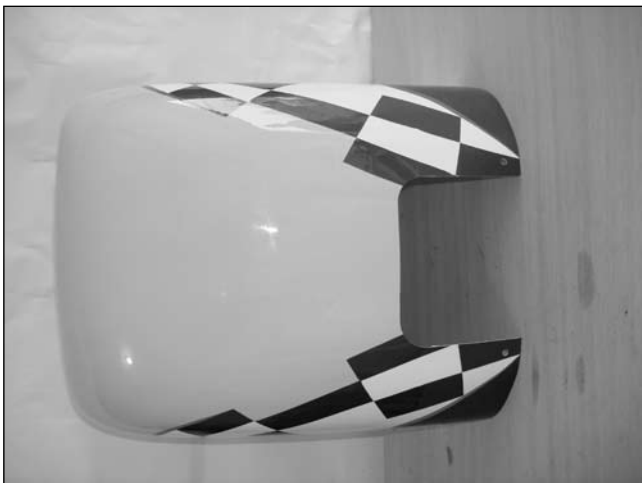

Step 17

Make a circular opening under the carb in the cowling so the choke butterfly can be manually operated.



Engine Installation (Evolution 116GX)

Required Parts

- Fuselage assembly

Required Tools and Adhesives

- Threadlock

□ Step 1

Collect the items shown for the installation of your particular engine.

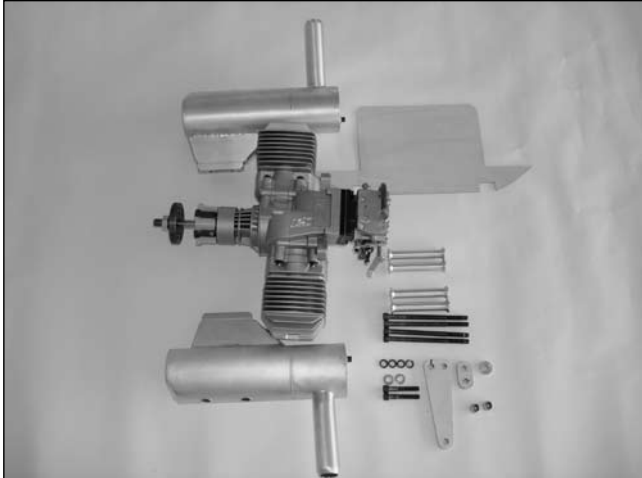

□ Step 2

Install the short aluminum adapter to the top left mounting hole on the engine using the short 1/4-20 bolt and aircraft nut. Don't tighten yet.



□ Step 3

Install the tapered aluminum adapter plate to the right side of the engine with a short 1/4-20 bolt and AC nut through the top mounting hole and don't tighten yet.

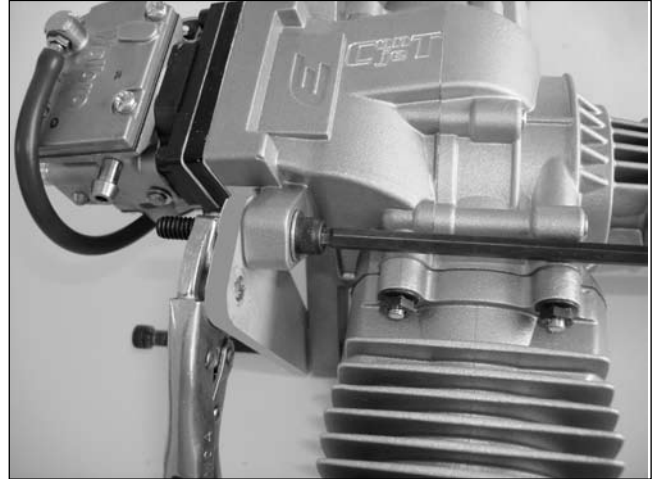

□ Step 4

Measure, mark and drill firewall to correct dimensions and offset to the left side.

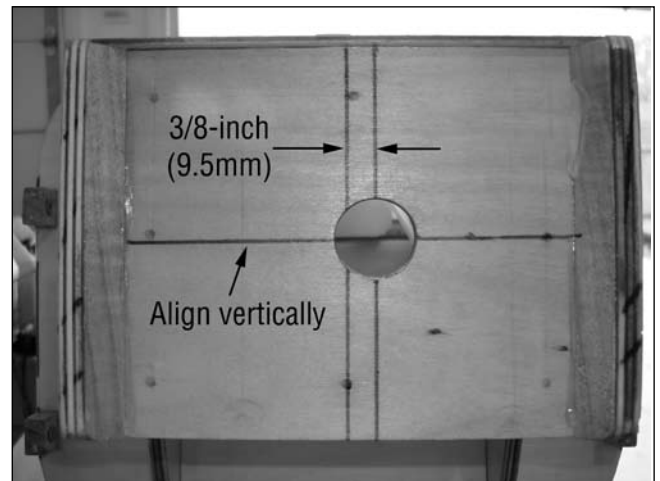

□ Step 3

Use a drill and 5/16-inch (8mm) drill bit to drill the holes in the firewall for mounting the engine.

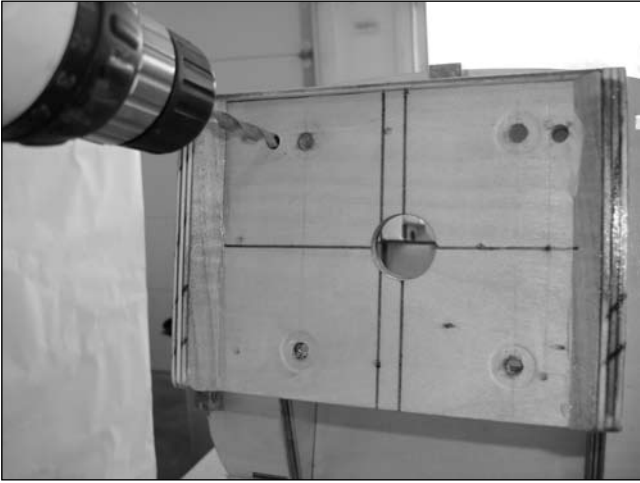

□ Step 5

Install the 1/4-20 blind nuts from the back side of the firewall. You can use the bolts and standoffs to pull the blind nuts into position.

□ Step 6

Install engine using four 2⁷/₈-inch (73mm) machined aluminum standoffs, one 3/16-inch (5mm) aluminum spacers and four 1/4-20 x 4-inch socket head bolts and four 1/4-inch lock washers.



□ Step 7

Cut the top of the motor box to mount the throttle servo as photos and install it top down.



□ Step 8

Drill a hole in the firewall for the throttle linkage to pass.

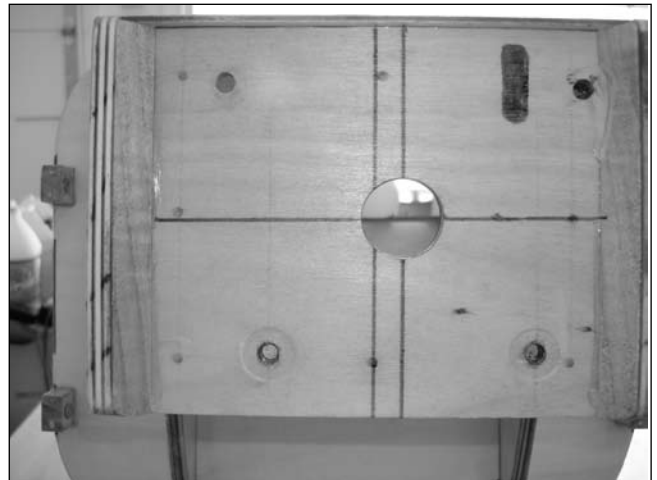

Step 9

Install the (supplied) throttle linkage.



Step 10

Attach the fuel line from the fuel tank to the carburetor. Make sure the line is from the clunk and not the vent line. Cut the line between the carburetor and fuel tank to install a Fuel Dot (HAN115). This will make fueling the tank much easier when the cowl is installed.

Step 11

Secure the battery for the ignition inside the fuselage using a hook and loop strap. Make sure to add a few pieces of foam between the fuselage and battery to prevent damage to the battery caused by vibration. Connect the battery to the ignition switch. The EVO 116 requires a 3-cell Li-Po ignition battery.



Step 12

Use 30-minute epoxy to glue in cover plate to the fuselage for pipe tunnel.

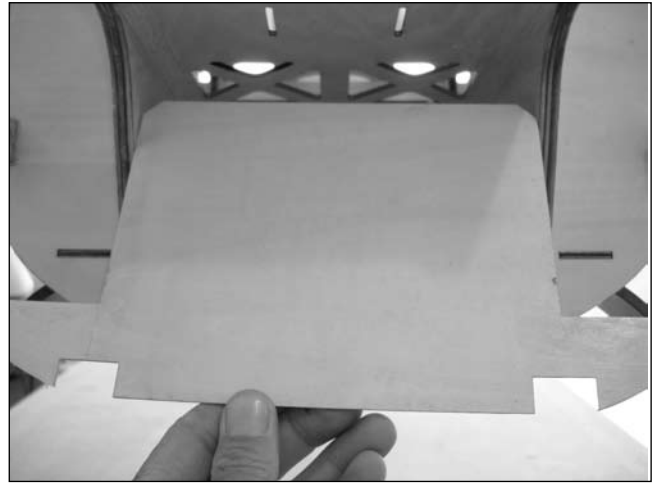

Step 13

Bolt the mufflers onto engine using the hardware provided with the mufflers.

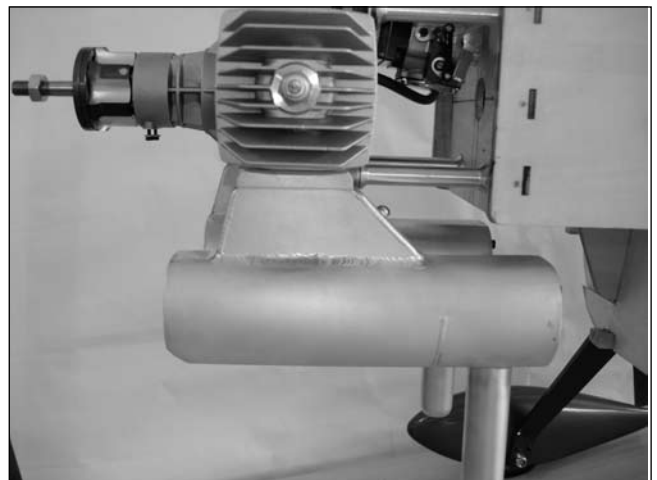

Step 14

Make any necessary cutouts to clear the engine components in the cowl. Remove a section from the bottom of the cowling near the mufflers for cooling outlet as shown. This opening is necessary to allow cooling air to pass through the cowling to prevent overheating of your engine.

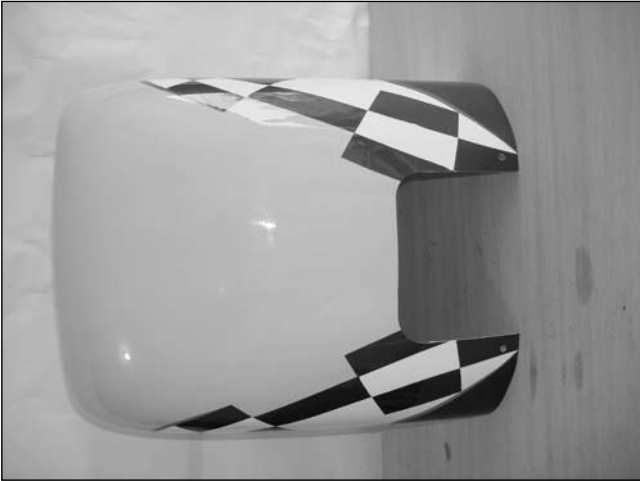

Step 15

Route the vent line from the fuel tank out the bottom of the cowl.



Receiver Installation

Required Parts

- Fuselage assembly
- Hook and loop strap (4)

Required Tools and Adhesives

- Threadlock
- Receiver
- 1/4-inch (6mm) foam
- Ignition battery
- 24-Inch Servo Lead Extension (JSP98040) (3)
- 36-inch Servo Lead Extension (JSP98050) (3)
- Hobby knife
- Switch harness
- Receiver battery

IMPORTANT: Two receiver batteries of at least 2700mAh or larger are needed. Two 4000 2S2P Li-Po receiver packs are shown.

Step 1

Install both receiver batteries with two layers of padded 2-sided servo tape and then secure in place with the supplied hook and loop straps.



□ Step 4

Use a hobby knife to remove the covering from the holes in the sides of the fuselage for the two radio switches.



□ Step 7

Secure any switches to the fuselage using the hardware provided with the switches.



□ Step 10

Put foam rubber or thick padded 2-sided tape under the receiver. Use a hook and loop strap to secure the receiver to the cross brace inside the fuselage. Plug the servos into the receiver and route the servo leads neatly along the side of the fuselage. Route the antenna wire (if necessary) at this time as well.

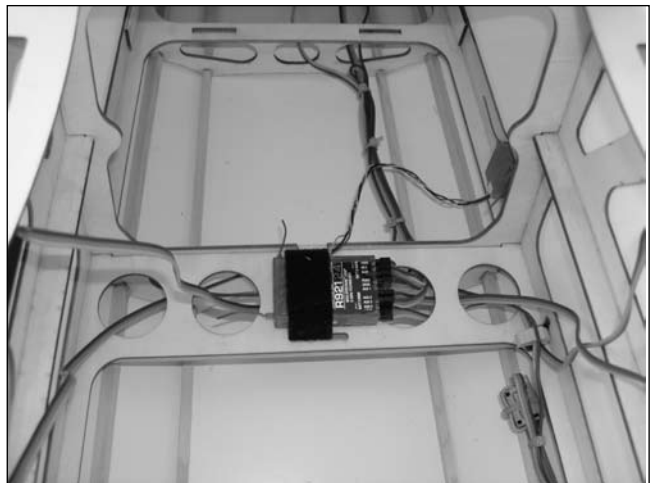

Pilot and Canopy Installation

Required Parts

- Fuselage assembly
- Pilot bust
- Canopy

Required Tools and Adhesives

- Canopy glue
- Felt-tipped pen
- Painter's tape
- Waxed paper
- 30-minute epoxy
- Sandpaper
- Rubbing alcohol
- Paper towel

□ Step 1

Be sure the visor screws are tight. It is recommended to remove the screws and use a drop of threadlock on them to prevent vibrations from causing them to vibrate loose.



□ Step 2

Use 30-minute epoxy to secure the pilot bust to the canopy hatch.



□ Step 3

Trim the instrument panel from the decal sheet. Apply the decal in position in the cockpit.

□ Step 4

Position the canopy onto the hatch. Use a felt-tipped pen to trace the outline of the canopy onto the hatch.



□ Step 5

Sand the hatch and canopy where they contact each other using sandpaper. Clean the area using rubbing alcohol and a paper towel.



□ Step 6

Slip a piece of waxed paper between the hatch and fuselage. Use canopy glue to attach the canopy to the canopy hatch. Use painter's tape to keep the canopy in position until the glue fully cures.



Radio Setup

A 7-channel or greater computer radio is highly recommended. This allows the following features:

- Mixing the right aileron to the left aileron (flaperon mix)
- Electronically adjustable aileron differential
- Mixing the right elevator to the left elevator (dual elevator mixing)
- Independent travel and trim adjustments for each elevator half

When using a 7-Channel or greater computer radio, each servo is plugged into its own separate channel. Consult your radio manual for specific details on hookup and programming.

Control Throws

Setting the control throws for your Extra 260 does require some attention to detail. To correctly set the throws, it is highly suggested to use the following procedure to achieve the greatest mechanical advantage from your servos.

Step 1

Determine the maximum amount of control surface throw from the throws listed. Use the high rate throws listed to set the maximum amount of throw, then use your computer radio for the lower rate listed.

Step 2

Set the Travel Adjust (ATV on a Futaba transmitter) to about 15% under the max. (On a JR transmitter, that is 135%.) Make sure to set both directions during this process.

Step 3

Adjust the position of the clevis on the control horn and position of the ball link on the servo arm to achieve the throw decided in Step 1. It is highly recommended not to change the position on the servo arm unless absolutely necessary. Use Travel Adjust (ATV) to finalize the throws. That is why we left a little margin in the percentages back in Step 2.

Step 4

If setting a dual elevator or aileron, match the linkage locations used back in Step 3. Increase or decrease the Travel Adjust (ATV) a few points as necessary to fine-tune the throws to match up left and right sides and up and down throws so all is symmetrical.

This is all necessary to tune the mechanical advantage as good as possible. When setting up a model for 3D, the mechanical advantage will be less because of the large throws, and thus the servo will work harder and wear faster. Using an insufficient servo for the job, or trying to get too much throw, will cause something to give, probably the servo.

There isn't an exact geometry to the linkage, as it depends on how much throw each individual modeler requires. The linkage geometry should always be maximized so the servo isn't working any harder than it has to.

Aileron:

High Rate: 34.4 Degrees up, 54% Exponential
33 Degrees down, 54% Exponential
Low Rate: 23 Degrees up, 40% Exponential
22 Degrees down, 40% Exponential

Elevator:

High Rate: 48.5 Degrees up, 75% Exponential
47 Degrees down, 75% Exponential
Low Rate: 13 Degrees up, 45% Exponential
13 Degrees down, 45% Exponential

Rudder:

High Rate: 44 Degrees right, 50% Exponential
44 Degrees left, 50% Exponential
Low Rate: 30 Degrees right, 50% Exponential
30 Degrees left, 50% Exponential

Computer Radio Enhancements

A computer radio will allow you to do quite a bit of fine-tuning to the feel of the Extra 260, which will make aerobatics even easier.

Rates and Expos

Use Expo to soften the feel of the model. On high 3D rates, use quite a bit of expo. The goal on 3D rates is to get the model to feel the same around neutral as it does on low rates.

Use low rate settings for all flying except for 3D aerobatics. For precision flying or general sport hot-dogging, the low rate throws are perfect, even for snap rolls. The only exception is rudder rates. Use 3D rudder rate when doing stall turns and rolling circles, since the more rudder the better for these. When doing 3D aerobatics, flip to 3D rates just before the maneuver. As soon as the maneuver is done, flip back down to low rate to avoid over-controlling the model.

Recommended Center of Gravity (CG)

An important part of preparing the aircraft for flight is properly balancing the model. This is especially important when various engines are mounted.

Caution: Do not inadvertently skip this step!

The recommended Center of Gravity (CG) location for your model is: 3 1/2 to 4 inches (89 to 102mm) back from leading edge of wing at the wing tip. Mark the location of the CG onto the bottom of the wing using a felt-tipped pen. With a helper, lift the aircraft with your index finger at the location marked on the wing. Make sure the aircraft is upright when checking the CG. If the nose of your aircraft hangs low, add weight to the rear of the aircraft. If the tail hangs low, add weight to the nose of the aircraft. Stick-on weights are available at your local hobby store and work well for this purpose.

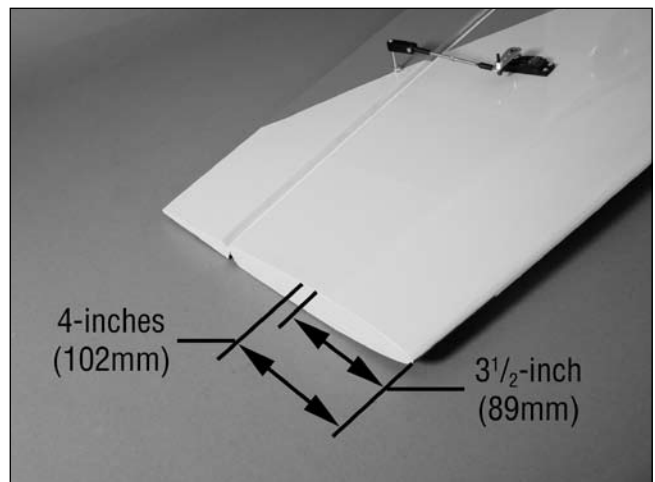

Preflight

For those of you who are veterans of large models, this is old news. But to you newcomers to the world of large models, this is very important information.

While many smaller models are not critical of proper battery use, and are tolerant of improper control linkage setups and flying techniques, large models are not. Don't let that scare you away from large models; they are truly one of the best flying experiences in RC that money can buy. However, please pay particular attention to the following areas.

Maintain the proper mechanical advantage on all control surface linkages.

Just as with unsealed hinge gaps, mechanical advantage is often another cause of flutter. Please follow the control horn and servo arm lengths recommended in this manual. Shorter arms on the servo or longer control horns on the elevator and ailerons are fine, but do not try to go the other way to increase throw. It can cause flutter or servo failure on the Extra 260. The recommended linkage setups are more than adequate to achieve full 3D throws.

Check the radio installation and make sure all the control surfaces are moving correctly (i.e. the correct direction and with the recommended throws). Test run the engine and make sure it transitions smoothly from idle to full throttle and back. Also ensure the engine is tuned according to the manufacturer's instructions, and it will run consistently and constantly at full throttle when adjusted.

Check all the control horns, servo horns, and clevises to make sure they are secure and in good condition. Replace any items that would be considered questionable. Failure of any of these components in flight would mean the loss of your aircraft.

While many smaller models are very tolerant of improper control linkage setups and flying techniques, large models are not. Don't let that scare you away from large models; they are truly one of the best flying experiences in RC that money can buy. However, please pay particular attention to the following areas.

Never attempt to make full throttle dives!

Large models perform much more like full-size aircraft than small models. If the airframe goes too fast, such as in a high throttle dive, it may fail. The Extra 260 should be flown like a full-scale Extra 260. Throttle management is absolutely necessary.

Hardware checks

Double-check the setscrews in all control horns to be sure they are very tight. Periodically check these to be sure they have not loosened over time. Always use threadlock on metal-to-metal fasteners.

Receiver Battery Selection

Be sure adequate batteries are used to power the receiver. It is **STRONGLY** recommended that two identical 6-volt receiver packs are used. Each pack must have a minimum of 2700mAh capacity. Use packs of 3000mAh when super high torque servos are used.

Servo selection

Be sure all servos used on elevator, aileron and rudder are metal geared type and have at least 188 oz in of torque. Failure to do this will very likely result in a failure and loss of the model.

Range check

Always range check the radio system per the manufacturer's instructions before the initial test flight and periodically afterward.

Check the voltage of the on-board packs

ALWAYS use an ESV with a 1-amp load to check the receiver battery packs and the ignition pack before each and every flight. If there is any doubt that the packs are questionable, **DO NOT FLY** until the packs are recharged.

Instructions for Disposal of WEEE by Users in the European Union

This product must not be disposed of with other waste. Instead, it is the user's responsibility to dispose of their waste equipment by handing it over to a designated collection point for the recycling of waste electrical and electronic equipment. The separate collection and recycling of your waste equipment at the time of disposal

will help to conserve natural resources and ensure that it is recycled in a manner that protects human health and the environment. For more information about where you can drop off your waste equipment for recycling, please contact your local city office, your household waste disposal service or where you purchased the product.



2007 Official AMA National Model Aircraft Safety Code

GENERAL

1. A model aircraft shall be defined as a non-human-carrying device capable of sustained flight in the atmosphere. It shall not exceed limitations established in this code and is intended to be used exclusively for recreational or competition activity.
2. The maximum takeoff weight of a model aircraft, including fuel, is 55 pounds, except for those flown under the AMA Experimental Aircraft Rules.
3. I will abide by this Safety Code and all rules established for the flying site I use. I will not willfully fly my model aircraft in a reckless and/or dangerous manner.
4. I will not fly my model aircraft in sanctioned events, air shows, or model demonstrations until it has been proven airworthy.
5. I will not fly my model aircraft higher than approximately 400 feet above ground level, when within three (3) miles of an airport without notifying the airport operator. I will yield the right-of-way and avoid flying in the proximity of full-scale aircraft, utilizing a spotter when appropriate.
6. I will not fly my model aircraft unless it is identified with my name and address, or AMA number, inside or affixed to the outside of the model aircraft. This does not apply to model aircraft flown indoors.
7. I will not operate model aircraft with metal-blade propellers or with gaseous boosts (other than air), nor will I operate model aircraft with fuels containing tetranitromethane or hydrazine.
8. I will not operate model aircraft carrying pyrotechnic devices which explode burn, or propel a projectile of any kind. Exceptions include Free Flight fuses or devices that burn producing smoke and are securely attached to the model aircraft during flight. Rocket motors up to a G-series size may be used, provided they remain firmly attached to the model aircraft during flight. Model rockets may be flown in accordance with the National Model Rocketry Safety Code; however, they may not be launched from model aircraft. Officially designated AMA Air Show Teams (AST) are authorized to use devices and practices as defined within the Air Show Advisory Committee Document.
9. I will not operate my model aircraft while under the influence of alcohol or within eight (8) hours of having consumed alcohol.
10. I will not operate my model aircraft while using any drug which could adversely affect my ability to safely control my model aircraft.
11. Children under six (6) years old are only allowed on a flightline or in a flight area as a pilot or while under flight instruction.
12. When and where required by rule, helmets must be properly worn and fastened. They must be OSHA, DOT, ANSI, SNELL or NOCSAE approved or comply with comparable standards.

2007 Official AMA National Model Aircraft Safety Code

Radio Control

1. All model flying shall be conducted in a manner to avoid over flight of unprotected people.
2. I will have completed a successful radio equipment ground-range check before the first flight of a new or repaired model aircraft.
3. I will not fly my model aircraft in the presence of spectators until I become a proficient flier, unless I am assisted by an experienced pilot.
4. At all flying sites a line must be established, in front of which all flying takes place. Only personnel associated with flying the model aircraft are allowed at or in front of the line. In the case of airshows demonstrations straight line must be established. An area away from the line must be maintained for spectators. Intentional flying behind the line is prohibited.
5. I will operate my model aircraft using only radio-control frequencies currently allowed by the Federal Communications Commission (FCC). Only individuals properly licensed by the FCC are authorized to operate equipment on Amateur Band frequencies.
6. I will not knowingly operate my model aircraft within three (3) miles of any preexisting flying site without a frequency-management agreement. A frequency-management agreement may be an allocation of frequencies for each site, a day-use agreement between sites, or testing which determines that no interference exists. A frequency-management agreement may exist between two or more AMA chartered clubs, AMA clubs and individual AMA members, or individual AMA members. Frequency-management agreements, including an interference test report if the agreement indicates no interference exists, will be signed by all parties and copies provided to AMA Headquarters.
7. With the exception of events flown under official AMA rules, no powered model may be flown outdoors closer than 25 feet to any individual, except for the pilot and located at the flight line.
8. Under no circumstances may a pilot or other person touch a model aircraft in flight while it is still under power, except to divert it from striking an individual.
9. Radio-controlled night flying is limited to low-performance model aircraft (less than 100 mph). The model aircraft must be equipped with a lighting system which clearly defines the aircraft's attitude and direction at all times.
10. The operator of a radio-controlled model aircraft shall control it during the entire flight, maintaining visual contact without enhancement other than by corrective lenses that are prescribed for the pilot. No model aircraft shall be equipped with devices which allow it to be flown to a selected location which is beyond the visual range of the pilot.



Fly First Class™



© 2007 Horizon Hobby, Inc.
4105 Fieldstone Road
Champaign, Illinois 61822
(877) 504-0233
horizonhobby.com