

STILETTO



Bind-N-Drive.™ Ready to run, redefined.

Owners Manual



Specifications

Length	30.125 in (765mm)
Overall Length	35.75 in (908mm)
Beam.....	11.0 in (279mm)
Height.....	6.75 in (171mm)
Motor.....	A3630 1800Kv Water-cooled Brushless
Servo.....	Spektrum S100 Metal Gear Hi-torque
Receiver.....	Spektrum 2.4GHz Marine
Speed Control.....	60-amp Waterproof Brushless
Hull Material	Fiberglass Composite
Battery	7.4V 2S 25C Li-Po or 7.2V Sub-C with Deans Connector (2) (not included)
Radio.....	2-channel (not included)

Notice

All instructions, warranties and other collateral documents are subject to change at the sole discretion of Horizon Hobby, Inc. For up-to-date product literature, visit <http://www.horizonhobby.com> and click on the support tab for this product.

Meaning of Special Language

The following terms are used throughout the product literature to indicate various levels of potential harm when operating this product:

NOTICE: Procedures, which if not properly followed, create a possibility of physical property damage AND a little or no possibility of injury.

CAUTION: Procedures, which if not properly followed, create the probability of physical property damage AND a possibility of serious injury.

WARNING: Procedures, which if not properly followed, create the probability of property damage, collateral damage, and serious injury OR create a high probability of superficial injury.

 **WARNING**: Read the ENTIRE instruction manual to become familiar with the features of the product before operating. Failure to operate the product correctly can result in damage to the product, personal property and cause serious injury.

This is a sophisticated hobby product and NOT a toy. It must be operated with caution and common sense and requires some basic mechanical ability. Failure to operate this Product in a safe and responsible manner could result in injury or damage to the product or other property. This product is not intended for use by children without direct adult supervision. Do not attempt disassemble, use with incompatible components or augment product in any way without the approval of Horizon Hobby, Inc. This manual contains instructions for safety, operation and maintenance. It is essential to read and follow all the instructions and warnings in the manual, prior to assembly, setup or use, in order to operate correctly and avoid damage or serious injury.

Table of Contents

Notice	2
Meaning of Special Language	2
Table of Contents	2
Recommended Tools and Adhesives	3
Recommended Radio Equipment and Batteries	3
General Guidelines and Safety Precautions	3
Basic Assembly	4
Handling Adjustments	6
Maintenance	8
Warranty and Repair Policy	11
Warranty Services	12-13
Compliance Information for the European Union	14
Replacement Parts	15

Recommended Tools and Adhesives

- Needle nose pliers
- Marine grease (PRB0100 or PRB0101)
- Paper towel
- Rubbing alcohol
- Open end wrench: 7mm, 8mm
- Phillips screwdriver: #1
- Hex wrench: 1.5mm, 3mm
- Clear tape (PRB0102)

Recommended Radio Equipment and Batteries

You will need a 2-channel transmitter. We recommend one of the crystal-free, interference-free Spektrum™, Pro Boat® or JR® radio systems using DSM marine technology.

Spektrum Marine compatible transmitters:

- DX3E (SPM3160)
- DX2.0 (SPM20220)
- DX3.0 (SPM20320)
- DX2S (SPM2120)
- DX3S (SPM3140)
- Pro Boat Pistol Grip 2.4GHz (PRB8060)
- Spektrum and JR DSM2™ aircraft transmitters

www.spektrumrc.com

Batteries

In addition, we recommend the purchase of one of the following batteries:

- PRB3316 7.2V 5100mAh Ni-MH with Deans Connector
- DYN5351D 7.4V 3200mAh 25C Li-Po with Deans Connector
- DYN5352D 7.4V 4200mAh 25C Li-Po with Deans Connector
- DYN5360D 7.4V 5300mAh 25C Li-Po with Deans Connector
- DYN5361D 7.4V 6000mAh 25C Li-Po with Deans Connector

www.dynamiterc.com

General Guidelines and Safety Precautions

It is important that you read and follow this instruction manual, along with the radio system manual before you run this exciting boat. Failure to read and understand the manual could result in personal injury, property damage or permanent damage to your boat. It is also important to run your boat responsibly. With proper care and maintenance, you will be able to proudly enjoy your Stiletto for many years to come.

When operating the boat, stay clear of people, full-scale boats, stationary objects and wildlife. It is preferable to operate the Stiletto in low wake, low wind conditions and in areas free of people, wildlife and objects.

Check all of the hardware, and the propeller, for damage and loose screws before and after each run.

If at any time while operating your model you sense any abnormal function, end your operation immediately. Do not operate your boat again until you are certain the problem has been corrected. ***Always stay clear of the propeller.***

The Spektrum trademark is used with permission of Bachmann Industries, Inc.

Basic Assembly

Required Equipment and Accessories

Transmitter with batteries
Motor batteries (charged)
Hook and loop tape

- 1. Locate the pieces for the boat stand. The longer side pieces will key to the shorter end pieces. Use a small amount of Medium CA to glue the pieces together.

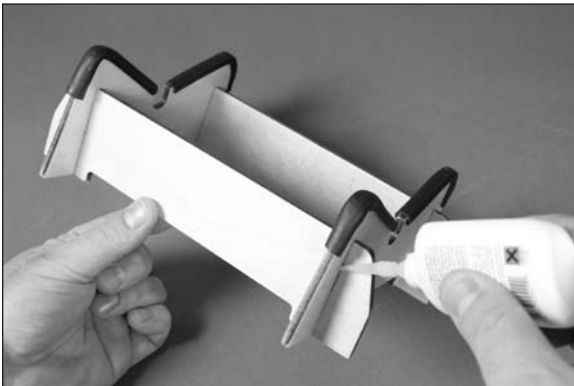

- 2. Loosen the fittings securing the hatch to the hull. Pull the rear of the hatch away from the hull slightly and then forward to remove it from the hull.



- 3. Remove the clear battery cover from the hull. Place the motor batteries in the hull. The rear battery fits under the speed control, and the forward battery lays flat in the radio compartment. This keeps the center of gravity low for the best handling of your model. Use the hook and loop tape supplied with your model to keep the batteries from moving in the hull.



Note: Make sure to center the trims for both the steering and throttle on your transmitter.

- 4. Move the switch on the transmitter to the ON position. Connect the batteries to the battery plugs from the speed control.

Be sure to use a PRB3311 Programming module to adjust the cutoff voltage when using Li-Po batteries to protect against over discharging the batteries.

The programming module offers other beneficial adjustments like exponential throttle curves, and timing adjustments. Visit ProBoatModels.com and search "Programming Module" for further details.



Note: It is recommended to bind the receiver to the transmitter at this time. Follow the instructions provided with your radio system for this procedure. Stay clear of the propeller in case the motor begins to operate unexpectedly.

- 5. Place the clear battery cover back into position. We suggest using clear tape around the edge of the cover to keep water from entering the battery compartment.



- 6. Check the operation of the steering in relationship to the steering wheel. When the wheel is rotated clockwise, the outboard motor must move right as shown. If not, follow the instructions from the radio to set the servo reversing for the steering.

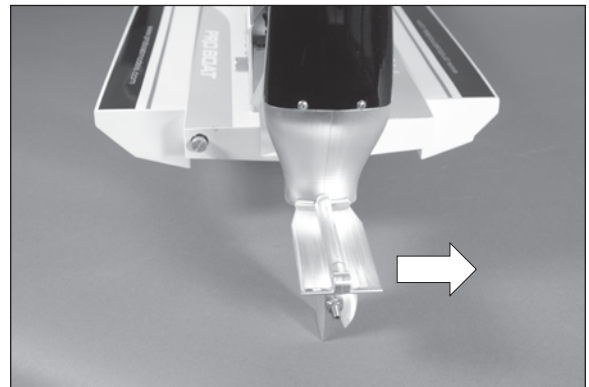

- 7. Check the operation of the propeller in relationship to the throttle trigger. When the trigger is pulled in, the propeller must rotate counterclockwise as shown. If not, follow the instructions from the radio to set the servo reversing for the throttle. The recommended amount of steering response for initial setup is 30mm left and right from center as measured from the rear of the skeg (lowest part of the outboard).

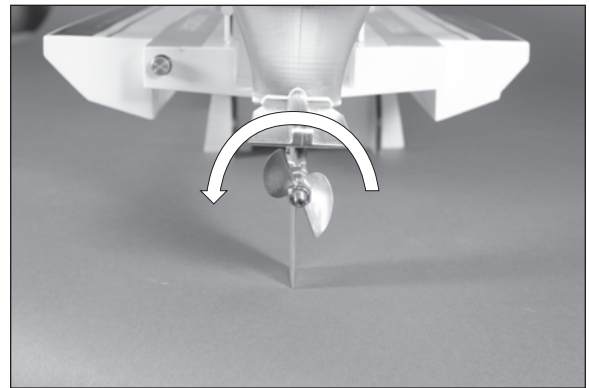
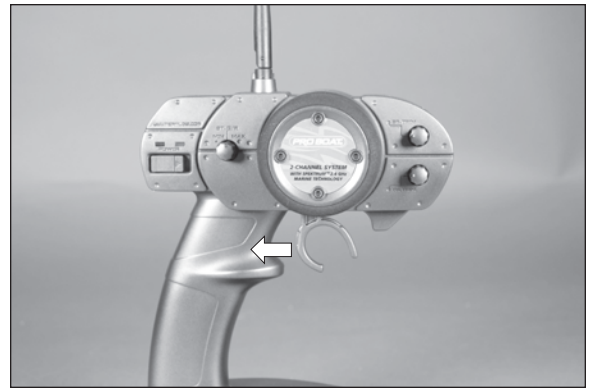

Handling Adjustments

There are several adjustments necessary to getting the best handling characteristics from the Stiletto. Begin your first run with the batteries centered in the radio box, the motor height centered and the trim angle set slightly upwards.

Trim

Up Trim (lifting the rear of the outboard) will raise the bow of the boat out of the water and have the least resistance in the water but excessive adjustments can cause cavitation and porpoising.

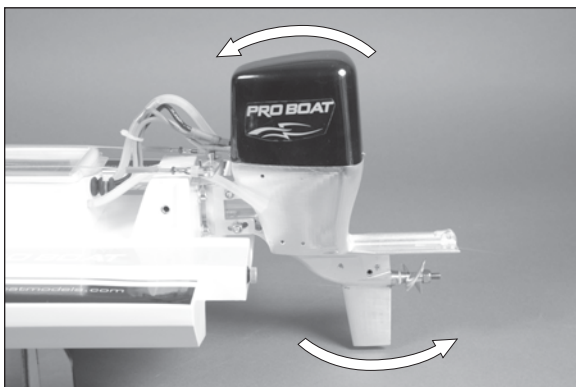

Down Trim (lowering the rear of the outboard) will make the boat more stable in rougher water and eliminate porpoising but may cause the boat to spin out while turning.

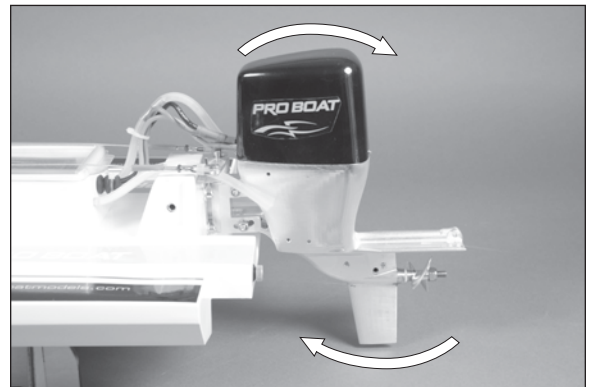

Use a 3mm hex wrench and 7mm open end wrench to loosen the two bolts that attach the motor to the mount to adjust the trim.



Use a 3mm hex wrench to loosen the four bolts that attach the motor mount to the hull to adjust the height.



Finding the proper trim angle will allow the boat to turn correctly without sacrificing high-end performance.

Outboard Height

Lowering the outboard will increase steering response but excessive lowering can increase resistance that can decrease top speeds.

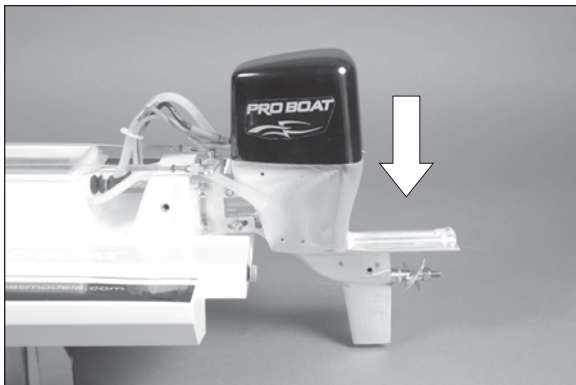

Excessively raising the outboard can cause hooking and lessen the ability to turn. This can also cause cavitation.

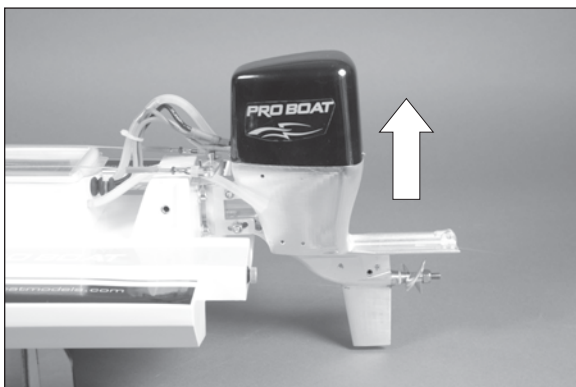

Center of Gravity

Moving the batteries to the front or back can significantly affect the boat's performance. Move the batteries toward the rear of the boat to raise the front of the hull out of the water for increased speed.

Move the batteries to the front of the boat for faster initial acceleration, to eliminate porpoising and increase stability.



Maintenance

Required Tools and Lubricants

Needle nose pliers
Marine grease
Paper towel
Rubbing alcohol
Open end wrench: 7mm, 8mm
Phillips screwdriver: #1
Hex wrench: 1.5mm, 3mm

Checking the Steering Cables

It will be necessary to check the steering cables to make sure they have not stretched over time. Loose cables may cause your boat to wander right and left and make it difficult to trim.

- 1. Check the steering cables, making sure they are tight and the steering is slop-free. Use needle nose pliers to tighten the nuts against the clevis to keep the cables from vibrating loose.



Lubricating the Flex Shaft

Lubricating the drive system is vital to the life of the drivetrain. The lubricant also acts as a water seal, keeping water from entering the hull through the stuffing box.

Lubricate the drive shaft, propeller shaft and all moving parts after every 2–3 hours of operation.

- 1. Use a thin 8mm open end wrench to remove the brass ferrule from the lower end of the motor.

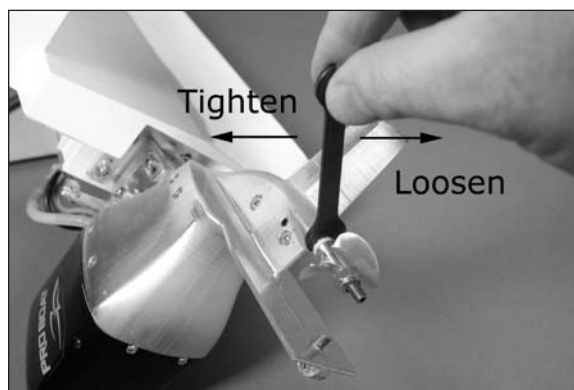

Note: The threads on the brass ferrule are reverse threaded. Make sure to review the photo before removing the ferrule.

- 2. Carefully remove the brass ferrule from the lower end.

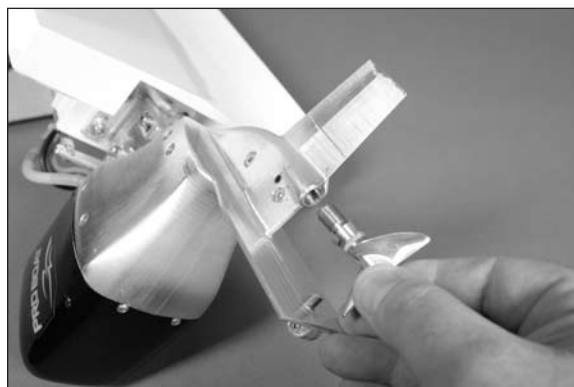

- 3. Use needle nose pliers to grab the flex shaft, removing it from the lower end.

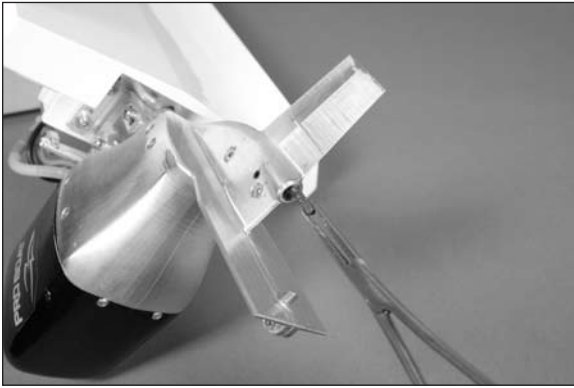

- 4. Use a paper towel and rubbing alcohol to clean the flex shaft.



- 5. Apply a waterproof marine grease to the flex shaft. We recommend the Pro Boat marine grease available at your local hobby dealer.

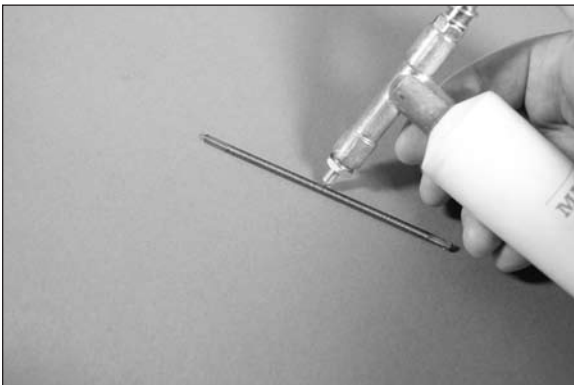

- 6. Apply a small amount of Pro Boat Marine grease (PRB0100) through the small hole in the brass ferrule to lubricate the propeller shaft.

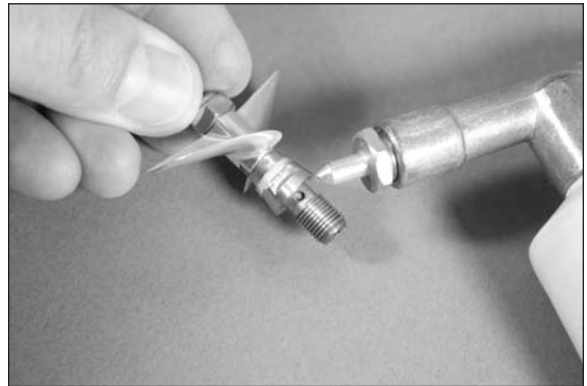

- 7. Reverse the previous steps to reassemble the flex drive in the motor. You will need to rotate the parts slightly so they key back together correctly during assembly.

Removing the Motor Cover

The cooling lines are located under the motor cover. If you find water is not flowing through the lines, you will need to remove the motor cover and check the lines for blockage.

- 1. There are four screws on the motor cover you will need to remove to access the motor and cooling tubes.



Checking the Steering Setscrews

It may be necessary to tighten the setscrews attaching the steering arm and shaft to the motor mount if your boat is proving difficult to trim or the steering is sloppy. To access the setscrews you will need to remove the motor from the mount.

- 1. Use a 3mm hex wrench and 7mm open end wrench to remove the two bolts that attach the motor to the mount.

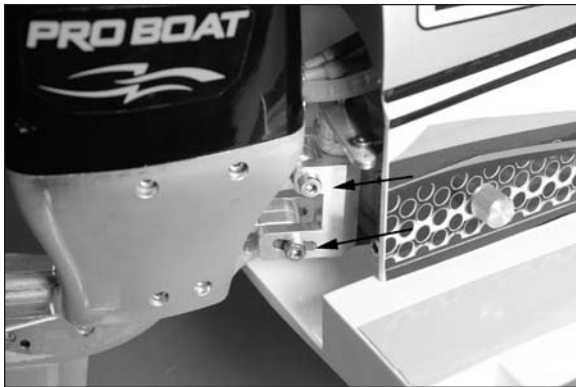

- 2. Use a 1.5mm hex wrench to tighten the setscrews securing the motor mount to the steering shaft. Use threadlock on the setscrews to prevent them from vibrating loose.



- 3. Use a 1.5mm hex wrench to tighten the setscrew securing the steering arm to the steering shaft. Use threadlock on the setscrew to prevent it from vibrating loose.

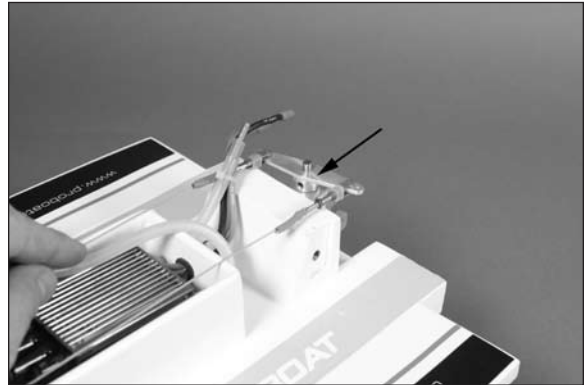

Warranty and Repair Policy

Warranty Period

Exclusive Warranty- Horizon Hobby, Inc., (Horizon) warrants that the Products purchased (the "Product") will be free from defects in materials and workmanship at the date of purchase by the Purchaser.

Limited Warranty

Horizon reserves the right to change or modify this warranty without notice and disclaims all other warranties, express or implied.

(a) This warranty is limited to the original Purchaser ("Purchaser") and is not transferable. REPAIR OR REPLACEMENT AS PROVIDED UNDER THIS WARRANTY IS THE EXCLUSIVE REMEDY OF THE PURCHASER. This warranty covers only those Products purchased from an authorized Horizon dealer. Third party transactions are not covered by this warranty. Proof of purchase is required for warranty claims.

(b) Limitations- HORIZON MAKES NO WARRANTY OR REPRESENTATION, EXPRESS OR IMPLIED, ABOUT NON-INFRINGEMENT, MERCHANTABILITY OR FITNESS FOR A PARTICULAR PURPOSE OF THE PRODUCT. THE PURCHASER ACKNOWLEDGES THAT THEY ALONE HAVE DETERMINED THAT THE PRODUCT WILL SUITABLY MEET THE REQUIREMENTS OF THE PURCHASER'S INTENDED USE.

(c) Purchaser Remedy- Horizon's sole obligation hereunder shall be that Horizon will, at its option, (i) repair or (ii) replace, any Product determined by Horizon to be defective. In the event of a defect, these are the Purchaser's exclusive remedies. Horizon reserves the right to inspect any and all equipment involved in a warranty claim. Repair or replacement decisions are at the sole discretion of Horizon. This warranty does not cover cosmetic damage or damage due to acts of God, accident, misuse, abuse, negligence, commercial use, or modification of or to any part of the Product. This warranty does not cover damage due to improper installation, operation, maintenance, or attempted repair by anyone other than Horizon. Return of any goods by Purchaser must be approved in writing by Horizon before shipment.

Damage Limits

HORIZON SHALL NOT BE LIABLE FOR SPECIAL, INDIRECT OR CONSEQUENTIAL DAMAGES, LOSS OF PROFITS OR PRODUCTION OR COMMERCIAL LOSS IN ANY WAY CONNECTED WITH THE PRODUCT, WHETHER SUCH CLAIM IS BASED IN CONTRACT, WARRANTY, NEGLIGENCE, OR STRICT LIABILITY. Further, in no event shall the liability of Horizon exceed the individual price of the Product on which liability is asserted. As Horizon has no control over use, setup, final assembly, modification or misuse, no liability shall be assumed nor accepted for any resulting damage or injury. By the act of use, setup or assembly, the user accepts all resulting liability.

If you as the Purchaser or user are not prepared to accept the liability associated with the use of this Product, you are advised to return this Product immediately in new and unused condition to the place of purchase.

Law: These Terms are governed by Illinois law (without regard to conflict of law principals).

Warranty Services

Questions, Assistance, and Repairs

Your local hobby store and/or place of purchase cannot provide warranty support or repair. Once assembly, setup or use of the Product has been started, you must contact Horizon directly. This will enable Horizon to better answer your questions and service you in the event that you may need any assistance. For questions or assistance, please direct your email to productsupport@horizonhobby.com, or call 877.504.0233 toll free to speak to a service technician.

Inspection or Repairs

If this Product needs to be inspected or repaired, please call for a Return Merchandise Authorization (RMA). Pack the Product securely using a shipping carton. Please note that original boxes may be included, but are not designed to withstand the rigors of shipping without additional protection. Ship via a carrier that provides tracking and insurance for lost or damaged parcels, as Horizon is not responsible for merchandise until it arrives and is accepted at our facility. A Service Repair Request is available at www.horizonhobby.com on the "Support" tab. If you do not have internet access, please include a letter with your complete name, street address, email address and phone number where you can be reached during business days, your RMA number, a list of the included items, method of payment for any non-warranty expenses and a brief summary of the problem. Your original sales receipt must also be included for warranty consideration. Be sure your name, address, and RMA number are clearly written on the outside of the shipping carton.

Warranty Inspection and Repairs

To receive warranty service, you must include your original sales receipt verifying the proof-of-purchase date. Provided warranty conditions have been met, your Product will be repaired or replaced free of charge. Repair or replacement decisions are at the sole discretion of Horizon Hobby.

Warranty Services

Non-Warranty Repairs

Should your repair not be covered by warranty the repair will be completed and payment will be required without notification or estimate of the expense unless the expense exceeds 50% of the retail purchase cost. By submitting the item for repair you are agreeing to payment of the repair without notification. Repair estimates are available upon request. You must include this request with your repair. Non-warranty repair estimates will be billed a minimum of 1/2 hour of labor. In addition you will be billed for return freight. Please advise us of your preferred method of payment. Horizon accepts money orders and cashiers checks, as well as Visa, MasterCard, American Express, and Discover cards. If you choose to pay by credit card, please include your credit card number and expiration date. Any repair left unpaid or unclaimed after 90 days will be considered abandoned and will be disposed of accordingly. Please note: non-warranty repair is only available on electronics and model engines.

United States

(Electronics and engines)

Horizon Service Center
4105 Fieldstone Rd
Champaign, Illinois
61822 USA
productsupport@horizonhobby.com
877-504-0233

(All other products)

Horizon Product Support
4105 Fieldstone Rd
Champaign, Illinois
61822 USA
productsupport@horizonhobby.com
877-504-0233

United Kingdom

Horizon Hobby Limited
Units 1-4 Ployters Rd
Staple Tye
Harlow, Essex
CM18 7NS
United Kingdom
sales@horizonhobby.co.uk
+44 (0) 1279 641 097

Germany

Horizon Technischer Service
Hamburger Str. 10
25335 Elmshorn
Germany
service@horizonhobby.de
+49 4121 46199 66

France

Horizon Hobby SAS
14 Rue Gustave Eiffel
Zone d'Activité du Réveil Matin
91230 Montgeron
+33 (0) 1 60 47 44 70

Compliance Information for the European Union



Declaration of Conformity

(in accordance with
ISO/IEC 17050-1)

No. HH2010052002

Product(s): Pro Boat Stiletto
BindNDrive

Item Number(s): PRB4000BD

Equipment class: 1

The object of declaration described above is in conformity with the requirements of the specifications listed below, following the provisions of the European R&TTE directive 1999/5/EC:

EN 301 489-1, 301 489-17 General EMC requirements

Signed for and on behalf of:

Horizon Hobby, Inc.
Champaign, IL USA
May 20, 2010

Steven A. Hall

Vice President

International Operations and Risk
Management

Horizon Hobby, Inc.



Instructions for Disposal of WEEE by Users in the European Union

This product must not be disposed of with other waste. Instead, it is the user's responsibility to dispose of their waste equipment by handing it over to a designated collection point for the recycling of waste electrical and electronic equipment. The separate collection and recycling of your waste equipment at the time of disposal will help to conserve natural resources and ensure that it is recycled in a manner that protects human health and the environment. For more information about where you can drop off your waste equipment for recycling, please contact your local city office, your household waste disposal service or where you purchased the product.

Replacement Parts

Go to ProBoatModels.com to see photos of the replacement parts listed under Stiletto. If you have any questions concerning the setup or running of your model, please see page 14 to contact the appropriate Horizon service center.

Main Components

PRB4001	Hull only
PRB4002	Cowl
PRB4003	Boat Stand
PRB4004	Drain Plug (2)
PRB4005	Cowl Screw
PRB4006	Outboard Mounting Screw (4)
PRB4007	Steering Set
PRB4008	Silicone Tubing
PRB4009	Radio Box Cover
PRB4010	Battery Cover
PRB4011	Switch Mount
PRB4012	Antenna Tube
PRB4013	Servo Wheel
PRB4014	Bellows (5)

Outboard and Power system

PRB4016	Outboard Hood
PRB4017	A3630-1800Kv Water-cooled Motor
PRB4018	60-amp Brushless ESC
PRB4019	Stainless Propeller
PRB4020	Outboard without Motor
PRB4021	Steering Mount
PRB4022	Pivot Mount
PRB4023	Control Horn
PRB4024	Outboard Case (left)
PRB4025	Outboard Case (right)
PRB4026	Motor Mount
PRB4027	Brass Ferrule
PRB4028	Stub Shaft
PRB4029	Drive Dog
PRB4030	Motor Coupler
PRB4031	Water Pickup
PRB4032	Pivot Shaft
PRB4033	Flexshaft
PRB4034	Nylon Bushing
PRB4035	Screw Set
PRB4036	Flexshaft Liner
PRB4037	Shear Pin

PRO BOAT®

HORIZON
H O B B Y

© 2010 Horizon Hobby, Inc.
horizonhobby.com
www.proboatmodels.com