 <p>VTR235113</p>	<p>x 10 M3 x 25mm Button Head Screw M3 x 25mm Halbrundsrauben Vis à tête bombée M3 x 25mm Viti testa tonda M3 x 25mm</p>
 <p>VTR235112</p>	<p>x 10 M3 x 20mm Button Head Screw M3 x 20mm Halbrundsrauben Vis à tête bombée M3 x 20mm Viti testa tonda M3 x 20mm</p>
 <p>VTR235110</p>	<p>x 10 3mm x 16mm Button Head Screw 3mm x 16mm Halbrundsrauben Vis à tête bombée 3mm x 16mm Viti testa tonda 3mm x 16mm</p>
 <p>VTR235109</p>	<p>x 10 3mm x 14mm Button Head Screw 3mm x 14mm Halbrundsrauben Vis à tête bombée 3mm x 14mm Viti testa tonda 3mm x 14mm</p>
 <p>VTR235107</p>	<p>x 10 3mm x 10mm Button Head Screw 3mm x 10mm Halbrundsrauben Vis à tête bombée 3mm x 10mm Viti testa tonda 3mm x 10mm</p>
 <p>VTR235106</p>	<p>x 10 M3 x 8mm Button Head Screw M3 x 8mm Halbrundsrauben Vis à tête bombée M3 x 8mm Viti testa tonda M3 x 8mm</p>
 <p>VTR235105</p>	<p>x 10 M3 x 6mm Button Head Screw M3 x 6mm Halbrundsrauben Vis à tête bombée M3 x 6mm Viti testa tonda M3 x 6mm</p>

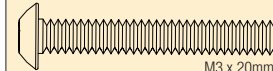

x 10

M2.5 x 20mm Button Head Screw  
M2,5 x 20mm Halbrundschräuben  
Vis à tête bombée M2,5 x 20mm  
Viti testa tonda M2,5 x 20mm

VTR235102

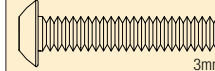
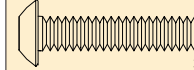
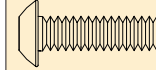
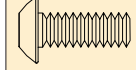
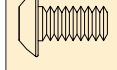
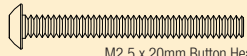

x 10

M2 x 6mm Cap Head Screw  
M2 x 6mm Innensechskantschrauben  
Vis à tête creuse M2 x 6mm  
Viti a testa bombata M2 x 6mm

VTR235003

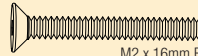

x 10

M2 x 16mm Flat Head Screw  
M2 x 16mm Flachkopfschrauben  
Vis à tête fraisée M2 x 16mm  
Viti a testa piatta M2 x 16mm

VTR235162



x 10

M3 Nylock Flanged Nut  
M3 Muttern Nylock angeflanscht  
Ecrou Nylock bride M3  
Dado Nylock flangiato M3

VTR236024

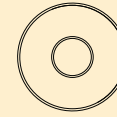

VTR237009

x 2

5mm x 13mm x 4mm Ball Bearing  
5mm x 13mm x 4mm Kugellager  
Roulement 5mm x 13mm x 4mm  
Cuscinetto a sfere 5mm x 13mm x 4mm

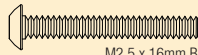

x 10

M2.5 x 16mm Button Head Screw  
M2,5 x 16mm Halbrundschräuben  
Vis à tête bombée M2,5 x 16mm  
Viti testa tonda M2,5 x 16mm

VTR235101

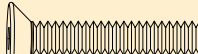

x 10

M3 x 16mm Flat Head Screw  
M3 x 16mm Flachkopfschrauben  
Vis à tête fraisée M3 x 16mm  
Viti a testa piatta M3 x 16mm

VTR235179

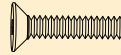

x 10

M2 x 10mm Flat Head Screw  
M2 x 10mm Flachkopfschrauben  
Vis à tête fraisée M2 x 10mm  
Viti a testa piatta M2 x 10mm

VTR235160



x 10

M3 Nylock Nut  
M3 Muttern Nylock  
Ecrou Nylock M3  
Dado Nylock M3

VTR236014



VTR237003

x 2

4mm x 8mm x 3mm Ball Bearing  
5mm x 10mm x 4mm Kugellager  
Roulement 5mm x 10mm x 4mm  
Cuscinetto a sfere 5mm x 10mm x 4mm

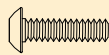

x 10

M2.5 x 8mm Button Head Screw  
M2,5 x 8mm Halbrundschräuben  
Vis à tête bombée M2,5 x 8mm  
Viti testa tonda M2,5 x 8mm

VTR235098



x 10

M3 x 14mm Flat Head Screw  
M3 x 14mm Flachkopfschrauben  
Vis à tête fraisée M3 x 14mm  
Viti a testa piatta M3 x 14mm

VTR235178



x 10

M3 x 12 Flat Head Hinge Pin Screw  
Schraube Querlenkerstift M3 x12  
Vis/axe à tête plate M3x12mm  
M3 X 12 Vide a taglio

VTR235224



x 10

M2.5 Nylock Nut  
M2,5 Muttern Nylock  
Ecrou Nylock M2,5  
Dado Nylock M2,5

VTR236013

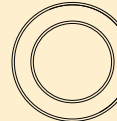

VTR237028

x 2

10mm x 15mm x 4mm Nylon Retainer Ball Bearing  
Kunststoffkugellager 10mm x 15mm x 4mm  
Roulement à cage à billes en nylon 10 x 15 x 4mm  
Cuscinetti con ritenuta in nylon 10mm x 15mm x 4mm



x 10

M2.5 x 6mm Button Head Screw  
M2,5 x 6mm Halbrundschräuben  
Vis à tête bombée M2,5 x 6mm  
Viti testa tonda M2,5 x 6mm

VTR235097

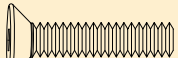

x 10

M3 x 12mm Flat Head Screw  
M3 x 12mm Flachkopfschrauben  
Vis à tête fraisée M3 x 12mm  
Viti a testa piatta M3 x 12mm

VTR235177



x 10

M3 x 3mm Cup Point Set Screw  
M3 x 3mm Ringschneide Gewindestift  
Vis Imbus à bout cuvette M3 x 3mm  
Tazza punto grani M3 x 3mm

VTR235320



x 10

M2 Nylock Nut  
M2 Muttern Nylock  
Ecrou Nylock M2  
Dado Nylock M2

VTR236012

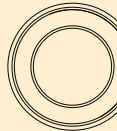

VTR237028

x 2

10mm x 15mm x 4mm Flanged Ball Bearing  
10mm x 15mm x 4mm Bundlager  
Roulement bride 10 x 15 x 4mm  
Cuscinetti flangiato 10mm x 15mm x 4mm



x 10

M2 x 6mm Button Head Screw  
M2 x 6mm Halbrundschräuben  
Vis à tête bombée M2 x 6mm  
Viti testa tonda M2 x 6mm

VTR235088

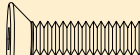

x 10

M3 x 10mm Flat Head Screw  
M3 x 10mm Flachkopfschrauben  
Vis à tête fraisée M3 x 10mm  
Viti a testa piatta M3 x 10mm

VTR235176



x 10

3mm E-Clip  
3mm E-Clip  
E-Clip 3mm  
E-Clip 3mm

VTR236131



x 10

M3 Flat Nut  
M3 Flachmutter  
Ecrou plat M3  
Dado piatto M3

VTR236002

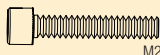

x 10

M2 x 12mm Cap Head Screw  
M2 x 12mm Innensechskantschrauben  
Vis à tête creuse M2 x 12mm  
Viti a testa bombata M2 x 12mm

VTR235006

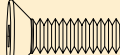

x 10

M3 x 8mm Flat Head Screw  
M3 x 8mm Flachkopfschrauben  
Vis à tête fraisée M3 x 8mm  
Viti a testa piatta M3 x 8mm

VTR235175



x 10

3.2mm x 7mm x .5mm Washer  
3,2mm x 7mm x ,5mm Unterlegscheiben  
Rondelle 3,2mm x 7mm x ,5mm  
Rondella 3,2mm x 7mm x ,5mm

VTR236076



VTR237004

x 2

5mm x 10mm x 4mm Ball Bearing  
5mm x 10mm x 4mm Kugellager  
Roulement 5mm x 10mm x 4mm  
Cuscinetto a sfere 5mm x 10mm x 4mm

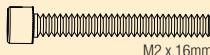

x 10

M2 x 16mm Cap Head Screw  
M2 x 6mm Innensechskantschrauben  
Vis à tête creuse M2 x 6mm  
Viti a testa bombata M2 x 6mm

VTR235008

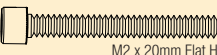

x 10

M2 x 20mm Flat Head Screw  
M2 x 20mm Flachkopfschrauben  
Vis à tête fraisée M2 x 20mm  
Viti a testa piatta M2 x 20mm

VTR235009



x 10

M4 Nylock Flanged Nut  
M4 Muttern Nylock angeflanscht  
Ecrou Nylock bride M4  
Dado Nylock flangiato M4

VTR236025



VTR237007

x 2

5mm x 11mm x 4mm Ball Bearing  
5mm x 11mm x 4mm Kugellager  
Roulement 5mm x 11mm x 4mm  
Cuscinetto a sfere 5mm x 11mm x 4mm

## REPLACEMENT PARTS // ERSATZTEILE // PIÈCES DE RECHANGE // PEZZI DI RICAMBIO //

Part #   Nummer Numéro   Codice	Description	Beschreibung	Description	Descrizione
DYN4114	10W Li-Po AC Balance Charger	Dynamite 10W LiPo Balance Ladegerät	Chargeur AC équilibreur Li-Po 10W	Caricatore Li-Po AC 10W con bilanciamento
DYN1172	Dynamite 15-Turn Brushed Motor	Dynamite 15 Turn Bürstenmotor	Moteur Dynamite 15T à balais	Motore Dynamite 15-Spire Brushed
DYNS2210WP	60A FWD/REV Brushed ESC	60A Vorw./Rückw. Bürstenregler	Contrôleur Brushed 60A Marche avant/Arrière	Ecroû autofreiné M3 (10)
DYN1476	Dynamite 7.4V 2000mAh 2S 30C Li-Po Long	Dynamite 7.4V 2000mAh 2S 30C Li-Po Lang	Batterie Li-Po Dynamite 2S 7.4V 2000mA 30C	Batteria Li-Po Dynamite 7.4V 2000mAh 2S 30C lunga
SPMSR300WP	Waterproof Surface Receiver	Spektrum Spritzwassergeschützter Surface Empfänger	Récepteur étanche	Ricevitore impermeabile
SPM2325	DX2E 2-Channel DSMR Surface Transmitter with SR310	DX2E 2-Channel DSMR Surface Sender mit SR310	Émetteur DX2E 2 voies avec SR310	DX2E trasmittente a 2 canali DSMR con SR310
SPMS605	9kg Servo, WP, Metal, 23T	Spektrum S605 9KG WP-Metall-Servo 23T	Servo 9Kg à pignons métal, étanche, tête 23T	Servo con ingranaggio in metallo 9kg, resistente all'acqua, 23T

## TIRE & WHEEL // REIFEN UND RAD // PNEU AVEC JANTE // GOMME E CERCHI //

Part #   Nummer Numéro   Codice	Description	Beschreibung	Description	Descrizione
VTR43000	Beadlock Wheel with Rings (2)	Vaterra Beadlockfelgen und Ringe (2)	Jantes Beadlock avec anneaux (2)	Ruote Beadlock con anelli (2)
VTR43001	1.9" Race Claw Tire with Insert (2)	Vaterra 1.9" Race Claw Reifen inkl. Einlage (2)	Pneus Race Claw 1.9 avec inserts (2)	Gomme 1.9" Race Claw con inserti (2)



# FRONT/REAR DIFFERENTIAL // FRONT/HECK DIFFERENTIAL // DIFFÉRENTIEL AVANT/ARRIÈRE ////////////////////////////////////// DIFFERENZIALE ANTERIORE/POSTERIORE

Part #   Nummer Numéro   Codice	Description	Beschreibung	Description	Descrizione
VTR232005	Front Outdrives (2)	Vaterra Antriebsklauen Vorne (2)	Noix de cardan avant (2)	Trascinatori anteriori (2)
VTR232015	Fr/R Diff Housing	Vaterra Diffgehäuse Vorne/Hinten	Carter de différentiel av/arr	Sede diff. anter./poster
VTR232016	Fr/R Ring & Pinion Gear	Vaterra Tellerrad und Triebbling Vorne/Hinten	Couronne et pignon d'attaque de différentiel av/arr	Anello e pignone anter./poster
VTR232019	Front Diff Rebuild Kit	Vaterra Reparaturset Diff Vorne	Kit de réparation du différentiel avant	Kit diff. anter. ricostruito

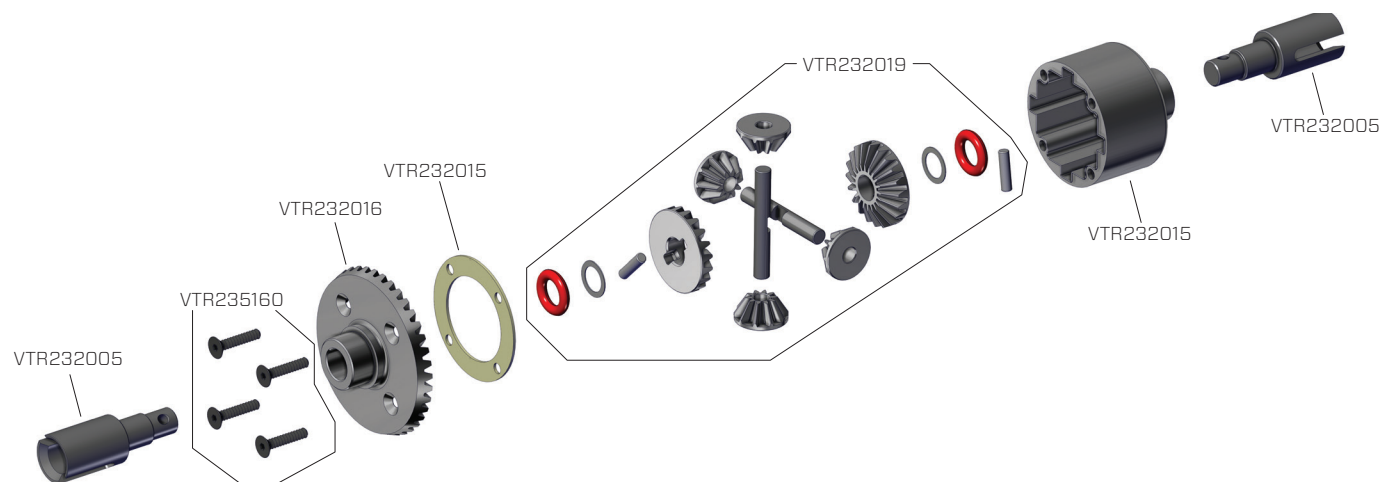

# DRIVESHAFT // WELLEN // CARDAN // TRASMISSIONE //////////////////////////////////////

Part #   Nummer Numéro   Codice	Description	Beschreibung	Description	Descrizione
VTR232011	Front Center CV Driveshaft	Vaterra CV Wellen Set Mitte	Cardan CVD central avant	Trasmissione CV centrale anter.
VTR232013	Drive Shaft Yoke, Cup & Hardware (1)	Vaterra Antriebswellenjoch (1)	Coupelle de cardan avec croisillon et visserie	Forcella, coppa e viteria semiasse (1)
VTR232021	Molded Drive Sharft	Vaterra Antriebswelle	Cardan moulé	Albero di trasmissione stampato

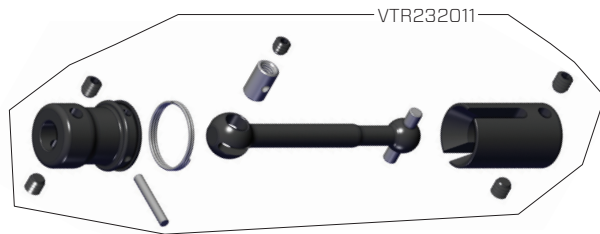

# FRONT/REAR LOCKER // VORNE/HINTEN DIFFSPERRE // CALE DE VERROUILLAGE AVANT/ARRIÈRE // ////////////////////////////////////// BLOCCAGGIO ANTERIORI/POSTERIORI

Part #   Nummer Numéro   Codice	Description	Beschreibung	Description	Descrizione
VTR232000	Transmission Molded Gear Set	Vaterra Getriebesatz	Set de pignons transmission moulés	Set ingranaggi trasmissione
VTR232001	Transmission Case	Vaterra Getriebegehäuse	Boitier de transmission	Scatola trasmissione
VTR232005	Front Outdrives (2)	Vaterra Antriebsklauen Vorne (2)	Noix de cardan avant (2)	Trascinatori anteriori (2)
VTR232014	Locker, Rear Diff	Vaterra Diffsperrre Hinten	Cale de verrouillage de différentiel arrière	Bloccaggio differenziale poster.
VTR232015	Fr/R Diff Housing	Vaterra Diffgehäuse Vorne/Hinten	Carter de différentiel av/arr	Sede diff. anter./poster
VTR232016	Fr/R Ring & Pinion Gear	Vaterra Tellerrad und Triebbling Vorne/Hinten	Couronne et pignon d'attaque de différentiel av/arr	Anello e pignone anter./poster.
VTR232019	Front Diff Rebuild Kit	Vaterra Reparaturset Diff Vorne	Kit de réparation du différentiel avant	Kit diff. anter. ricostruito
VTR332000	Locker, Front Diff	Vaterra Diffsperrre Vorne	Cale de verrouillage de différentiel avant	Bloccaggio differenziale anter.

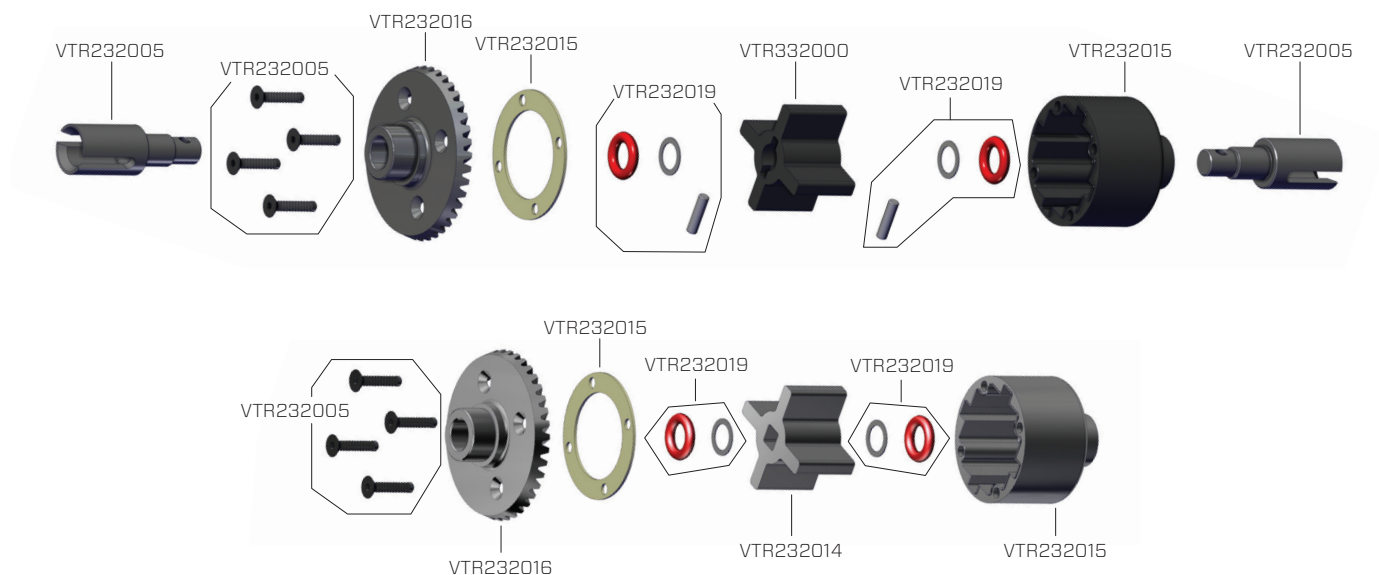

# SHOCKS // STOSSDÄMPFER // AMORTISSEUR // AMMORTIZZATORI //////////////////////////////////////

Part #   Nummer Numéro   Codice	Description	Beschreibung	Description	Descrizione
VTR232020	Spring Cup & Retainer	Vaterra Zentrierring und Federdruckplatte	Coupelle d'amortisseur avec fixation	Molla coppa e fermo
VTR233000	Shock Collar, Cap & Bushing	Vaterra Klemmring Kappe und Buchsen	Bague avec bouchon et palier d'amortisseur	Collare, tappo e boccola ammortizz.
VTR233001	Front Shock Body (2)	Vaterra Dämpfergehäuse Vorne (2)	Corps d'amortisseurs avant (2)	Corpo ammortizz. anteriore (2)
VTR233002	Shock Ends and Cups (4)	Vaterra Dämpferkappen und Kugelpfannen	Chapes et coupelles d'amortisseurs (4)	Terminali e coppe ammortizz. (4)
VTR233003	Shock Cartridge	Vaterra Dampferendkappe	Cartouche d'amortisseurs	Cartuccia ammortizz.
VTR233004	Shock Piston Set	Vaterra Kolbenplatte	Set de pistons d'amortisseurs	Set pistone ammortizz.
VTR233005	Rear Shock Shaft 1.2	Vaterra Kolbenstange Hinten	Tige d'amortisseur 1,2 arrière	Albero 1,2 ammortizz. posteriore
VTR233006	Front Shock Shaft 3.6	Vaterra Kolbenstange Vorne	Tige d'amortisseur 3,6 avant	Albero 3,6 ammortizz. anteriore
VTR233007	Rear Shock Body Set	Vaterra Dämpfergehäuseset h.	Jeu de corps d'amortisseurs arrière	Corpo ammortizzatori posteriori
VTR233012	Front Shock Spring Medium Silver (2)	Vaterra Feder v. Silber/Mittel (2)	Ressorts pour amortisseurs avant, Moyens, argent (2)	Molle anteriori medie argento (2)
VTR233023	Rear Shock Spring Soft Yellow (2)	Vaterra Feder h. Gelb/Weich (2)	Ressorts pour amortisseurs arrière, Souples, jaune (2)	Molle posteriori morbide gialle (2)
VTR234009	Rear Upper & Lower Track Rods	Vaterra Aufhängungssatz Oben/Unten	Tirants supérieurs et inférieurs arrière	Aste superiore & inferiore poster.
VTR235014	M2.5 x 10mm Cap Head Screw (10)	Vaterra M2.5 x 10mm Zylinderkopfschraube (10)	Vis BTR M2,5x10mm (10)	M2.5 x 10mm viti a brugola (10)

FRONT SHOCK // VORDERER STOSSDÄMPFER // AMORTISSEUR AVANT // AMMORTIZZATORI ANTERIORI

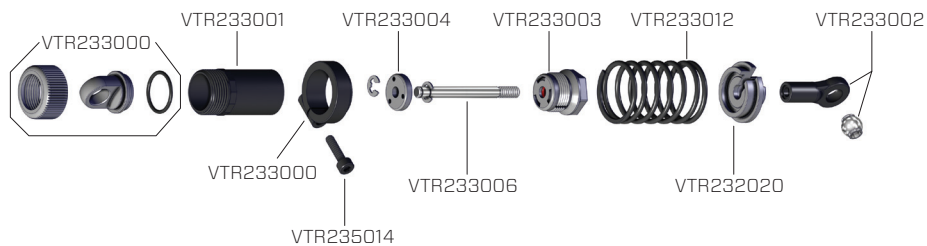

REAR SHOCK // HINTERER STOSSDÄMPFER // AMORTISSEUR ARRIÈRE // AMMORTIZZATORI POSTERIORI

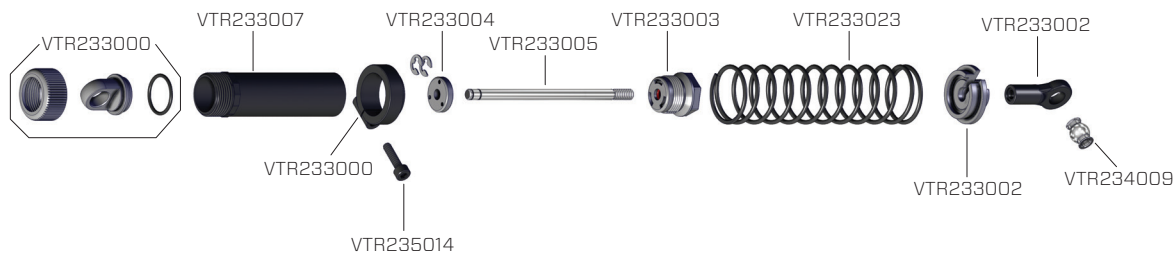



**ROLLBAR ASSEMBLY // ÜBERROLLBÜGEL // ASSEMBLAGE DE L'ARCEAU // GRUPPO ROLLBAR //**

Part #   Nummer Numéro   Codice	Description	Beschreibung	Description	Descrizione
VTR230000	Roll Cage Set	Vaterra Überrollkäfig	Arceau cage	Set roll-bar
VTR230001	Body Panel Set	Vaterra Verkleidungs Set	Jeu de panneaux de carrosserie	Set pannelli carrozzeria
VTR231004	Battery Tray & Spare Tire Mount	Vaterra Akkufach und Ersatzradhalter	Support de batterie avec support de roue de secours	Porta batteria e supporto ruota di scorta
VTR233049	Twin Hammers DT Body Set	Twin Hammers DT Karosserieset	Carrosserie Twin Hammers DT	Twin Hammers DT set carrozzeria

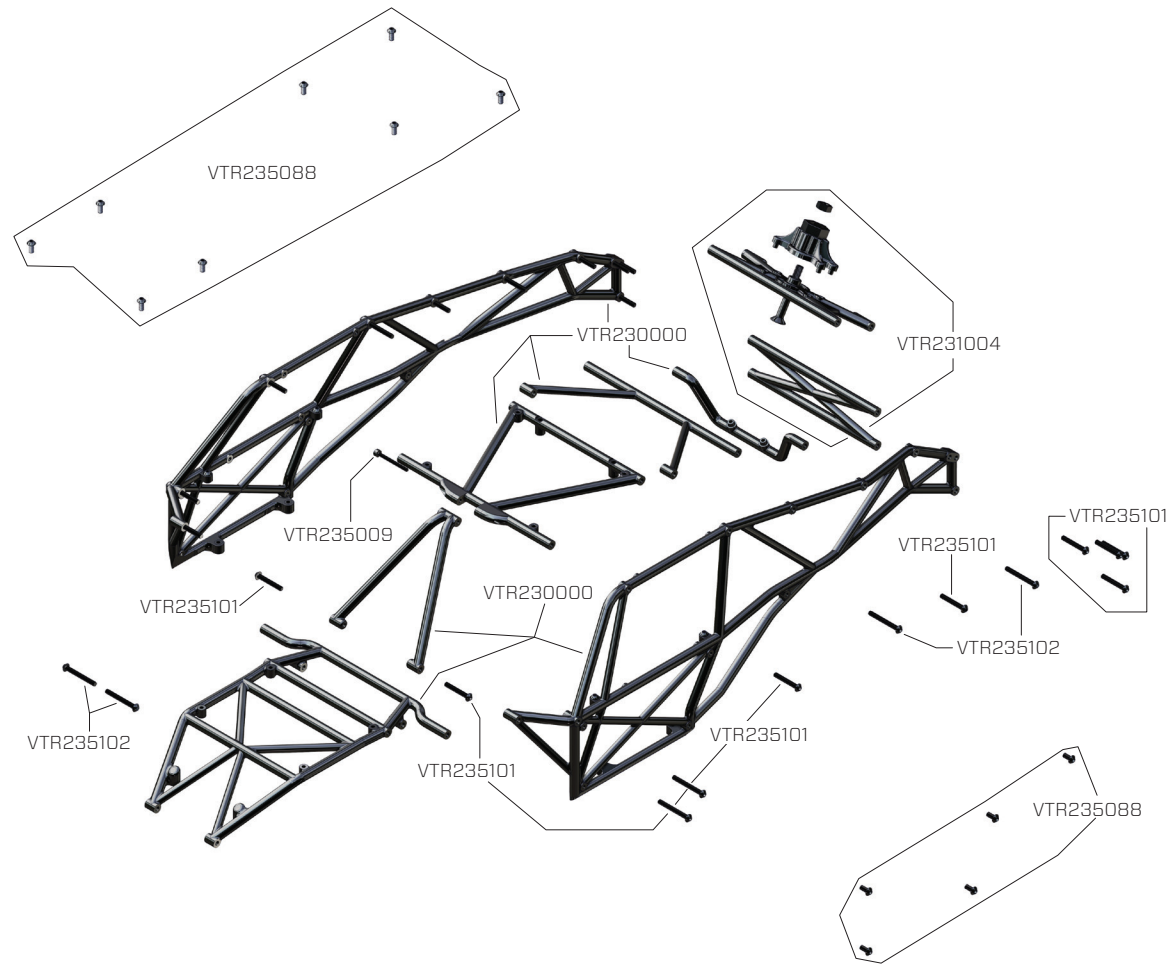

# TRANSMISSION // GETRIEBE // TRANSMISSION // TRANSMISSIONE //////////////////////////////////////

Part #   Nummer Numéro   Codice	Description	Beschreibung	Description	Descrizione
LOS4121	48 Pitch Pinion Gear, 21T	48 Motoritzel 21 Z	Pignon moteur 48DP, 21T	Pignone 48P, 21T
VTR11000	903WP Digital Servo	Vaterra 903WP Digital Servo	Servo digital 903WP	903WP servo digitale
VTR232000	Transmission Molded Gear Set	Vaterra Getriebesatz	Set de pignons transmission moulés	Set ingranaggi trasmissione
VTR232001	Transmission Case	Vaterra Getriebegehäuse	Boitier de transmission	Scatola trasmissione
VTR232006	Motor Plate & Gear Cover	Vaterra Motormontageplatte/ Abdeckung	Support moteur avec protection de transmission	Piastra motore e copertura ingran.
VTR232007	Transmission Shift Linkage Set	Vaterra Schaltgestänge Set	Tringlerie de changement de vitesse	Set collegamento trasmissione cambio
VTR232008	High & Low Speed Gear Set	Vaterra Zwei-Gang-Getriebe Set	Set de pignons petite et grande vitesse	Set ingranaggi alta e bassa velocità
VTR232009	Transmission Shift Fork & Shaft	Vaterra Schaltstangenset	Fourchette et axe de changement de vitesse	Forcella e albero trasmissione cambio
VTR232017	Transmission Shaft Set	Vaterra Antriebswellenset	Set d'arbres de transmission	Set albero trasmissione
VTR232018	Aluminum Motor Plate & Clamp	Vaterra Motorplatte und Klemmring Aluminium	Support moteur radial en aluminium	Piastra e morsetto motore in alluminio
VTR232023	Slipper Back Plate	Vaterra Rückplatte für Slipper	Plateau de slipper	Piastra posteriore slipper
VTR232024	Slipper Pads (2)	Vaterra Slipper Scheiben (2)	Garnitures de slipper (2)	Slipper Pads (2)
VTR232025	78 Tooth Spur Gear	Vaterra Hauptzahnrad 78T	Couronne 78T	Corona 78 denti
VTR232026	Slipper Spring, Cup, Spacer & Washer	Vaterra Kupplungsfeder, Distanzstück u. Unterlegscheibe	Rondelle, entretoise, ressort et coupelle de slipper	Molla, coppa, distanziale e rondella slipper
VTR235102	M2.5 x 20mm Button Head Screw (10)	Vaterra M2.5 x 20mm Rundkopf- schraube (10)	Vis à tête bombée M2,5x20mm (10)	M2.5 x 20mm viti a testa tonda (10)



# FRONT CLIP // FRONTCLIP // ASSEMBLAGE DU TRAIN AVANT // CLIP ANTERIORE //////////////////////////////////////

Part #   Nummer Numéro   Codice	Description	Beschreibung	Description	Descrizione
VTR231001	Steering Rack and Bar	Vaterra Ackermann Set	Set de guide et de barre de direction	Barre sterzo e cremagliera
VTR231003	Front Bumper	Vaterra Stoßfänger Vorne	Pare choc avant	Paraurti anteriore
VTR231014	Chassis Top Plate	Chassisabdeckung oben	Renfort avant supérieur de châssis	Coperchio superiore telaio
VTR232004	Front Center Gearbox Housing	Vaterra Getriebegehäuse Vorne	Boitier de différentiel central avant	Sede riduttore centrale anter.
VTR232005	Front Outdrives (2)	Vaterra Antriebsklauen Vorne (2)	Noix de cardan avant (2)	Trascinatori anteriori (2)
VTR232010	Front CV Shaft Set	Vaterra CV Wellen Set Vorne	Set de cardans CVD avant	Set albero CV anteriore
VTR232016	Fr/R Ring & Pinion Gear	Vaterra Tellerrad und Triebbling Vorne/Hinten	Couronne et pignon d'attaque de différentiel av/arr	Anello e pignone anter./poster.
VTR234000	Front Suspension Arms	Vaterra Querlenker Vorne	Bras de suspension avant	Bracci sospensioni anter.
VTR234001	Front Spindles	Vaterra Achsschenkel	Fusées avant	Alberini anter.
VTR234002	Front 15 Deg. Caster Blocks	Vaterra 15 Grad Träger für Achsschenkel	Etriers portes fusées avant 15°	Blocchi anter. caster 15°
VTR234003	Front Hinge Pin Brace and Cap	Vaterra Querlenkerhalter Vorne inkl. Kappen	Renfort de cellule avant avec protection	Supporto perno cerniera e tappo
VTR234004	Front Rocker Arm Set	Vaterra Schwingenset	Set de basculeurs avant	Set braccio bilanciante anter.
VTR234005	Front Tie Rod Set	Vaterra Aufhängungsset	Set de tirants avant	Set stelo e fascetta anter.
VTR234006	Front Captured Rod End 6mm (6)	Vaterra Kugelpfannen Vorne 6mm (6)	Chapes rotules fermées avant 6mm (6)	Terminale asta anter. 6mm (6)
VTR234007	Pushrod Pivot Balls & Pins	Vaterra Kugelkopf und Stifte	Goupilles et articulations de tringleries	Cardine, sfere e perni astine comandi
VTR234010	Front Inner Hinge Pin (2)	Vaterra Querlenkerstift Vorne/Innen (2)	Axes de suspension avant intérieurs (2)	Perno cerniera interiore anter. (2)
VTR234012	Ball Cup Ends	Vaterra Kugelpfannen	Chapes rotules	Attacchi a sfera

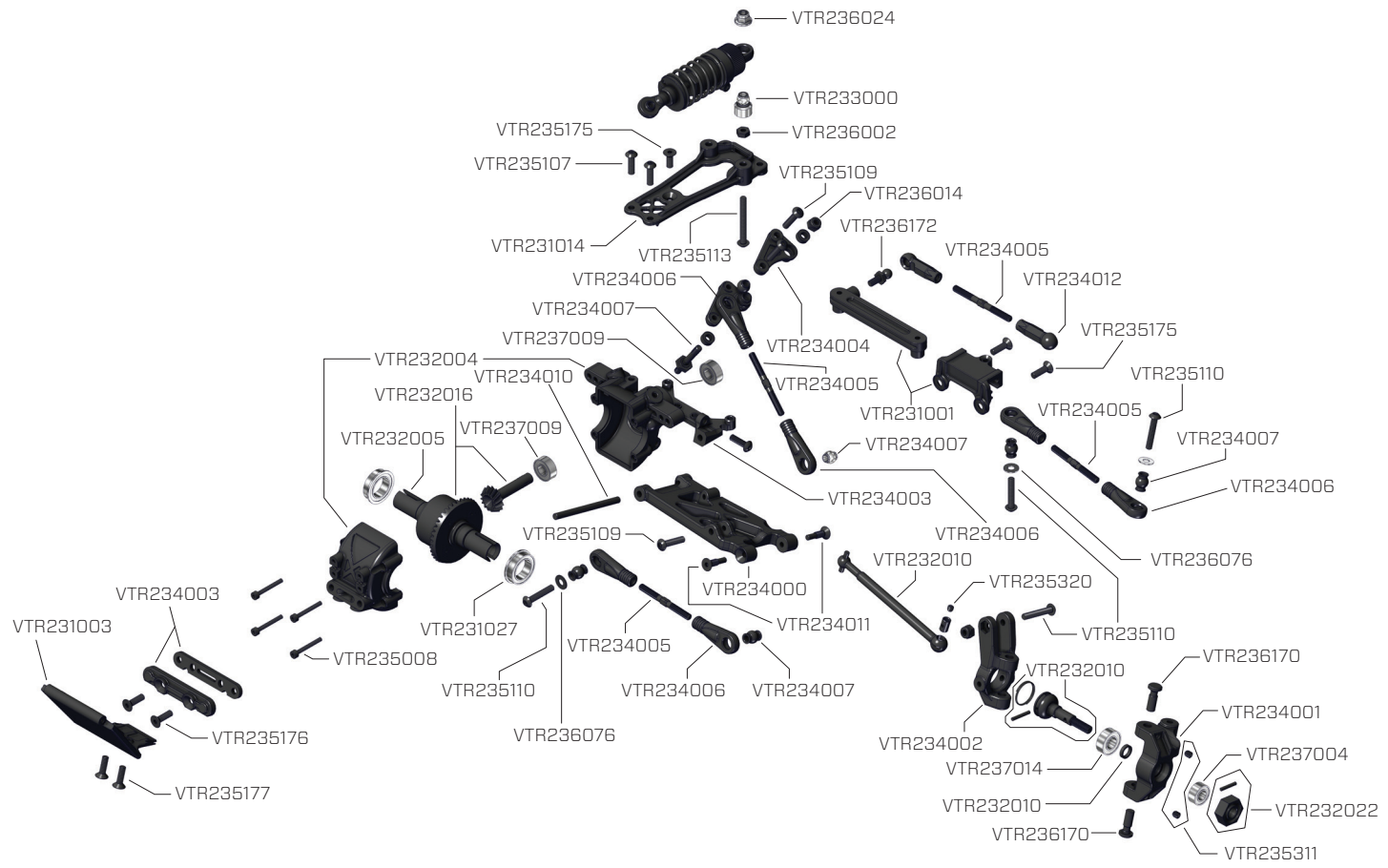

# CHASSIS // CHASSIS // CHÂSSIS // TELAI0 //////////////////////////////////////

Part #   Nummer Numéro   Codice	Description	Beschreibung	Description	Descrizione
SPMSR310	Waterproof Surface Receiver	Waterproof Surface Receiver	Récepteur étanche	Ricevitore impermeabile
SPMS605	9KG Servo, WP, Metal, 23T	Spektrum S605 9KG WP-Metall-Servo 23 Z	Servo 9Kg à pignons métal, étanche, tête 23T	Servo con ingranaggio in metallo 9kg, resistente all'acqua, 23T
VTR231000	Servo Arm and Mount Set	Vaterra Servoarm und Montage Set	Jeu de support et de bras de servo	Set supporti e squadrette servi
VTR231002	Rear Shock Towers & Fr Upright Brace	Vaterra Dämpferbrücken Hinten	Renforts de supports d'amortisseurs av/arr	Torri ammortizz. poster. e sostegno anter. superiore
VTR231004	Battery Tray & Spare Tire Mount	Vaterra Akkufach und Ersatzradhalter	Support de batterie avec support de roue de secours	Porta batteria e supporto ruota di scorta
VTR231005	Battery Strap	Vaterra Klettverschluss	Sangle de batterie	Fascette batteria
VTR231006	Chassis	Chassis	Châssis	Telaio
VTR234008	Rear Suspension Track Rod Mounts	Vaterra Monatsatz für Aufhängung hinten	Supports de tirants arrière de suspension	Supporto asta sospensione poster.
VTR234009	Rear Upper & Lower Track Rods	Vaterra Aufhängungssatz Oben/Unten	Tirants supérieurs et inférieurs arrière	Aste superiore & inferiore poster.
VTR235101	M2.5 x 16mm Button Head Screw	Vaterra M2.5 x 16mm Rundkopfschraube (10)	Vis à tête bombée M2,5x16mm (10)	M2.5 x 16mm viti a testa tonda
VTR236014	Ball Stud, 5.8mm x 10mm (10)	Vaterra M3 selbstsichernde Mutter 10)	Ecrou autofreiné M3 (10)	Sfere uniball, 5.8mm x 10mm (10)

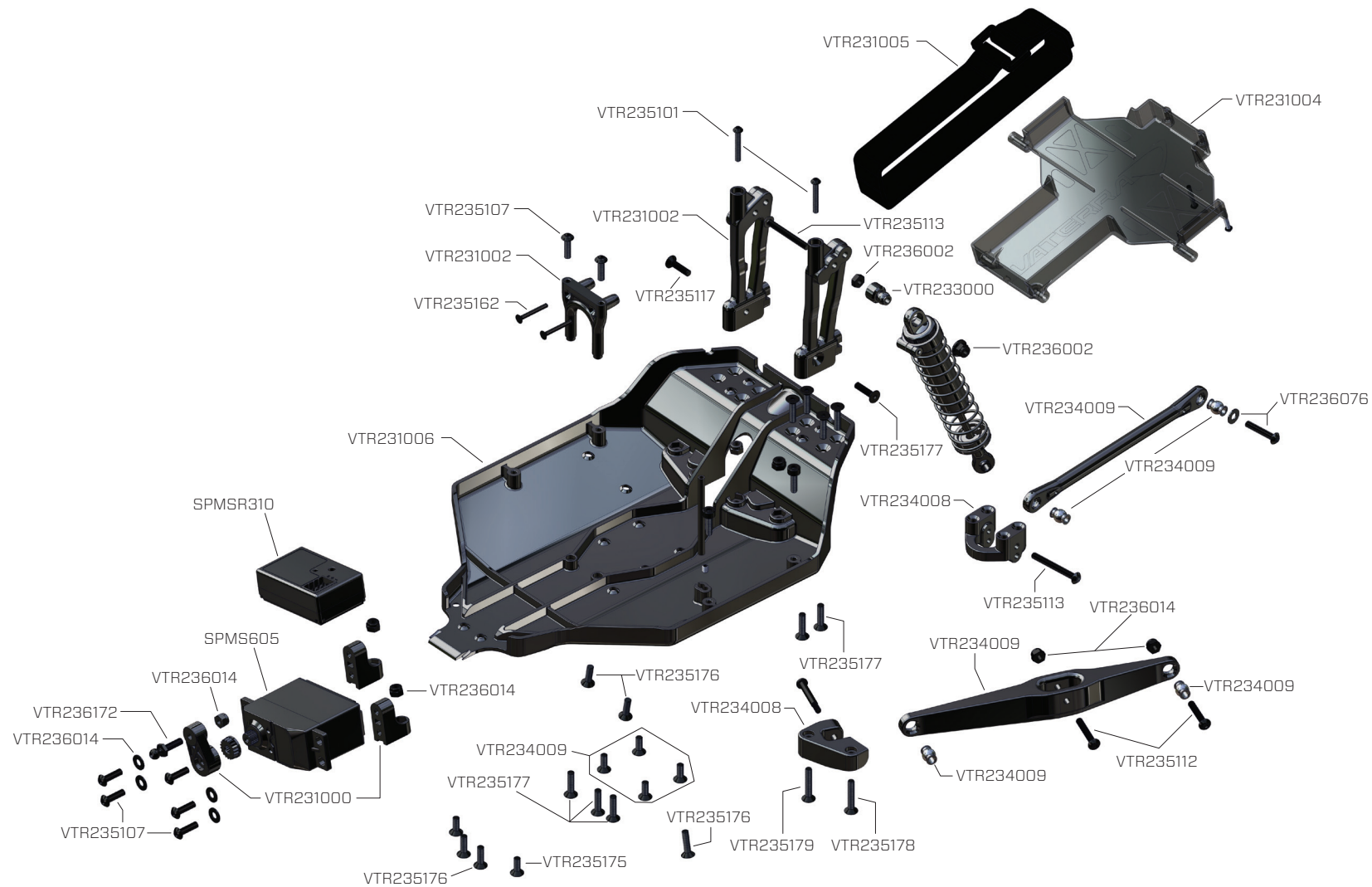



# REAR AXLE // HINTEN ACHSEN // AXES ARRIÈRE // ASSE POSTERIORE //////////////////////////////////////

Part #   Nummer Numéro   Codice	Description	Beschreibung	Description	Descrizione
VTR232002	Rear Center Diff Housing	Vaterra Diffgehäuse Hinten	Boitier de différentiel central arrière	Sede diff. centrale poster.
VTR232003	Rear Axle Tubes	Vaterra Steckachsen für Getriebe	Tubes d'axes de roues arrière	Tubi asse posteriore
VTR232012	Rear Axle Shafts (2)	Vaterra Radachsen Hinten (2)	Axes de roues arrière (2)	Alberi asse posteriore (2)
VTR232015	Fr/R Diff Housing	Vaterra Diffgehäuse Vorne/Hinten	Carter de différentiel av/arr	Sede diff. anter./poster
VTR232022	12mm Molded Hex Pins & Lock Nuts (4)	Vaterra Mitnehmerstift konisch mit Stopmutter	Ecrous frein et goupilles pour hexagone moulés 12mm (4)	Perni esagonali stampati 12mm e dadi autobloccanti (4)
VTR234008	Rear Suspension Track Rod Mounts	Vaterra Monatsatz für Aufhängung hinten	Supports de tirants arrière de suspension	Supporto asta sospensione poster.



# OPTIONAL PARTS // OPTIONALE BAUTEILE // PIÈCES OPTIONNELLES // PEZZI OPZIONALI // // // // //

Part #   Nummer Numéro   Codice	Description	Beschreibung	Description	Descrizione
VTR331000	Steering Servo Mount Set, Alum.	Vaterra Lenkservobefestigung Aluminium	Support de servo de direction en aluminium	Set supporto allum. per servo sterzo
VTR332001	Aluminum Transmission Shaft Set	Vaterra Antriebswelle Aluminium	Set d'arbres de transmission en aluminium	Set albero alluminio trasmissione
VTR332000	Locker, Front Diff	Vaterra Diffsperrle Vorne	Cale de verrouillage de différentiel avant	Bloccaggio differenziale anter.
VTR334000	Sway Bar Kit Front	Vaterra Stabisatz Vorne	Kit de barre anti-roulis avant	Kit barra oscillante anter.
VTR3340001	Sway Bar Kit Rear	Vaterra Stabisatz Hinten	Kit de barre anti-roulis arrière	Kit barra oscillante poster.
VTR334002	Rocker Arm Set Aluminum	Vaterra Schwingenset Aluminium	Set de basculeurs en aluminium	Set bilanciere alluminio
VTR334003	Front Spindles Aluminum	Vaterra Achsschenkel Aluminium	Fusées avant en aluminium	Alberini anter. alluminio
VTR334004	Front 15 Deg. Caster Black Set, Alum.	Vaterra Achsschenkelträger 15Grad Aluminium	Jeu d'étriers porte fusées en aluminium, 15°	Set nero caster 15° anter. alluminio
VTR233009	Rear Shock Spring Medium Silver (2)	Vaterra Feder h. Silber/Mittel (2)	Ressorts pour amortisseurs arrière, Moyens, argent (2)	Molle posteriori medie argento (2)
VTR233010	Rear Shock Spring Firm Green (2)	Vaterra Feder h. Hart/Grün (2)	Ressorts pour amortisseurs arrière, Durs, vert (2)	Molle posteriori dure verdi (2)
VTR233011	Front Shock Spring Soft Yellow (2)	Vaterra Feder v. Gelb/Weich (2)	Ressorts pour amortisseurs avant, Souples, jaunes (2)	Molle anteriori morbide gialle (2)
VTR233013	Front Shock Spring Firm Green (2)	Vaterra Feder v. Hart/Grün (2)	Ressorts pour amortisseurs avant, Durs, vert (2)	Molle anteriori dure verdi (2)